

Fan Coil Unit

Installation manual

AG***TN1DKH*

- Thank you for purchasing this Samsung Fan Coil Unit.
- Before operating this unit, please read this manual carefully and retain it for future reference.



SAMSUNG

Contents

Safety Information	3
Installation Procedure	7
Step 1 Checking and preparing accessories	7
Step 2 Choosing the installation location	7
Step 3 Optional: Insulating the body of the fan coil unit	10
Step 4 Installing the fan coil unit	10
Step 5 Purging inert gas from the fan coil unit	12
Step 6 Connecting the water pipes	13
Step 7 Performing the water leak test and insulating the piping	13
Step 8 Installing the water pipes	15
Step 9 Connecting the drain hose	17
Step 10 Connecting the power and communication cables	21
Step 11 Optional: Extending the power cable	25
Step 12 Setting the fan coil unit addresses and installation options	26
Step 13 Performing the test operation	39
Appendix	40
Troubleshooting	40

Safety Information

WARNING

- Hazards or unsafe practices that may result in severe personal injury or death.

CAUTION

- Hazards or unsafe practices that may result in minor personal injury or property damage.

General information

WARNING

Using the fan coil unit

- This product is for a centralized air conditioning control.
 - Failure to observe the following may cause condensation water to overflow, leading to water leakage.
 - Do not turn off the power switch although the product is not used for a long time.
 - Do not turn off the power switch immediately after stopping the operation.
 - Be sure to attach a valve to each of the piping inlet and outlet.
 - When operating the product for the first time, purge air by using the air vent valve. Failure to do so may result in poor performance and noise.
 - Do not insert the air vent hose into the drain hole of the drain plate. Failure to do so may cause water to overflow from the drain plate.
 - Be sure to insulate the piping.
 - Do not use any heat medium other than water.
 - When the product is not used for a long time, drain water.
 - Before operating the product, make sure that the control valve is open.
 - Be sure to keep the start operation sequence of fan coil ON → heat source ON and the stop operation sequence of heat source OFF → fan coil OFF.
- Observe the following to prevent condensation in summer:
 - Do not use the product in hot and humid places (relative humidity 80% or more). Water falling from the product may cause fire or property damage.
 - To ensure 24-hour flow of cold water, be sure to install a 2-way electric valve. If not installed, water overflow and condensation may occur. When the fan coil unit is stopped, the interworking control with the 2-way electric valve (valve closed) blocks cold water from circulating to prevent condensation inside the product. If no 2-way electric valve is installed, condensation water may be generated and condensation may develop inside the product.
 - When the heat source (chiller, boiler) is not used for more than 4 hours during the Cool mode, stop the water circulation. If the water circulation cannot be stopped, operate the fan at a low speed.
 - Observe the following to prevent the piping from freezing and bursting in winter:
 - Use a circulation pump to keep water running, or run a hot water boiler in intense cold weather.
 - If the product is not used for a long time, drain water from the entire system.
 - When a season ends, drain water from the entire system, including the heat exchanger and the piping.
 - When the supply water temperature is above 65 °C, the fan coil unit may enter the protection control mode (operation stopped) for product protection.

Before installing or maintaining the fan coil unit

- Be sure to disconnect all power sources before installation, service, or cleaning.

Installing the fan coil unit

- Make sure that installation must be performed by a qualified installer.
 - If the product is installed by the customer and if it is not installed completely, it may cause water leakage, electric shock, or fire.
- Install the product safely in a place that has enough strength to support the product weight.
- If the strength is insufficient, the product may fall off, causing personal injury.

Safety Information

- Make sure that there are no other products or objects under the fan coil unit.
 - Water falling from the product may cause fire or property damage.
- Electric work must be performed by a qualified electrician in accordance with the with the "local regulations" and "code" and this installation manual.
 - If the capacity of the power supply circuit is insufficient or the electrical work is performed incorrectly, it may cause electric shock or fire.
- For the power supply of the fan coil unit, use a dedicated power supply line of the rated power or more. In addition, do not extend the power cable arbitrarily.
 - If the connection is incomplete, it may cause fire.
- Be sure to arrange the electrical wires so that the structure of the electric device including the cover is not lifted, and secure the cover firmly.
 - If the cover is installed incorrectly, it may cause the terminal parts to overheat, leading to electric shock or fire.
- For the parts and tools used in installation, be sure to use the supplied accessories and the specified parts and tools.
 - Failure to use the supplied accessories and the specified parts may cause product malfunction, water leakage, electric shock, or fire.
- After the installation, be sure to check for water leakage.
 - After finishing the installation work, check that there is no water leakage. If water leaks contact with a fan, heater, or stove, etc., it may cause fire or property damage.
- Make sure that you earth the cables.
 - Do not connect the earth wire to the gas pipe, water pipe, lighting rod, or telephone wire. Incomplete earthing may cause electric shock or fire.
- Perform the installation work according to this installation manual.
 - Incomplete installation may cause water leakage, electric shock, or fire.
- After completing the installation, check the following before operating the product:
 - The piping is connected correctly and securely, and there is no water leakage.
- Do not modify and extend the power cable. Avoid complicated wirings.
 - Failure to do so may cause connection defect, insulation defect, or overcurrent, leading to electric shock or fire.
 - If you need to extend the power cable because it is damaged, follow "Extending the power cable" in this installation manual.
- Before performing electrical wirings for the fan coil unit, be sure to disconnect the main power
 - Failure to do so may cause electric shock.
- Depending on the installation location, an earth leakage breaker must be installed.
 - Failure to do so may cause electric shock.
- Do not modify the product arbitrarily.
 - Failure to do so may cause product malfunction, electric shock, fire, or personal injury.
- When the fan coil unit is fixed inside the ceiling, be careful that the power cable, water pipes, and electric parts are not subject to water or external impact.
- Be sure to connect the power cable to an auxiliary circuit breaker (ELCB, ELB, MCCB) dedicated to the fan coil unit.
 - If a dedicated auxiliary circuit breaker (ELCB, ELB, MCCB) is not installed, the power supply may not be cut off in case of over current or current leakage, leading to electric shock or fire.
- Make sure that the wiring is securely connected using the specified wires, and securely fix the wires so that no external force from them is applied to the terminal connection part.
 - Incomplete connection or fixation may cause heat or fire.
- Be careful that the room power supply is not out of the voltage range (minimum voltage to maximum voltage).
 - Failure to do so may cause damage to electrical parts or degradation to part performance, leading to product malfunction.

After installing the fan coil unit

- After completing the installation, be sure to check for leakage from the water pipes.

CAUTION

- Before starting the installation, be sure to carefully read this installation manual.
- Make sure that the product is transported to the installation site with being packed. After reaching the installation site, if you need to remove the package and transport the product, use soft materials to prevent damage to the product during transportation.
- Be sure to install the drain pipe according to the installation manual so that the drainage is reliable.
 - If the piping is installed incompletely, it may cause water to penetrate indoors and household items to get wet.
- Tighten the nuts using a torque wrench according to the specified method.
 - If the nuts are tightened too tightly, they may break after a long period of time, leading to water leakage.
- Wear gloves (thick gloves such as cotton work gloves) during installation.
 - Failure to do so may cause personal injury due to parts.
- Do not install or operate the fan coil unit in the following places:
 - Where there is a mixture of mineral oil or oil vapors are generated, (If the oil is attached to the heat exchanger, it may cause performance degradation, spraying, or scattering of condensation. If the oil is attached to plastic parts, it may cause deformation or breakage to them. This may result in product malfunction or water leakage.)
 - Where corrosive gases such as sulfur gas are present (Because copper pipes and brazed parts may be corroded in these places, additional corrosion protection and rust preventive application are required. Contact a facility specialist.)
 - Where exposed to combustible gas, carbon fiber, flammable powder, or dust, or where volatile combustion gases such as thinner or gasoline are used (Gases near the fan coil unit may ignite.)
 - Where electromagnetic interferences are generated (The control unit may not operate.)
 - Where the air contains a high level of salinity, such as near the sea, or where voltage fluctuates significantly, such as in factories, or in vehicles or ships,
 - Where obstacles that disturb the air flow, such as ventilation openings or lighting fixtures, are near the product (The disturbed air flow may cause performance degradation or stopping of the unit.)
 - Where a special spray is used frequently.
 - Do not install the product in a hair salon or other similar places because hairspray ingredients may reduce the hydrophilic property in product's heat exchange, causing condensation on the panel and the air flow blades in the Cool mode.
 - Where fine powder is used (baking room, etc.)
 - Do not use the product for unintended purposes, such as preservation of precision equipment, foods, animals, plants, cosmetics, art works, etc. (Failure to do so may cause property damage.)
 - Where corrosive gases such as sulfur dioxide are generated, such as toilet exhausts or vent outlets (Because copper pipes and brazed parts may be corroded in these places, additional corrosion protection and rust preventive application are required. Contact a facility specialist.)
 - Where flammable gases may leak, carbon fiber or flammable dust floats, or other volatile flammable materials such as thinner and gasoline are treated (If gas leaks and remains around the product, it may cause ignition.)
 - Where the fan coil unit may be corroded, such as coastal areas and hot springs.





Safety Information

- When choosing the installation location, refer to the pattern sheet.
- Do not install the product in a place where a constant temperature and humidity (year round cooling) is required, such as a server room, machine room, and computer room.
 - Failure to do so may cause reliability problems because these places are beyond the product warranty.
- After finishing the installation, perform a test run to confirm that there is no abnormality, and explain to the customer how to use and care the product according to the user manual. In addition, tell the customer to keep both of the user manual and this installation manual.
- Before starting the installation, make sure that there are no problems with the product.
 - Do not install the product if it has been scratched during transportation.
- Perform the drainage work as described in this installation manual so that condensation water can be reliably drained, and insulate the drain pipe so that no condensation can be generated.
 - Incomplete drainage work may cause water leakage, leading to property damage.
- Install the power and communication cables of the fan coil unit at least 1 m away from other electronic appliances and at least 2 m away from the lightning rod lead wires.
 - However, depending on the radio wave conditions, noise may be generated in other electronic appliances even if they are 1 m or more away from the product.
- Install the fan coil unit at a place away from lighting fixtures that use ballast stabilizers as much as possible.
 - When the wireless remote control is used, remote control signals may not be received correctly due to the ballast stabilizers of the lighting fixtures.

Installation Procedure

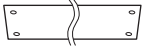
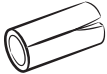
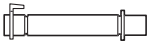
Step 1 Checking and preparing accessories

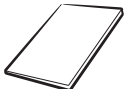
The following accessories are supplied with the product.

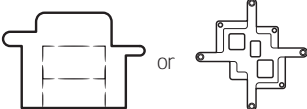
Pattern sheet A (1) Pattern sheet B (1)	Insulation pipe (2)
	
Flexible hose (1)	Insulation drain (1)
	
Rubber	Manual (2)
	
Cable-tie (3)	Air vent hose (1)
	
Installation gauge (1)	
	

Step 2 Choosing the installation location

Installation location requirements

- Air must be distributed optimally.
- The passage of air must not be disturbed.
- Condensation water must be drained easily.
- The support structure must be strong enough to support the weight of the fan coil unit. (If the structure is not strong, the fan coil unit may fall off, leading to personal injury.)
- The ceiling must not be significantly sloped.
- There must be a sufficient space for maintenance and service.
- The power and communication cables of the fan coil unit must be at least 1 m away from electronic appliances such as televisions. (Occasionally, more distance may be required.)

Reinforcing the ceiling

Make sure that the ceiling is sufficient to support the weight of the fan coil unit. If dangerous, reinforce the ceiling with foundation bolts before installing the fan coil unit.

Spacing requirements

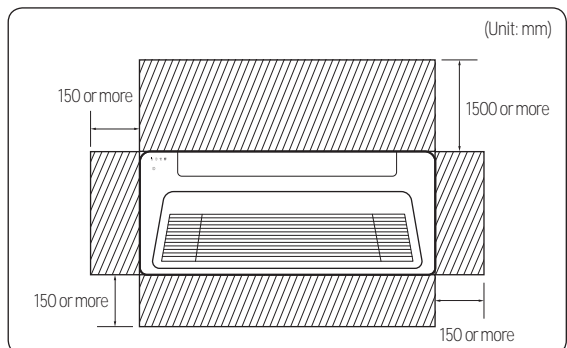

Installation Procedure

Dimension of the fan coil unit

Slim 1 way cassette (Medium)

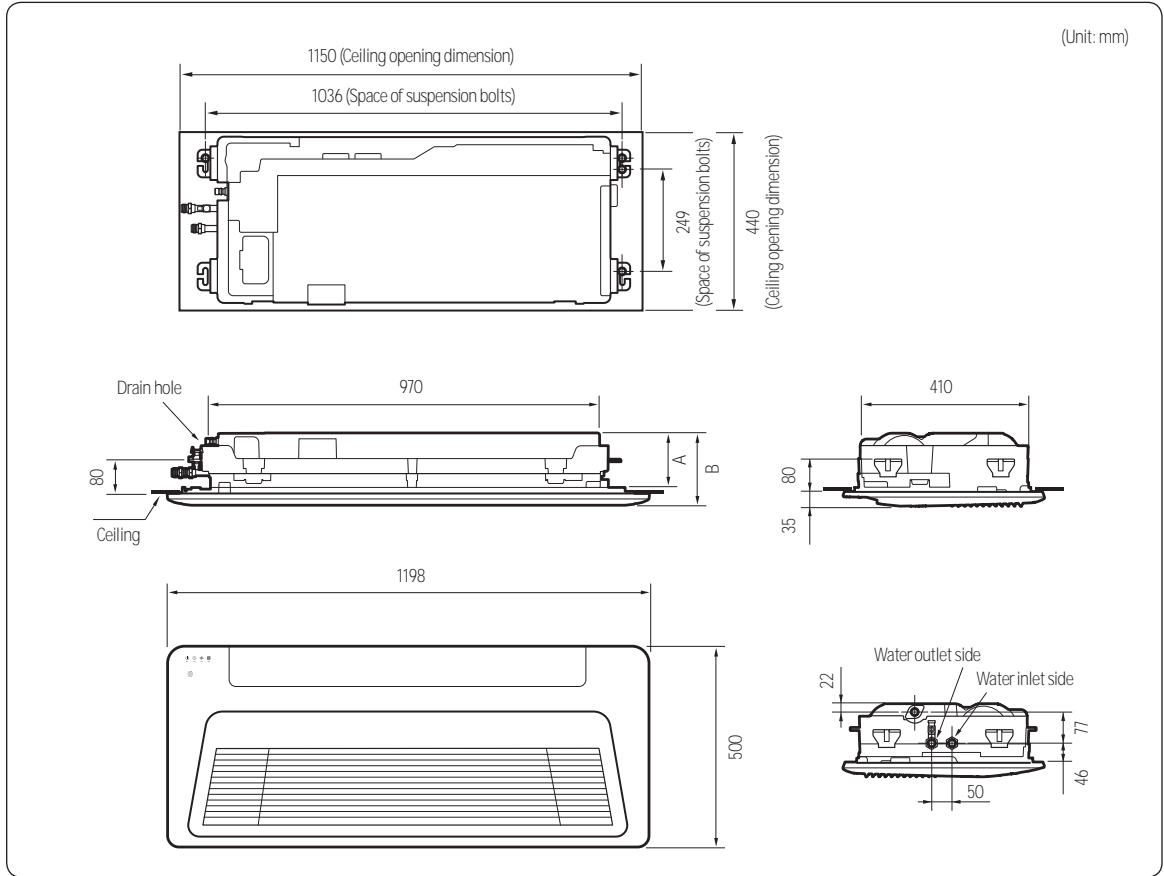

Model	AG026TN1DKH* / AG032TN1DKH*
A	135
B	175
Connection port	PF Male (3/4")
Flexible hose connection port	VP20 (outer diameter: Ø 26, inner diameter: Ø 20)

Slim 1 way cassette (Large)

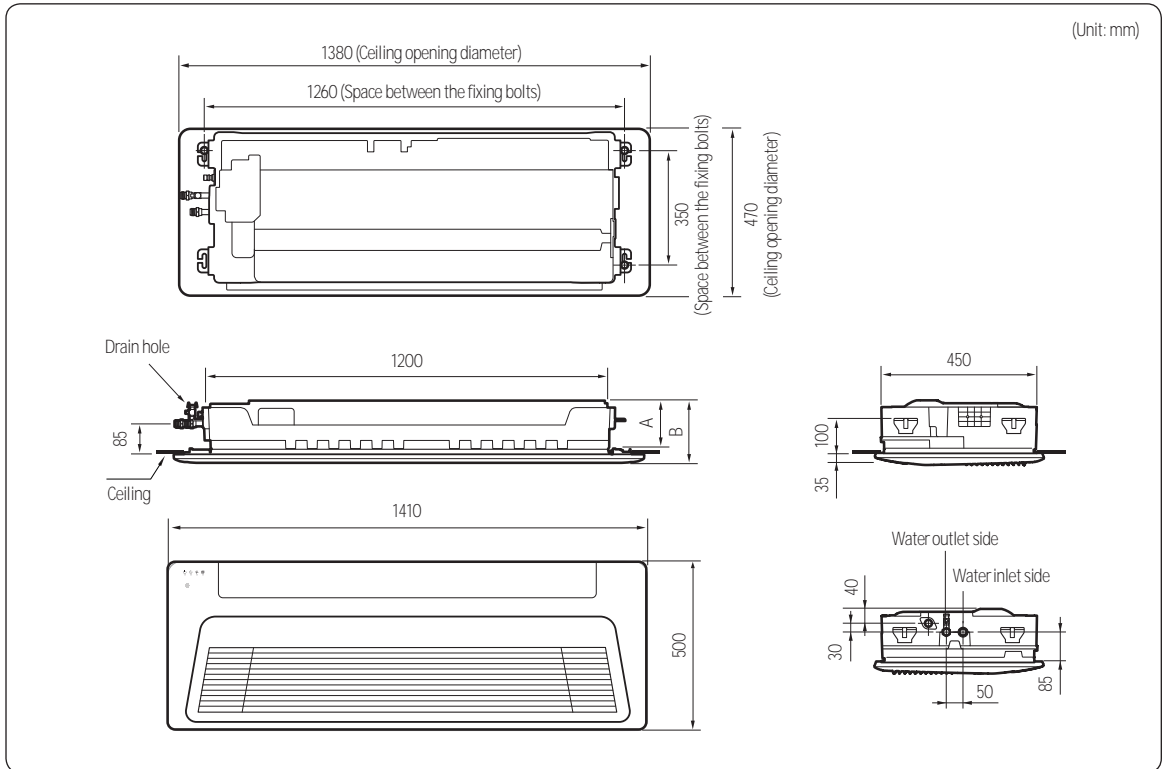

Model	AG042TN1DKH*
A	138
B	180
Connection port	PF Male (3/4")
Flexible hose connection port	VP25 (outer diameter: Ø 32, inner diameter: Ø 25)

NOTE

- The shape of the fan coil unit may differ depending on the model.
- When installing a cassette type product on a ceiling with a temperature of 27 °C or more and a humidity of 80% or more, install polyethylene foam or a similar insulation material with a thickness of 10 mm or more onto the fan coil unit body.
- The recommended ceiling height is 2.7 m.

Installation Procedure

Step 3 Optional: Insulating the body of the fan coil unit

Insulation guide

- For the pipe inlet and outlet and some bent parts, cut out and shape the insulation material in accordance with their shape.
- Be sure to insulate the air inlet and outlet (front and rear) together when insulating the connecting ducts.

Step 4 Installing the fan coil unit

Preparations for installation

The piping that will be connected to the fan coil unit must be completed before installation.

- 1 Check the product to install and its installation location.
- 2 Check the following installation requirements:
 - When the product is installed on the ceiling, check the strength of the ceiling first.
 - When the product is installed on the ceiling, use the pattern sheet.
 - After making the mounting hole on the ceiling, keep the ceiling surface level.
 - You may need to reinforce the ceiling to prevent the product from causing the upper floor to vibrate.
- 3 Drill holes on the ceiling or the ceiling support, and then insert the foundation bolts, as shown in the following figure:
 - Use bolts of $\varnothing 9.52$ or M10 size and of 1.5 m or less length.
 - Install at least four foundation bolts so that the fan coil unit can be fixed firmly.
 - When the existing ceilings require reinforcement, use anchor holes.
 - For new ceilings, use sunken inserts, sunken anchors, or other commercially available parts.

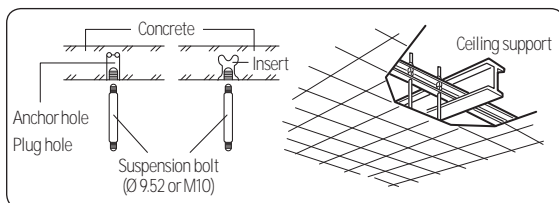

⚠ CAUTION

- Purchase all the needed parts from the market.
- Because the pattern sheet is made of paper, it may shrink or stretch slightly due to temperature or humidity. Therefore, before drilling holes on the ceiling, be sure to check the correct dimensions.
- Be sure to secure a sufficient space that allows for access for maintenance or repairs.

Installing on a new ceiling

- 1 Place the pattern sheet on the ceiling at the spot where you want to install the fan coil unit.

📄 NOTE

- Because the pattern sheet is made of paper, it may shrink or stretch slightly due to temperature or humidity.

Take the following steps to install one or more inspection holes according to the panel type.

- **For installing a ceiling type square panel**

Install an inspection hole along the direction of connection parts of the water pipe and the drain hose. (1 point)

- **For installing a ceiling type circular panel**

Install an inspection hole along direction of the connection parts of the water pipe and the drain hose and another along the direction of the fan coil unit display. (2 points)

- 2 Drill holes on the ceiling or the ceiling support, and then insert the foundation bolts, as shown in the following figure:

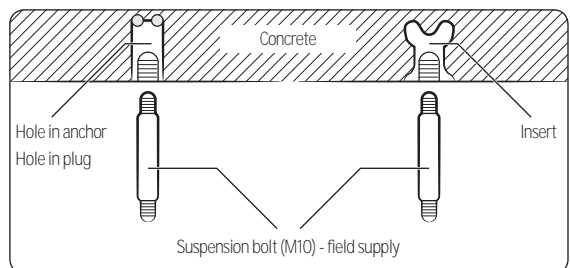

- 3 Install suspension bolts, depending on the ceiling conditions.
 - Before hanging the fan coil unit, make sure that the ceiling is strong enough to support the weight of the unit. Test the strength of each suspension bolt installed.
 - Install the suspension bolts in various ways suitable for the type and material of the ceiling. Anti-vibration treatment is required when the ceiling fixing bolt is 1.5 m or more.

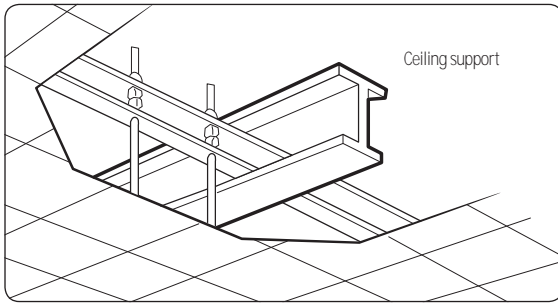

- 4 Secure a total of 8 nuts and washers to each suspension bolt. However, leave a little space between the nuts into which the hanger bracket of the fan coil unit will be inserted.
 - At this time, if you cut the stopper pad and insert it under the upper washer, the washer will not flow down, making the installation easier.
 - For installation of the fan coil unit, be sure to install at least four suspension bolts.

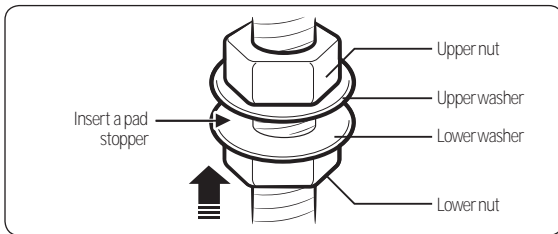

- 5 Insert a hanger bracket between the nuts fixed to each suspension bolt to hang the fan coil unit.
 - When installing the product, be sure to install the piping inside the ceiling. When an existing ceiling is used, install the piping inside the ceiling before installing the fan coil unit.

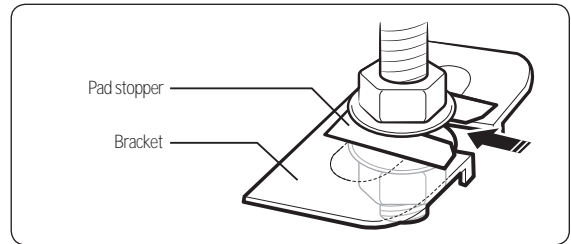

- 6 Tighten the nuts to firmly fasten the fan coil unit.
- 7 Adjust the position of the fan coil unit while considering the space for installing the front panel.
 - Remove the jig made in the pattern sheet, and then use the jig to adjust the space between the ceiling and the fan coil unit, as shown in the figure below.
 - If not installed in alignment with the jig, noise may occur.
 - Adjust the position of the fan coil unit in alignment with the jig.
 - Adjust the level of the fan coil unit by using a leveler, and then fix the unit securely.
 - First, fix the front panel with the panel fixing bolts, and then install the front panel so that it comes in close contact with the fan coil unit body.

Installation Procedure

When the installation template is made of paper

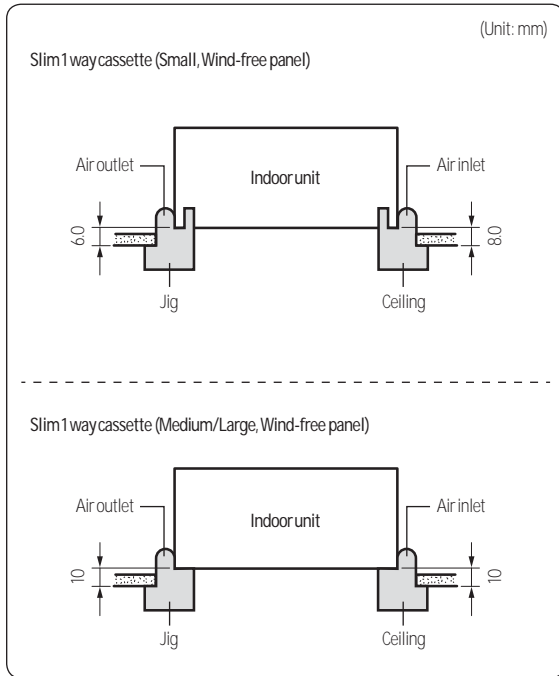

When the installation template is made of plastic

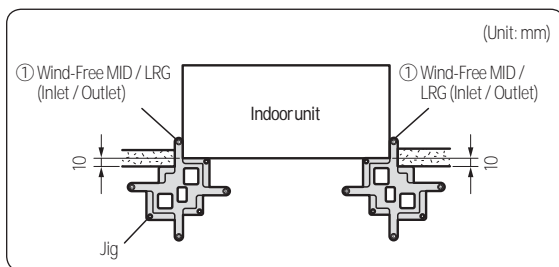

- 8 After installing the fan coil unit, be sure to cover it with the fan coil unit protection vinyl to prevent any paint or dust from entering the unit until the panel is fixed.

⚠ CAUTION

- If dust or paint enters the unit, it may degrade the product performance or cause product malfunction.

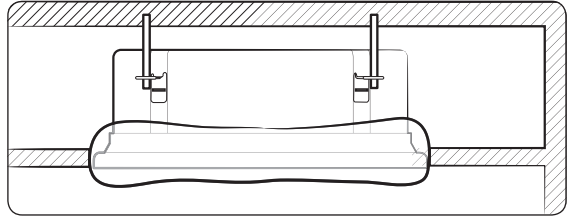

Step 5 Purging inert gas from the fan coil unit

The fan coil unit comes with nitrogen gas (inert gas) charged at the factory. Therefore, all inert gas must be purged before connecting the water piping.

Open the sealed tube at the end of the piping. The gas in the piping comes out.

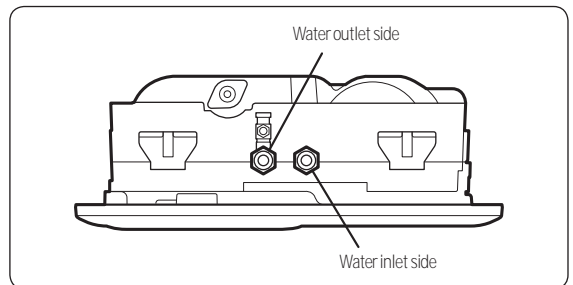

Be sure to check the water inlet and outlet locations.

⚠ CAUTION

- To prevent dirt or foreign objects from getting into the pipes during installation, purge nitrogen gas (inert gas) immediately before connecting the piping.
- If nitrogen gas (inert gas) is not purged when you rotate and open the sealed tubes at the end of the piping, do not install the fan coil unit because it is an abnormal one.

Step 6 Connecting the water pipes

- 1 Purge inert gas.
 - The fan coil unit comes with nitrogen gas (inert gas) charged at the factory for protection of the unit during transportation. Remove the protective caps from the piping to purge inert gas.

CAUTION

- To prevent foreign objects from entering the piping, do not remove the cap until the piping connection is ready.
- 2 Connect the pipes.
 - Be sure to use a metal pipe for the piping outlet.
 - Be careful not to erroneously change the piping inlet and outlet connections. (Outlet: air vent valve)
 - Be sure to attach a valve to each of the piping inlet and outlet.
 - Be sure to insulate all of the water pipes and the drain pipe.
 - The maximum operating water pressure of the fan coil is 1.0 MPa. Design your air conditioning system so that the operating water pressure becomes 1.0 MPa or less.
 - Design the piping so that air clogging does not occur.
 - Use Teflon tape on the T-type screws to prevent water leakage.

Step 7 Performing the water leak test and insulating the piping

- 1 Perform the water leak test.
 - Make sure that there is no water leakage from the water pipes connected to the fan coil unit.
- 2 Insulate the pipes.
 - After confirming that there is no leakage from the water inlet and outlet pipes and the drain pipe, insulate all of them.
 - First, insulate the 2 way electric valve before insulating the water inlet and outlet pipes. (Covered by the installation site)
 - After the valve insulation is completed, insulate the water inlet and outlet pipes and the drain pipe.
- a Choose insulation materials suitable for the pipes.
 - Consider the insulation thicknesses suitable for different pipe diameters.
 - The general criterion for choosing insulation materials is that it withstands less than 85% humidity at 30 °C temperature. If humidity is higher than this general condition, choose one step higher criterion from the following table:

Pipe	Pipe diameter (mm)	Insulation materials [heating and cooling (mm)]		Remarks
		General condition ¹⁾ (less than 85 % at 30 °C)	High humidity condition ²⁾ (more than 85 % at 30 °C)	
		EPDM, NBR		
Water pipes	Ø15.88	19 t	32 t	Heat resistance temperature: 120 °C or more

- ¹⁾ When installing the piping in locations and environments that meet the following conditions, use the same insulation for the general condition.
- When humidity inside the ceiling tex is high even if it is cooled.
 - When the room ceiling is high (for example, a large church chapel, theater, multi-story open lobby, staircase classroom) and there is a large difference between the temperatures at the floor and ceiling.

Installation Procedure

- Uncooled corridors and passages
- Old buildings with insufficient insulation
- Common urban buildings (apartments, houses, classrooms, private educational institutes, offices, general shops, etc.)
- Open structures without ceiling tex
- Structures without ventilation systems, although its has ceiling tex
- Structures where the piping is embedded in the wall and no external air flows into it

2)* When installing the piping in locations and environments that meet the following conditions, use the same insulation for the high humidity condition.

- Geographical conditions
 - High humidity areas such as coastal areas, hot springs, areas adjacent to a lake or river, ridges where part of the building is covered with soil
 - Areas where morning dew occurs frequently (once every three days)
- Usage conditions
 - Dining rooms, saunas, swimming pools, restaurants etc.
- Building structure conditions
 - When installing the piping inside a ceiling where there is a lot of water inflow and cannot be cooled(locations near a corridor and entrance of a dormitory or an efficiency apartment)
 - Locations with a high humidity due to poor ventilation in the piping installation space
 - Semi-basement rooms

NOTE

- If you are unclear about which insulation you should choose, choose the one for the high humidity condition.
- If the use of the room is expected to be changed, reconsider the insulation thickness.
- Be sure to use only the specified insulation materials.

b Insulate the piping.

- Incorrect piping insulation may cause condensation on the piping surfaces or degrade the product performance.
- Make sure that the bent parts of the piping are correctly covered with insulation.

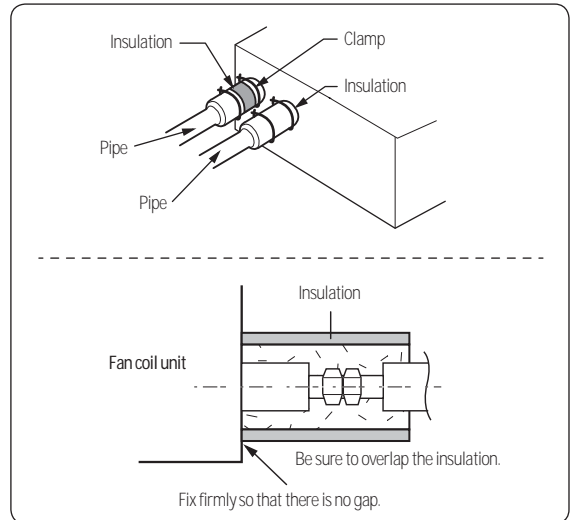

Short piping system

- You can use joined insulation (joining the pipes and insulating them together), but avoid excessive pressing.
- When joined insulation is used, apply the insulation thickness one step higher.

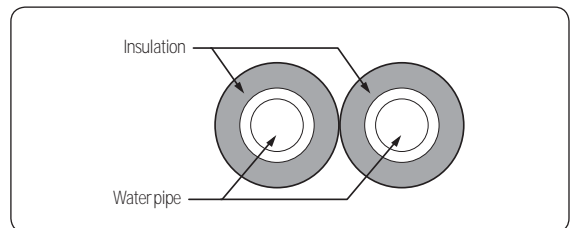

⚠ CAUTION

- Make sure that the pipe insulation is free of gaps and cracks, and apply adhesives specific to the insulation joints so that moisture cannot enter through them.
- If the pipe insulation is exposed to the sun's ultraviolet rays, wind tape around the insulated pipe as a finishing work. (When winding tape, be careful not to reduce the thickness of insulation.)
- Be careful not to reduce the thickness of the insulation at the bent parts of the pipe, the pipe hanger, etc.
- If the thickness of insulation is reduced, apply additional insulation to compensate the thickness.

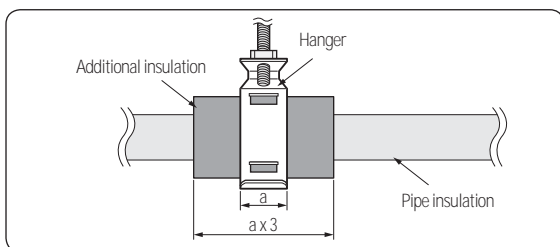

Step 8 Installing the water pipes

- 1 Remove the caps from the water pipe inlet and outlet.

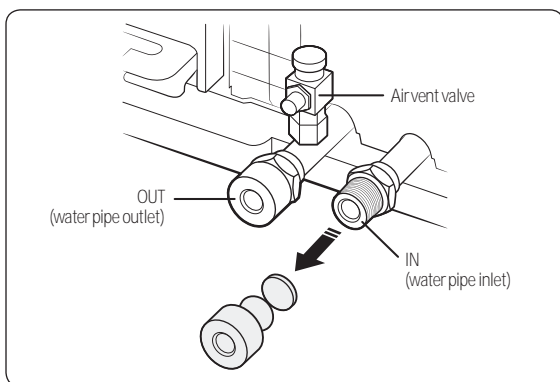

- 2 Be sure to check the positions of the water pipe inlet and outlet of the fan coil unit by finding their labels (IN and OUT) attached.
 - The water pipe inlet label is printed with IN and the water pipe outlet label with OUT.
 - Note that the air vent valve is attached to the side where you can find the water pipe outlet.

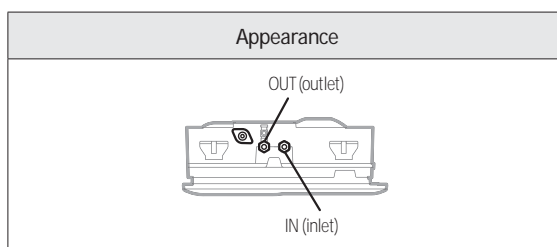

⚠ CAUTION

- Failure to connect the water pipes may cause performance degradation.
 - Be sure to insulate both the inlet and outlet pipings.
- 3 Before connecting the water pipes, be sure to install a 2-way electric valve.
 - Be sure to install the 2-way electric valve on the inlet side pipe.
 - When circulating cold/hot water, open the air vent valve and use a tube to receive water so that the air inside the pipe and coil is sufficiently removed, and then close the valve. Failure to do so may cause performance degradation and noise.
 - Before connecting the water pipes., check if the water pipe Flexible tube (loose nut PF 3/4") specification is correct. After connecting the water pipes, remove foreign objects from them, and then circulate water to check for water leakage.

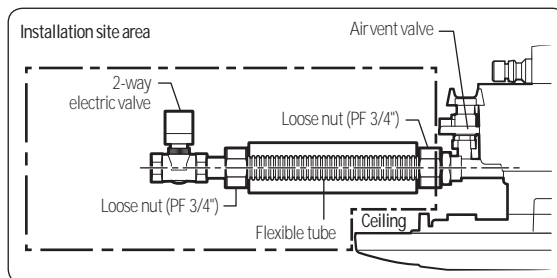

Installation Procedure

⚠ CAUTION

- Be sure to install a 2-way electric valve on the water pipe inlet of the fan coil unit.
Failure to do so may cause condensation and product malfunction.
- Attach a 40 mesh strainer to the inlet piping (Installation site area)
- If there is no strainer installed, foreign objects may enter the pipe, causing malfunction and performance degradation to the 2-way electric valve, condensation, or water leakage, etc.
- When the temperature of intake water is higher than 65 °C, the protection control of the product may be activated.
- If the outside temperature is lower than 0 °C during winter, the inside of the heat exchanger may freeze and burst. To prevent this, operate a water pump and operate the product to open the 2-way electric valve.
- When the product is not used for a long period of time in winter, drain all the water from the heat exchanger and the entire water piping system.
- If both the room temperature and the piping temperature are 5°C or less, the 2-way electric valve automatically opens to prevent freezing and bursting.
- Use frost preventive additives to prevent the circulating water from freezing in winter.
- Check if the rated flow rate is being supplied.
Low flow rates may cause performance degradation or product malfunction.

- 4 Wind Teflon tape (10 to 15 times) around the threads of the water pipe inlet/outlet Flexible tube of the fan coil unit in the thread direction.

⚠ CAUTION

- When connecting the pipes, tighten sufficiently with a monkey wrench and a torque wrench as shown in the figure above. Failure to do so may cause water leakage.
- When operating the product for the first time or restarting it after a long period of stoppage, open the air vent valve of the heat exchanger and use a tube to receive water so that the air inside the pipe and coil is sufficiently removed, and then close the valve.

- 5 Manage water quality in accordance with the following water quality standards for refrigeration equipment:

⚠ CAUTION

- If water quality is not managed in accordance with the water quality standards, corrosion and scales may develop, which may shorten the life of the product and cause performance degradation and lead to a serious product malfunction.

	Item	Cold water	Corrosion	Scales
Reference value	PH(25°C)	6.5-8.0	0	-
	Conductivity (25 °C, μS/cm)	200 or less	0	-
	Alkalinity (PPM)	50 or less	-	0
	Hardness (PPM)	50 or less	-	0
	Chlorine ion (PPM)	50 or less	0	-
	Sulfate ion (PPM)	50 or less	0	-
	Iron (PPM)	0.3 or less	0	-
	Sulfur ion (PPM)	Not detected	0	-
	Ammonium ion (PPM)	0.2 or less	0	-
	Silica (PPM)	30 or less	-	0

- 6 Check the rated flow rate of cold / hot water and the pressure loss inside the heat exchanger.

⚠ CAUTION

- If the rated flow rate is not supplied, it may cause performance degradation and product malfunction.

Category	Mode	Rated flow (LPM)	Pressure drop (kPa)
Slim 1 way cassette	AG026TN1DKH*	7.5	23.0
	AG032TN1DKH*	9.6	34.5
	AG042TN1DKH*	11.9	45.0

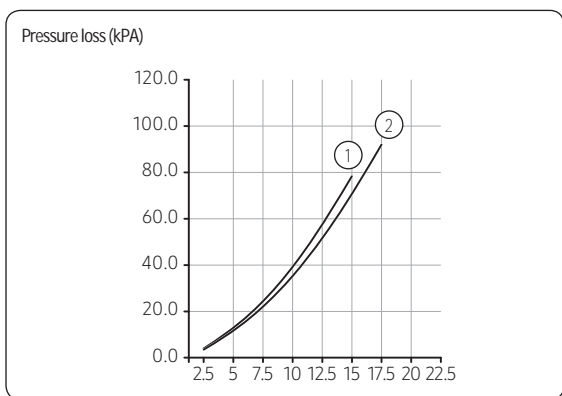

1	Slim 1 way cassette	AG026/032TN1DKH*
2	Slim 1 way cassette	AG042TN1DKH*

Step 9 Connecting the drain hose

- Drain hoses and PVC pipes are sold separately.
 - Before installing the drain pipe, be sure to check if drainage is good.
- 1 Connect the flexible hose to the drain port of the fan coil unit.
 - Make sure that a rubber ring is assembled at the connection port.
 - Securely fasten the flexible hose until you hear "click."
 - The position of the connection port may differ depending on the fan coil unit model.

- 2 Fix the drain pipe to the opposite end of the flexible hose.
 - Fix the connection part of the flexible hose and the drain pipe (PVC) with adhesive for PVC.
 - After the adhesive for PVC is completely hardened, check whether water leaks from the connection part.
 - Water pipe specifications
 - Slim 1 way cassette (Small): VP20 (OD: ϕ 26, ID: ϕ 20)
 - Slim 1 way cassette (Large)/ 4 way cassette / 360 cassette: VP25 (OD: ϕ 32, ID: ϕ 25)

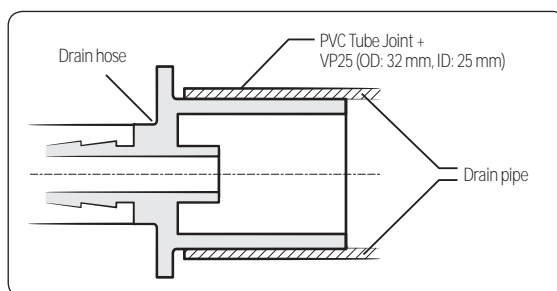

- 3 Shorten the connection length of the drain pipe as much as possible.
 - Install the drain pipe so that it is sloped downward (3 mm or more) for proper drainage of condensation water.
 - Use a cable tie to secure the connection part so that the flexible hose and the drain pipe are not separated.
 - Be sure to insulate the piping, contact area, and drain pipe.

⚠ CAUTION

- After installing the fan coil unit, be sure to insulate the pipe, piping connections, and drain pipe.

Installation Procedure

- 4 Fully insulate the drain pipe inside the building (on site). If the drain pipe is sloped insufficiently, install the drain pipe vertically from the hose connection port (on site).

⚠ CAUTION

- When connecting the flexible hose to the main drain pipe, make sure that the elbow is installed vertically. (Horizontal installation is prohibited.)

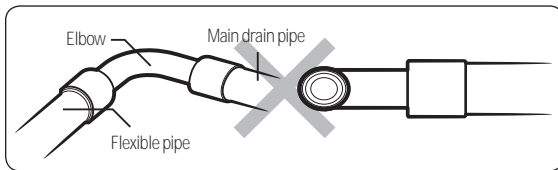
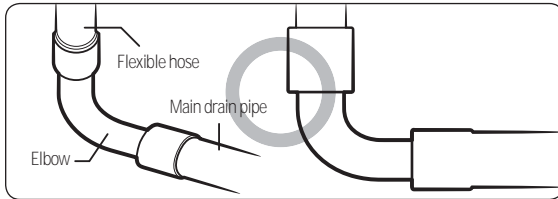

- 5 Remove the accessory vinyl attached to the drain pan. Connect the air vent hose, and then secure it with a cable tie so that it does not come out.

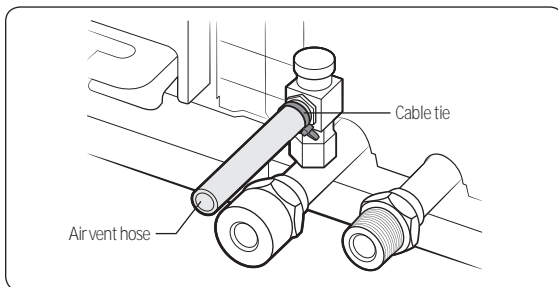
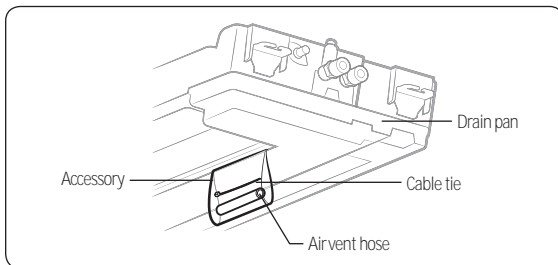

Individual drainage

Use a leveler to check that the fan coil unit is parallel to the ceiling.

- 1 If the slope of the drain pipe is less than 1/100, be sure to install an air vent at the inlet of each drain hole to smooth the flow of condensation water.
- 2 If the drain pipe is installed higher than the connection port, install the drain pipe vertically within a distance of 300 mm from the flexible hose connection port. (Slim 1 way cassette)
 - However, because the water may leak, the height of the drain pipe should not exceed 550 mm.
- 3 Install the drain pipe at a slope of 1/100 or more.
- 4 Make sure that the distance between the supports is 1 to 1.5 m.
- 5 In order to prevent odor from the outlet of the drain pipe, install a trap at the end of the drain pipe or install an indirect drain.
- 6 Do not apply force to the hose when connecting the drain pipe.
 - Make sure that the hose connection is not loosened and as close as possible to the wall or other support, as shown in the figure.

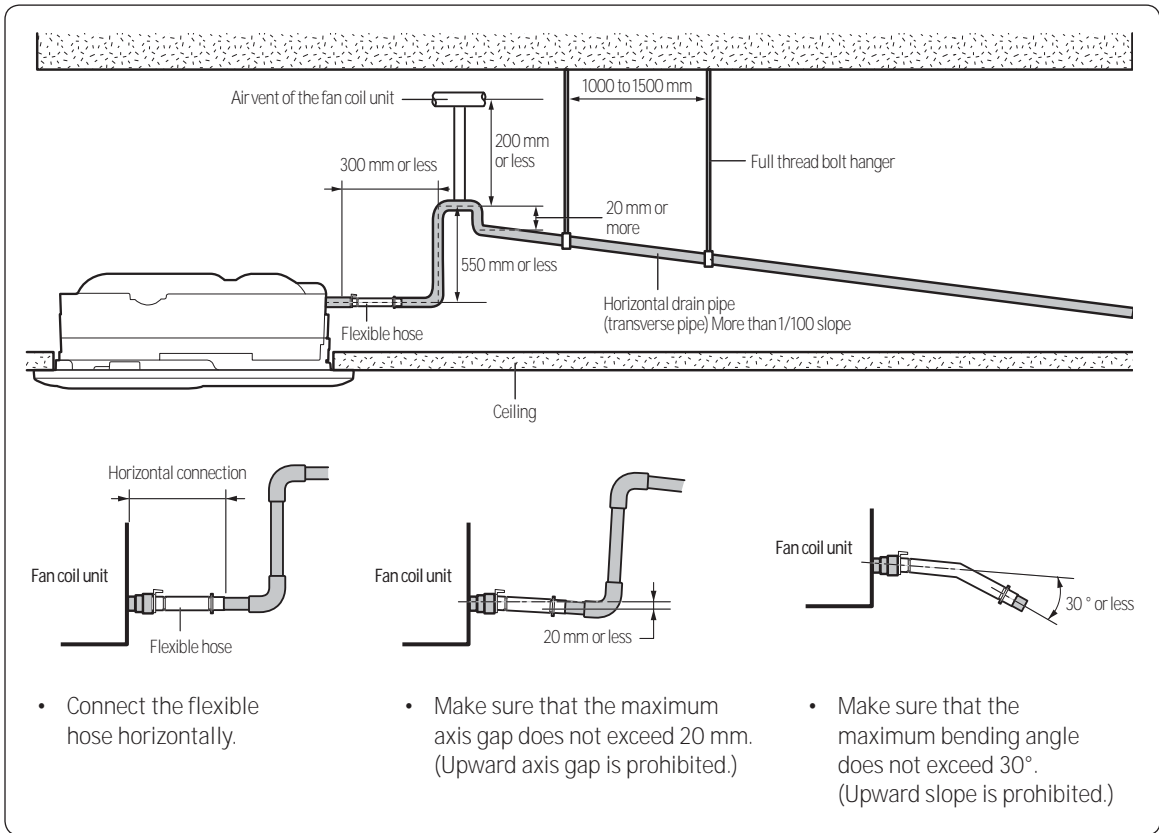

Concentrated drainage

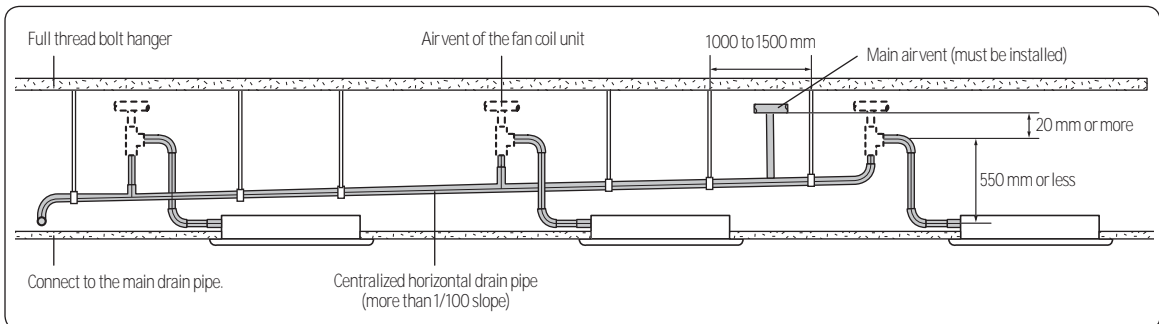

- 1 If 3 or more fan coil units are installed, install the main air vent at the front of the farthest fan coil unit from the main drain pipe.
- 2 If the slope of the centralized horizontal drain pipe is less than 1/100, be sure to install an air vent at the top of each fan coil unit to prevent water from flowing back to the unit.

Installation Procedure

Performing the drainage test

- 1 Do a leak test at the connection part of the flexible hose and the drain pipe (PVC):
 - a Connect a general hose to the connection part of the flexible hose of the fan coil unit, and pour in some water.
 - b After pouring some water, reassemble the rubber cap on the connection part of a flexible hose of the fan coil unit and firmly tighten it with a band to prevent leakage.
 - c Check the leak test at the part where the adhesive for the flexible hose and the drain pipe (PVC) is used.

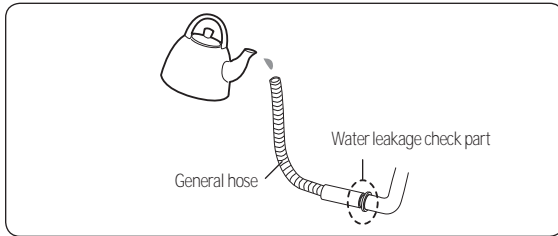

CAUTION

- The leak test must be performed for at least 24 hours.
- 2 Check the condensation water drainage:
 - a Pour water into the fan coil unit drain pan or the drainage port as shown in the figures below.
 - Slim 1 way cassette: about 1 ℓ

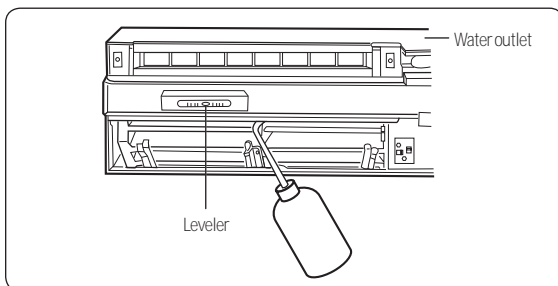

When the electric cable connection is completed

- Turn on the fan coil unit.
- Operate in the Cool mode.

NOTE

- Only in the Cool mode, you can check the correct operation of the drain pump.

When the electric cable connection is not completed

- Remove the control box cover of the fan coil unit.
- Connect the power supply (single phase, 220 to 240V) to the L and N terminals.
- Reassemble the control box cover and turn on the fan coil unit.

NOTE

- When the float switch is not detected due to insufficient water on the drain pan, the drain pump will not work.
 - If the power supply is directly connected to the L and N terminals, a communication error message may appear.
 - After completing the drainage check, turn off the unit and disconnect the power supply.
 - Reassemble the control box cover.
- b Check whether the drain pump operates correctly.
 - c Check whether the drainage is performing correctly at the end of the drain pipe.
 - d Check for leakage at the drain pipe and drain pipe connection part.
 - e When leakage occurs, check whether the fan coil unit is level and check the drain hose connection part, drainpipe connection part, and drain pump connection.
 - f When the drainage check is completed and the condensation water remains on the drain pan, remove the water.

⚠ CAUTION

- After connecting the drain pipe to the fan coil unit, be sure to perform a leak test.
Failure to do so may cause water to leak into the room, leading to property damage.
- Before servicing, first remove the condensation water from the fan coil unit drain pan.
- When pouring water on the drain pan or the hole for the drain test, be sure not to overflow.
- The leak test must be performed for at least 24 hours.

Step 10 Connecting the power and communication cables

1 Power and communication cable connection

- Before wiring work, you must turn off all power source.
- Connect the power and communication cables between the fan coil units in the electrical panel within maximum length so that the voltage drop is under 10%.
- Install an auxiliary circuit breaker (ELCB, MCCB, ELB) with sufficient capacity by considering the number of fan coil units to be connected to it.
- Connect F3 and F4 of the fan coil unit terminal block to the communication cable of the wired remote control.
- Tighten the electric wires with a proper tool within the torque limit to connect and fix them firmly, and then organize the wires to prevent outside pressure being exerted on the covers and other parts.
Failure to do so may result in overheating, electric shock, and fire.
- To protect the product from water and possible shock, you should keep the power and the communication cables in an iron pipe.
- Connect the power cable to the auxiliary circuit breaker (ELCB, MCCB, ELB).
- Keep a distance of 50 mm or more mm between the power cable and the communication cable.

Torque limit (N•m)	
M3	0.5-0.75
M3.5	0.8-1.2
M4	1.2-1.8

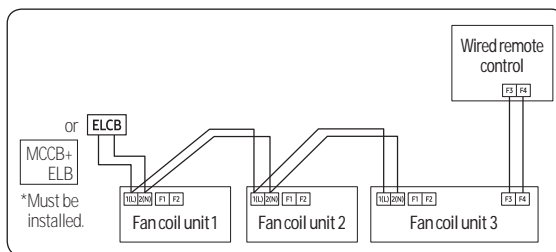

⚠ CAUTION

- The circuit diagram given above shows only wiring schematic, and the details of the actual installation are not presented.
- The standard specification is that the power supply for the fan coil unit should be separate from that for a heat source such as a chiller.
- Never branch the terminal block power supply cable from one fan coil unit to two fan coil units.
- When peeling the power cable, use a special tool for it to prevent damage to the inner sheaths.
- Make sure that more than 20 mm of the outer sheaths of the fan coil unit's power and communication cables are inserted inside the electrical part.
- Separate each communication cable from the power cable and other communication cables.
- When wiring, make sure that the connecting wire is loosened properly.

Installation Procedure

2 Selecting the crimping terminal lug

- Select the crimping terminal lug based on the nominal cross-sectional size of the power cable.
- Cover the connection part of the power cable and the crimping terminal lug to insulate it.

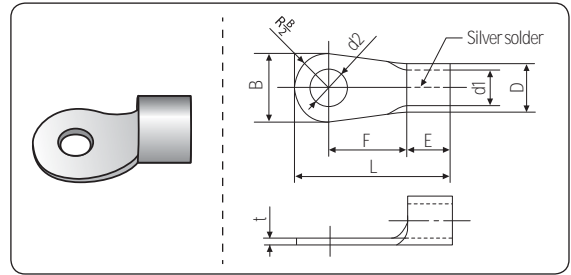

Nominal cross-sectional size	Nominal diameter of thread	B		D		d1		E	F	L	d2		t
		Basic size	Tolerance	Basic size	Tolerance	Basic size	Tolerance	Min.	Min.	Max.	Basic size	Tolerance	Min.
1.5	4	6.6	±0.2	3.4	+0.3 -0.2	1.7	±0.2	4.1	6	16	4.3	+0.2 0	0.7
	4	8											
2.5	4	6.6	±0.2	4.2	+0.3 -0.2	2.3	±0.2	6	6	17.5	4.3	+0.2 0	0.8
	4	8.5											
4	4	9.5	±0.2	5.6	+0.3 -0.2	3.4	±0.2	6	5	20	4.3	+0.2 0	0.9

3 Specifications of the terminal blocks

(Unit: mm)

AC power: M4 screw	Communication: M3 screw	Communication: M3.5 screw ELB

⚠ CAUTION

- When installing the product, be sure to install a 2-way electric valve on the water inlet pipe.
When connecting a 2-way electric valve, be sure to check the correct sub PBA terminals as shown in the figure below.
Incorrect terminal connection may cause product malfunction. (Valve: Purchased at site)
 - Specification: AC 220 to 240V (Operating current must be 0.3A or less.)
 - Applicable type: ON / OFF startup contact
- The standard specification is that the power supply for the fan coil unit should be separate from that for a heat source such as a chiller.

Wiring diagram when connecting a 2-way valve

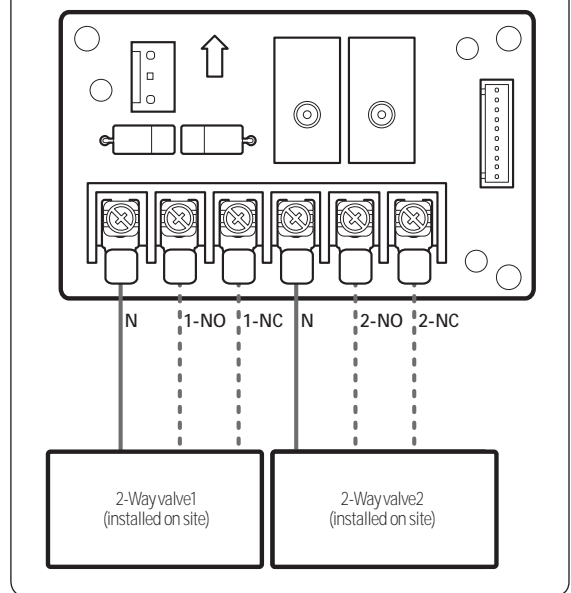

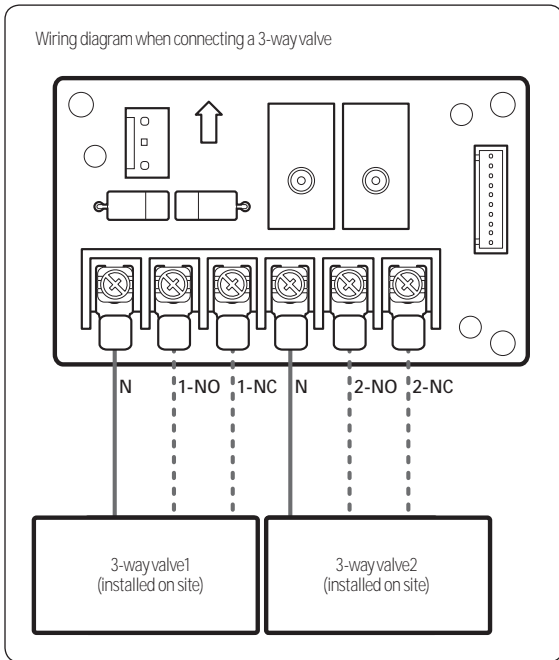

- In the 05 series installation options, the SEG15 and SEG22 values define the valve signals, classified as shown in the table below.
- SEG15 and SEG22 are set to 0 by default. After delivery, connect N, NO, and NC terminals depending on the valve specifications noting the table below:

		Valve specification	
		Normal Close	Normal Open
PBA terminal	N	Connect	Connect
	NO	Connect	Do not connect
	NC	Do not connect	Connect

- Depending on the 05 series installation options (SEG15 and SEG22), the contact output signals are as follows:

			SEG22: 0 (Cooling/Heating synchronizing signal)						SEG22: 1 (Cooling/Heating signal separated)					
			SEG15: 0			SEG15: 1			SEG15: 0			SEG15: 1		
Valve	Common terminal	Optional terminal	Cooling T-ON	Heating T-ON	Operation OFF	Cooling T-ON	Heating T-ON	Operation OFF	Cooling T-ON	Heating T-ON	Operation OFF	Cooling T-ON	Heating T-ON	Operation OFF
Valve1	N	NO	ON	ON	OFF	OFF	OFF	ON	ON	OFF	OFF	OFF	ON	ON
		NC	OFF	OFF	ON	ON	ON	OFF	OFF	ON	ON	ON	OFF	OFF
Valve2	N	NO	ON	ON	OFF	OFF	OFF	ON	ON	OFF	OFF	OFF	ON	ON
		NC	OFF	OFF	ON	ON	ON	OFF	OFF	ON	ON	ON	OFF	OFF

※ ON (220 VAC), OFF (0 VAC)

- The terminal output upon T-OFF is subject to change depending on the 05 series installation options, SEG16.

4 Specifications of electrical wiring between fan coil units

Power supply (single phase)	MCCB	ELB	Power cable	Earth wire	Communication cable
220 to 240 V Min. 198V Max. 264V	XA	XA, 30 mA 0.1 s	2.5 mm ² or more	2.5 mm ²	0.75 to 1.5 mm ²

Installation Procedure

- Decide the capacity of ELB and MCCB using the following formula.

$$X [A] = 1.25 \times 1.1 \times \sum A_i$$

NOTE

- X: The capacity of ELB, MCCB
- $\sum A_i$: Sum of the rated currents of the fan coil units

Rated currents

Mode	Rated current (A)
AG026TN1DKH*	0.14
AG032TN1DKH*	0.19
AG042TN1DKH*	0.29

- Select the cable thickness and wiring length so that the total voltage drop between the fan coil units is less than about 10% of the input voltage (220 V).

$$\sum_{k=1}^n \left(\frac{\text{Coef} \times 35.6 \times L_k}{1000 \times A_k} \times i_k \right) < 10 \% \text{ of input voltage [V]}$$

※ Coef: Approximately 1.55 in consideration of the contact resistance when the wire is fastened to the terminal

※ L_k : Distance between fan coil units [m],
 A_k : Thickness of the power cable [mm²]
 i_k : Current between fan coil units [A]

Installation example

Total power cable length $L = 100$ [m], initial pull-in current $i = 10$ [A], running current of each unit = 1 [A], total 10 fan coil units are installed.

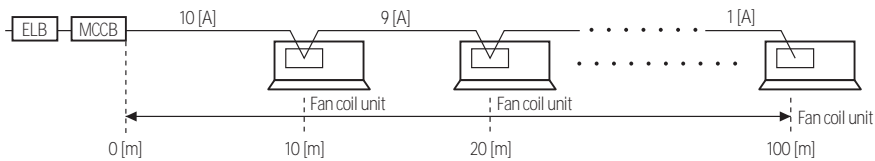

- Apply the following formula.

$$\sum_{k=1}^n \left(\frac{\text{Coef} \times 35.6 \times L_k}{1000 \times A_k} \times i_k \right) < 10 \% \text{ of input voltage [V]}$$

- Calculation

Installing with one type of wire

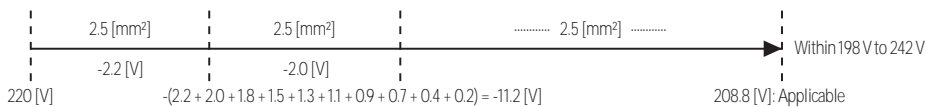



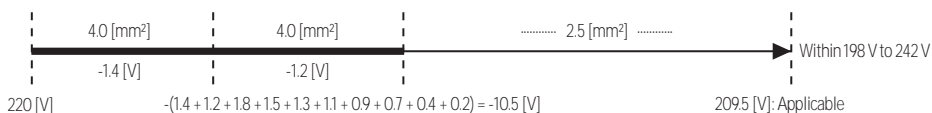

Installing with two types of wires



Step 11 Optional: Extending the power cable

1 Prepare the following tools.

Tools	Spec	Shape
Crimping pliers	MH-14	
Connection sleeve (mm)	20xØ6.5 (HxOD)	
Insulation tape	Width 19 mm	
Contraction tube (mm)	70xØ8.0 (LxOD)	

2 As shown in the figure, peel off the shields from the rubber and wire of the power cable.

- Peel off 20 mm of cable shields from the pre-installed tube.

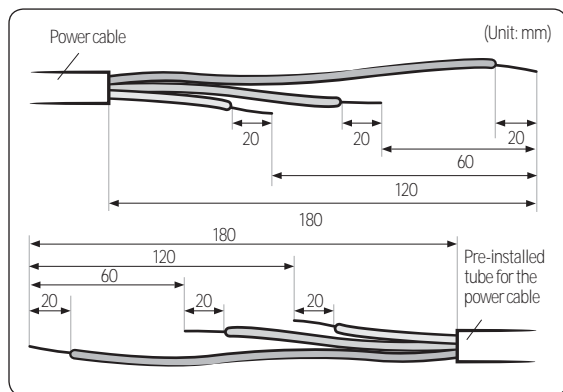

⚠ CAUTION

- For information about the power cable specifications for indoor and outdoor units, refer to the installation manual.
- After peeling off cable wires from the pre-installed tube, insert a contraction tube.

3 Insert both sides of core wire of the power cable into the connection sleeve.

- **Method 1:** Push the core wire into the sleeve from both sides.
- **Method 2:** Twist the wire cores together and push it into the sleeve.

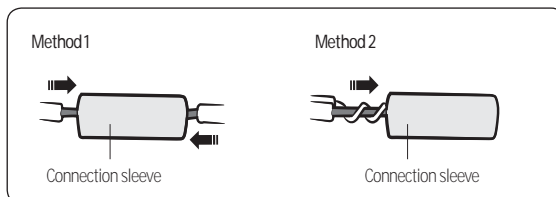

⚠ CAUTION

- If cable wires are connected without using connecting sleeves, their contact area becomes reduced, or corrosion develops on the outer surfaces of the wires (copper wires) over a long time. This may cause an increase of resistance (reduction of passing current) and consequently may result in a fire.

4 Using a crimping tool, compress the two points and flip it over and compress another two points in the same location.

- The compression dimension should be 8.0.

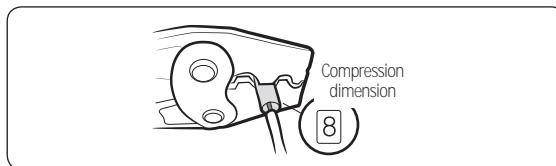

- After compressing it, pull both sides of the wire to make sure it is firmly pressed.

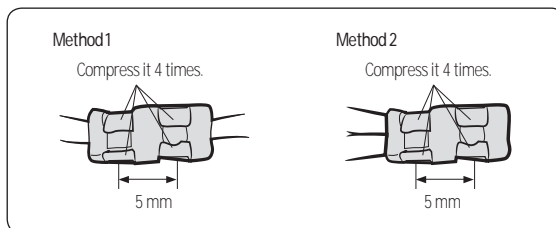

Installation Procedure

- 5 Wrap it with the insulation tape twice or more and position your contraction tube in the middle of the insulation tape.

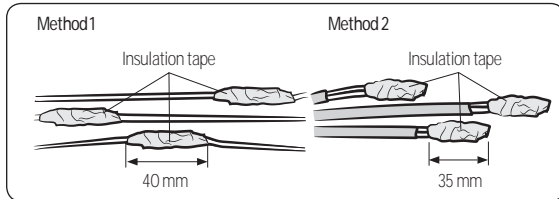

- 6 Apply heat to the contraction tube to contract it.

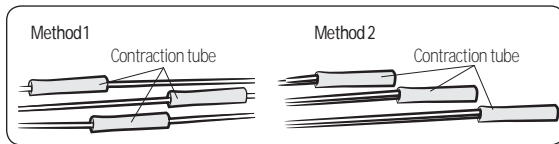

- 7 After tube contraction work is completed, wrap it with the insulation tape to finish. Three or more layers of insulation are required.

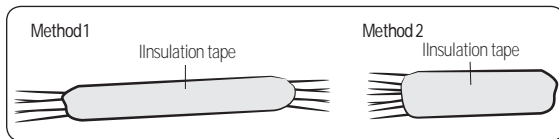

CAUTION

- Make sure that the connection parts are not exposed to outside.
- Be sure to use insulation tape and a contraction tube made of approved reinforced insulating materials that have the same level of withstand voltage with the power cable. (Comply with the local regulations on extensions.)

WARNING

- In case of extending the electric wire, please DO NOT use a round-shaped Pressing socket.
 - Incomplete wire connections can cause electric shock or a fire.

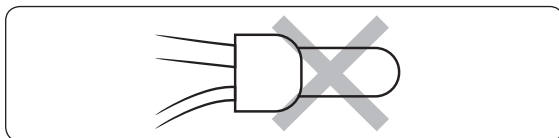

Step 12 Setting the fan coil unit addresses and installation options

The fan coil unit address setting and installation options are set with the remote control option.

You cannot set both of the fan coil unit addresses and the installation options in a batch: set both of them respectively.

If you need to set the fan coil unit address and the installation options, you must perform the setting work twice.

Common steps for setting the addresses and options

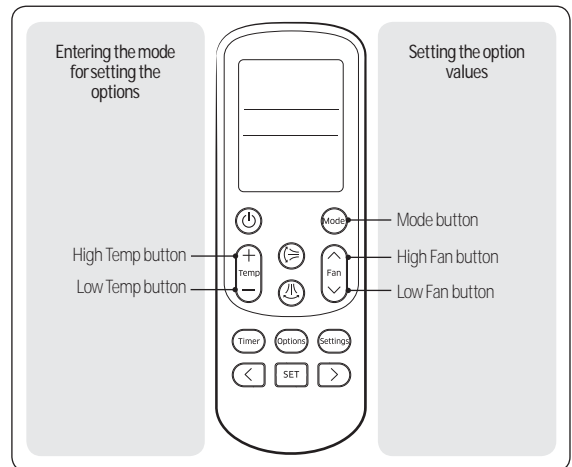

- 1 Enter the mode for setting the options:
 - a Remove the batteries from the remote control, and then insert them again.
 - b While holding down the (High Temp) and (Low Temp) buttons simultaneously, insert the batteries into the remote control.
 - c Make sure that you are entered to the mode for setting the options:

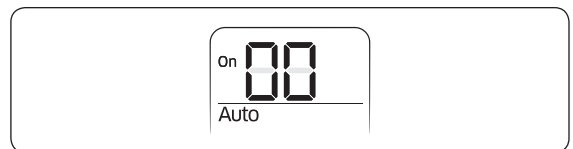

2 Set the option values.

CAUTION

- The total number of available options are 24: SEG1 to SEG24.
- Because SEG1, SEG7, SEG13, and SEG19 are the page options used by the previous remote control models, the modes to set values for these options are skipped automatically.
- Set a 2-digit value for each option pair in the following order: SEG2 and SEG3 → SEG4 and SEG5 → SEG6 and SEG8 → SEG9 and SEG10 → SEG11 and SEG12 → SEG14 and SEG15 → SEG16 and SEG17 → SEG18 and SEG20 → SEG21 and SEG22 → SEG23 and SEG24.





















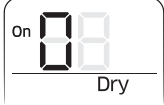
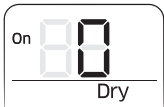











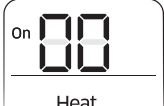

SEG1	SEG2	SEG3	SEG4	SEG5	SEG6
0	X	X	X	X	X
SEG7	SEG8	SEG9	SEG10	SEG11	SEG12
1	X	X	X	X	X
SEG13	SEG14	SEG15	SEG16	SEG17	SEG18
2	X	X	X	X	X
SEG19	SEG20	SEG21	SEG22	SEG23	SEG24
3	X	X	X	X	X







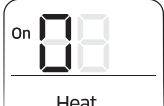









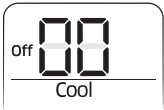

On (SEG1 to SEG12)	Off (SEG13 to SEG24)

Take the steps presented in the following table:

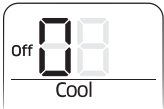
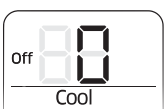





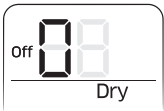
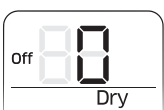



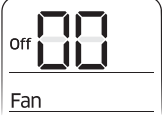





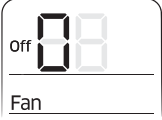

Steps	Remote control display
<p>1 Set the SEG2 and SEG3 values:</p> <p>a Set the SEG2 value by pressing the (Low Fan) button repeatedly until the value you want to set appears on the remote control display.</p> <p>b Set the SEG3 value by pressing the (High Fan) button repeatedly until the value you want to set appears on the remote control display.</p> <p>When you press the (Low Fan) or (High Fan) button, values appear in the following order: 0 → 1 → ... E → F</p>	 SEG2 SEG3
<p>2 Press the (Mode) button. Cool and On appear on the remote control display.</p>	
<p>3 Set the SEG4 and SEG5 values:</p> <p>a Set the SEG4 value by pressing the (Low Fan) button repeatedly until the value you want to set appears on the remote control display.</p> <p>b Set the SEG5 value by pressing the (High Fan) button repeatedly until the value you want to set appears on the remote control display.</p> <p>When you press the (Low Fan) or (High Fan) button, values appear in the following order: 0 → 1 → ... E → F</p>	 SEG4 SEG5

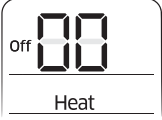
Installation Procedure

Steps	Remote control display
<p>4 Press the  (Mode) button. Dry and On appear on the remote control display.</p>	
<p>5 Set the SEG6 and SEG8 values:</p> <p>a Set the SEG6 value by pressing the  (Low Fan) button repeatedly until the value you want to set appears on the remote control display.</p> <p>b Set the SEG8 value by pressing the  (High Fan) button repeatedly until the value you want to set appears on the remote control display.</p> <p>When you press the  (Low Fan) or  (High Fan) button, values appear in the following order:  →  → ... →  → </p>	 
<p>6 Press the  (Mode) button. Fan and On appear on the remote control display.</p>	
<p>7 Set the SEG9 and SEG10 values:</p> <p>a Set the SEG9 value by pressing the  (Low Fan) button repeatedly until the value you want to set appears on the remote control display.</p> <p>b Set the SEG10 value by pressing the  (High Fan) button repeatedly until the value you want to set appears on the remote control display.</p> <p>When you press the  (Low Fan) or  (High Fan) button, values appear in the following order:  →  → ... →  → </p>	 
<p>8 Press the  (Mode) button. Heat and On appear on the remote control display.</p>	
<p>9 Set the SEG11 and SEG12 values:</p> <p>a Set the SEG11 value by pressing the  (Low Fan) button repeatedly until the value you want to set appears on the remote control display.</p> <p>b Set the SEG12 value by pressing the  (High Fan) button repeatedly until the value you want to set appears on the remote control display.</p> <p>When you press the  (Low Fan) or  (High Fan) button, values appear in the following order:  →  → ... →  → </p>	 

Steps	Remote control display
<p>10 Press the  (Mode) button. Auto and Off appear on the remote control display.</p>	
<p>11 Set the SEG14 and SEG15 values:</p> <p>a Set the SEG14 value by pressing the  (Low Fan) button repeatedly until the value you want to set appears on the remote control display.</p> <p>b Set the SEG15 value by pressing the  (High Fan) button repeatedly until the value you want to set appears on the remote control display.</p> <p>When you press the  (Low Fan) or  (High Fan) button, values appear in the following order: 0 → 1 → ... E → F</p>	 <p style="text-align: center;">SEG14</p>  <p style="text-align: center;">SEG15</p>
<p>12 Press the  (Mode) button. Cool and Off appear on the remote control display.</p>	
<p>13 Set the SEG16 and SEG17 values:</p> <p>a Set the SEG16 value by pressing the  (Low Fan) button repeatedly until the value you want to set appears on the remote control display.</p> <p>b Set the SEG17 value by pressing the  (High Fan) button repeatedly until the value you want to set appears on the remote control display.</p> <p>When you press the  (Low Fan) or  (High Fan) button, values appear in the following order: 0 → 1 → ... E → F</p>	 <p style="text-align: center;">SEG16</p>  <p style="text-align: center;">SEG17</p>
<p>14 Press the  (Mode) button. Dry and Off appear on the remote control display.</p>	
<p>15 Set the SEG18 and SEG20 values:</p> <p>a Set the SEG18 value by pressing the  (Low Fan) button repeatedly until the value you want to set appears on the remote control display.</p> <p>b Set the SEG20 value by pressing the  (High Fan) button repeatedly until the value you want to set appears on the remote control display.</p> <p>When you press the  (Low Fan) or  (High Fan) button, values appear in the following order: 0 → 1 → ... E → F</p>	 <p style="text-align: center;">SEG18</p>  <p style="text-align: center;">SEG20</p>

Installation Procedure

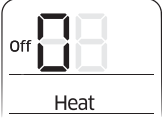
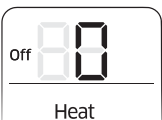
Steps	Remote control display
<p>16 Press the  (Mode) button. Fan and Off appear on the remote control display.</p>	
<p>17 Set the SEG21 and SEG22 values:</p> <p>a Set the SEG21 value by pressing the  (Low Fan) button repeatedly until the value you want to set appears on the remote control display.</p> <p>b Set the SEG22 value by pressing the  (High Fan) button repeatedly until the value you want to set appears on the remote control display.</p> <p>When you press the  (Low Fan) or  (High Fan) button, values appear in the following order:  →  → ... →  → </p>	 <p style="text-align: center;">SEG21</p>  <p style="text-align: center;">SEG22</p>
<p>18 Press the  (Mode) button. Heat and Off appear on the remote control display.</p>	
<p>19 Set the SEG23 and SEG24 values:</p> <p>a Set the SEG23 value by pressing the  (Low Fan) button repeatedly until the value you want to set appears on the remote control display.</p> <p>b Set the SEG24 value by pressing the  (High Fan) button repeatedly until the value you want to set appears on the remote control display.</p> <p>When you press the  (Low Fan) or  (High Fan) button, values appear in the following order:  →  → ... →  → </p>	 <p style="text-align: center;">SEG23</p>  <p style="text-align: center;">SEG24</p>

Setting the fan coil unit installation option (suitable for the condition of each installation location)

- 1 Make sure that the power is supplied to the fan coil unit.
 - If the fan coil unit is not plugged in, it must include a power supply.

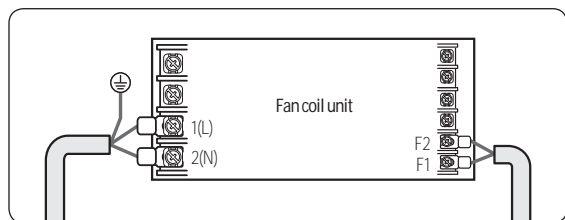

- 2 Make sure that the panel or display is connected to the fan coil unit so that it can receive options
- 3 Set an address for each fan coil unit using the remote control, according to your air conditioning system plan.
 - The fan coil unit addresses are set to 020010-100001-200000-300000 by default.
 - The SEG20 option, individual control with remote control, allows you to control multiple fan coil units individually by using the remote control.
- 4 Set the fan coil unit installation options using the remote control.

Installation options for the O2 series

SEG1	SEG2	SEG3	SEG4	SEG5	SEG6
0	2	-	Use of external temperature sensor / Minimizing fan operation when thermostat is off	Use of central control	-
SEG7	SEG8	SEG9	SEG10	SEG11	SEG12
1	Use of drain pump	Use of hot water heater	-	-	Dew removal operation in Wind-Free mode / Auto Evaporator Drying fan mode / Auto fan smart comfortable mode
SEG13	SEG14	SEG15	SEG16	SEG17	SEG18
2	Use of external control	External control output / External heater output / Cooling operation output / Cooling output by external equipment	S-Plasma ion	Buzzer control	Maximum filter usage time
SEG19	SEG20	SEG21	SEG22	SEG23	SEG24
3	Individual control with remote control	Heating setting compensation	-	-	-

- Slim 1 way
 - Even if you set the Use of drain pump (SEG8) option to 0, it is automatically set to "Use + 3 minute delay."
 - If you set the Maximum filter usage time (SEG18) option to a value other than 2 and 6, it is automatically set to 2 (1000 hours).
- If you set an option to a value that is out of range specified above, the option is automatically set to 0 by default.
- The SEG5 option (Use of central control) is set to 1 (Use) by default. Therefore, you don't need to set the SEG5 option additionally. Note that even if the central control system is not connected, no errors occur. If you want a specific fan coil unit not to be controlled by the central control system, set the SEG option of that fan coil unit to 0 (Disuse).
- The external heater output of SEG15 is generated via MIM-B14 connection. (Refer to the manual of AIM-B14)

Installation Procedure

Installation options for the O2 series (detailed)

Option No.: 02XXXX-1XXXXX-2XXXXX-3XXXXX

Option	SEG1		SEG2		SEG3		SEG4			SEG5		SEG6	
Function	Page		Mode		-		Use of external temperature sensor / Minimizing fan operation when thermostat is off			Use of central control		Compensation of the fan RPM	
Indications and details	Indication	Detail	Indication	Detail	Indication	Detail	Indication	Detail		Indication	Detail	Indication	Detail
								Use of external temperature sensor	Minimizing fan operation when thermostat is off				
							0	Disuse	Disuse	0	Disuse	0	Disuse
							1	Use	Disuse				
							2	Disuse	(Heating) Use (*1)				
							3	Use	(Heating) Use (*1)				
							4	Disuse	(Cooling) Use (*1)				
							5	Use	(Cooling) Use (*1)	1	Use	1	Compensation of the fan RPM
							6	Disuse	Use (*1)				
							7	Use	Use (*1)				
							8	Disuse	(Cooling) Lowest fan speed (*1)	1	Use	2	(4 way only) High-ceiling mode
							9	Use	(Cooling) Lowest fan speed (*1)				
							A	Disuse	(Cooling) Lowest fan speed / (Heating) Use (*1)				
						B	Use	(Cooling) Lowest fan speed / (Heating) Use (*1)					

Installation Procedure

Option	SEG7		SEG8		SEG9		SEG10	SEG11	SEG12																						
Function	Page		Use of drain pump		Use of hot water heater				Dew removal operation in Wind-Free mode / Auto Evaporator Drying fan mode / Auto fan smart comfortable mode																						
Indications and details	Indication	Detail	Indication	Detail	Indication	Detail			Indication	Dew removal operation in Wind-Free mode	Auto Evaporator Drying fan mode	Auto fan smart comfortable																			
	1			0	Disuse	0	Disuse			0 (Default)	Maintain blade status in Wind-Free mode	Use every fan mode	Use																		
				1	Use	1	Use (*2)			1	Cooling operation by opening the blade	Use every fan mode	Use																		
				2	Use with 3 minute delay	2		2				2	Maintain blade status in Wind-Free mode	Use only Wind-Free mode	Use																
								3	Use (*2)			3	Cooling operation by opening the blade	Use only Wind-Free mode	Use																
				2									4	Maintain blade status in Wind-Free mode	Use every fan mode	Disuse															
													5	Cooling operation by opening the blade	Use every fan mode	Disuse															
													6	Maintain blade status in Wind-Free mode	Use only Wind-Free mode	Disuse															
													7	Cooling operation by opening the blade	Use only Wind-Free mode	Disuse															
Option				SEG13		SEG14		SEG15				SEG16		SEG17		SEG18															
Function	Page		Use of external control		External control output / External heater output / Cooling operation output / Cooling output by external equipment				S-Plasma ion		Buzzer control		Maximum filter usage time																		
Indications and details	Indication	Detail	Indication	Detail	Indication	Detail		Indication	Detail	Indication	Detail	Indication	Detail																		
	2					Setting the output of external control	External heater On or Off signal																								
														0	Disuse	0	External control output (Thermo On)	0	Disuse	0	Use of buzzer	2	1000 hours								
														1	On/Off control	1	External control output (Operation On)														
														2	Off control	2	External heater output (* 3)														
														3	Window On or Off control									1	Use	1	Disuse of buzzer	6	2000 hours		
																														3	External heater output (* 3)
																														4	Cooling operation output (* 4)
														3																	
																														5	Cooling output by external equipment (Cooling Thermo On) (* 5)
6														Cooling output by external equipment (Cooling / Drying Thermo On) (* 5)																	

Installation Procedure

Option	SEG19		SEG20		SEG21		SEG22	SEG23	SEG24	
Function	Page		Individual control with remote control		Heating setting compensation					
Indications and details	Indication	Detail	Indication	Detail	Indication	Details	-	-	-	
	3			0 or 1	Channel 1	0				Default (*6)
				2	Channel 2	1				2 °C
				3	Channel 3	2				5 °C
				4	Channel 4					

(*1) Minimizing fan operation when thermostat is off:

- The fan operates for 20 seconds at an interval of 5 minutes in the **Heat** mode.
- When thermostat is off in the **Cool** mode, the fan stops or Ultra breeze function starts based on the setting.

(*2) 1: The fan is turned on continually when the hot water heater is turned on,

3: The fan is turned off when the hot water heater is turned on with cooling only fan coil unit.

(*3) When the following 2 or 3 is used as external heater On or Off signal, the signal for monitoring external contact control will not be output.

2: The fan is turned on continually when the external heater is turned on

3: The fan is turned off when the external heater is turned on with cooling only fan coil unit

※ If the fan is set to off for cooling only fan coil unit by setting the SEG9=3 or SEG15=3, you need to use an external sensor or wired remote control sensor to detect indoor temperature exactly.

(*4) Output occurs when operating in the **Cool** or **Dry** mode.

(*5) An Economizer controller is required to use the Cooling output by external equipment function.

(*6) Default setting : 2°C

Installation options for the O5 series

SEG1	SEG2	SEG3	SEG4	SEG5	SEG6
0	5	-	-	-	-
SEG7	SEG8	SEG9	SEG10	SEG11	SEG12
1	-	-	-	-	-
SEG13	SEG14	SEG15	SEG16	SEG17	SEG18
2	Adjustable breeze	Water valve control type	Valve control at Thermo Off	Water pipe valve is installed?	Control variable when using hot water heater or external heater
SEG19	SEG20	SEG21	SEG22	SEG23	SEG24
3	Choose whether to use Interface module	Displaying the water-temperature rise-prevention error messages	Timing separation of the cooling and heating signals for the water pipe valve	Forced air speed for cooling / heating	-

Installation options for the O5 series (detailed)

Option No.: 05XXXX-1XXXXX-2XXXXX-3XXXXX

Option	SEG1		SEG2		SEG3		SEG4		SEG5		SEG6			
Function	Page		Mode											
Indications and details	Indication	Detail	Indication	Detail			-		-		-			
	0		5											
Option	SEG7		SEG8		SEG9		SEG10		SEG11		SEG12			
Function	Page													
Indications and details	Indication	Detail	-		-		-		-		-			
	1													
Option	SEG13		SEG14		SEG15		SEG16		SEG17		SEG18			
Function	Page		Adjustable breeze		Water pipe valve type		Valve control at Thermo Off		Water pipe valve is installed?		Control variable when using hot water heater or external heater (* 1)			
Indications and details	Indication	Detail	Indication	Detail	Indication	Detail	Indication	Detail	Indication	Detail	Indication	Detail		
												Heater On offset temperature	Heater On delay time	
	2			0	0	0 (factory default)	Normal Close	0	Close	0	Installed	0	At the same time with thermo on	Immediately
				1	1							1	At the same time with thermo on	10 min.
				2	2							2	At the same time with thermo on	20 min.
				3	3							3	1.5 °C	Immediately
				4	4							4	1.5 °C	10 min.
				5	5							5	1.5 °C	20 min.
				6	6							6	3.0 °C	Immediately
				7	7							7	3.0 °C	10 min.
				8	8							8	3.0 °C	20 min.
				9	9	9	4.5 °C	Immediately						
				A	10	A	4.5 °C	10 min.						
				B	11	B	4.5 °C	20 min.						
				C	12	C	6.0 °C	Immediately						
				D	13	D	6.0 °C	10 min.						
				E	14	E	6.0 °C	20 min.						
F	NOT USED													

Installation Procedure

Option	SEG19		SEG20		SEG21		SEG22		SEG23			SEG24
Function	Page		Choose whether to use Interface module		Displaying the water temperature rise prevention messages		Timing separation of the cooling and heating signals for the water pipe valve		Forced air speed for cooling / heating			
Indications and details	Indication	Detail	Indication	Detail	Indication	Detail	Indication	Detail	Indication	Detail		
	3		0	Use (default)	0	Use (* 3)	0	The cooling and heating signals are sent simultaneously.	0	Air speed for cooling	Air speed for heating	
									0	Disuse	Disuse	
									1	Disuse	Use (User sets the air speed.)	
									2	Disuse	Use (High speed)	
									3	Disuse	Use (High speed)	
									4	Use (User sets the air speed.)	Disuse	
									5	Use (User sets the air speed.)	Use (User sets the air speed.)	
									6	Use (User sets the air speed.)	Use (High speed)	
									7	Use (User sets the air speed.)	Use (High speed)	
									8	Use (High speed)	Disuse	
									9	Use (High speed)	Use (User sets the air speed.)	
									A	Use (High speed)	Use (High speed)	
									B	Use (High speed)	Use (High speed)	
									C	Use (High speed)	Disuse	
			1	Disuse (Group control using remote control) (* 2)	1	Disuse (* 4)	1	The cooling and heating signals are sent separately.	D	Use (High speed)	Use (User sets the air speed.)	
									E	Use (High speed)	Use (High speed)	
									F	Use (High speed)	Use (High speed)	

(*1) Heater operation when the O2 series installation option SEG9 "Use of hot water heater" is set to 'Use' or the O2 series installation option SEG15 "External heater On or Off signal" is set to 'Use'

Example 1) When the O2 series SEG9 is set to '1' and the O5 series SEG8 is set to '0':

When the heating thermostat turns on, the hot water heater turns on immediately. When the heating thermostat turns off, the hot water heater turns off immediately.

Example 2) When the O2 series SEG15 is set to '2' and the O5 series SEG8 is set to 'A':

If the state "room temperature \leq set temperature + f(heating compensation temperature) - 4.5 °C" continues for 10 minutes, the external heater turns on.

If the state "room temperature $>$ set temperature + f(heating compensation temperature) - 4.5 °C + 1 °C" is reached, the external heater turns off. (Where, 1 °C is the hysteresis to determine heater on or off.)

- (*2) An FCU relay (MIM-F10N) must be installed in order to connect with the host controller and the wired remote control. Set this option to '1' if an FCU is installed alone without connecting to a host controller.
Set this option to '1' if multiple FCUs (up to 16) are installed and connected to one wired remote control.
- (*3) If the air conditioner is operated for more than 1 hour under the conditions that the heating fan is on and $[(\text{Eva in} + \text{Eva out}) / 2] > 65 \text{ }^\circ\text{C}$, E128 occurs.
- (*4) E128 is skipped.

5 Check whether the option values that you have set are correct by pressing the Operation or Mode button repeatedly.

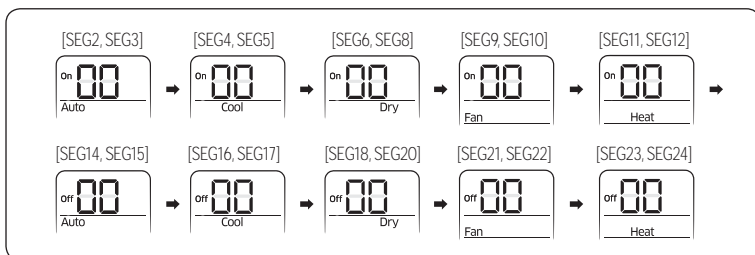

- 6 Save the option values into the fan coil unit:
- Point the remote control to the remote control sensor on the fan coil unit and then press the ⏻ (Power) button on the remote control twice.
Make sure that this command is received by the fan coil unit. When it is successfully received, you can hear a short sound from the fan coil unit. If the command is not received, press the ⏻ (Power) button again.
- 7 Check whether the fan coil unit operates in accordance with the option values you have set:
- Reset the fan coil unit by disconnecting and then reconnecting the power cable of the fan coil unit or by pressing the RESET button on the outdoor unit.
 - Remove the batteries from the remote control, insert them again, and then press the ⏻ (Power) button on the remote control.

Setting the fan coil unit address (main / RMC)

- 1 Make sure that the power is supplied to the fan coil unit.
- If the fan coil unit is not plugged in, it must include a power supply.

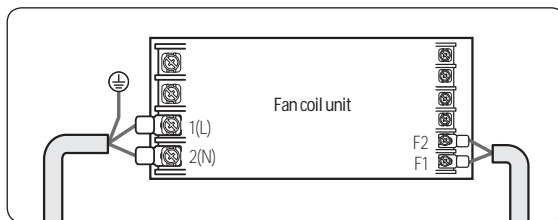

- 2 Make sure that the panel or display is connected to the fan coil unit so that it can receive options
- 3 Set an address (main or RMC address) for each fan coil unit using the remote control, according to your air conditioning system plan.
- 4 The fan coil unit addresses (main and RMC addresses) are set to 0A0000-100000-200000-300000 by default.

Installation Procedure

Changing the addresses and options individually

When you want to change the value of a specific option, refer to the following table and follow the steps in "Common steps for setting the addresses and options."

Option	SEG1		SEG2		SEG3		SEG4		SEG5		SEG6	
Function	Page		Mode		Type of the option to change		Tens digit of the option number		Units digit of the option number		New value	
Indications and details	Indication	Detail	Indication	Detail	Indication	Detail	Indication	Detail	Indication	Detail	Indication	Detail
		0		D		Option type	1 to 6	Tens digit value	0 to 9	Units digit value	0 to 9	New value

NOTE

- To change the value of a position of the fan coil unit address, set SEG3 to A.
- To change the value of a position of the fan coil unit installation options, set SEG3 to 2.
Example) Changing the Buzzer control (SEG17) option of the installation options to 1 (disuse).

Option	SEG1	SEG2	SEG3	SEG4	SEG5	SEG6
Function	Page	Mode	Option mode to change	Tens digit of the option number	Units digit of the option number	New value
Indication	0	D	2	1	7	1

Step 13 Performing the test operation

- Before turning on the product, measure resistances between the power terminals (single phase: L, N) and the earthing of the fan coil unit using a DC 500V insulation resistance meter.
 - The measured values must be at least 30 MΩ.

⚠ CAUTION

- Never measure resistance for the communication terminal. Failure to do so may damage the communication circuit.
 - Use a general circuit tester to check the communication terminal for short circuit.
- Before turning on the product, check the voltage of the power source (L, N).

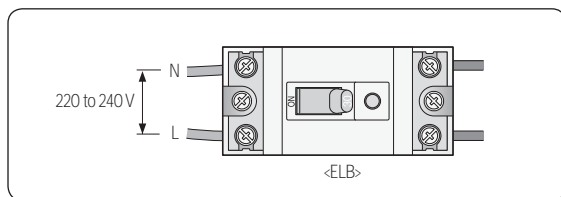

- After completing the installation, check the following to ensure that the fan coil unit operates normally:
 - Strength of the installation site
 - Water leakage
 - Power and electric wiring connections
 - Heat-resistant insulation of the pipes
 - Drainage
 - Connections to the auxiliary circuit breaker, earthing status
 - Normal operation in each operation mode
- After finishing the test run, refer to the user manual and explain the following to the customer:
 - Starting and stopping the fan coil unit
 - Using the operation modes and the functions
 - Cleaning the fan coil unit and replacing the filter

⚠ CAUTION

- For the test run, be sure to operate each fan coil unit separately to secure S-NET data.
- After installation, test run, and delivery, tell the user to store the user manual and this installation manual in a safe place.

⚠ CAUTION

Operating precautions

- Be sure to operate heat sources (chiller, boiler) after starting the fan coil unit.
- Be sure to stop the fan coil unit after stopping heat sources (chiller, boiler).
- When heat sources (chiller, boiler) are not used for more than 4 hours in Cool mode, stop the water circulation.
- If the water circulation cannot be stopped, operate the fan at low speed.
 - If cold water flows while the fan of the fan coil unit is stopped, condensation may develop on the fan coil unit (main unit, motor, grill, etc.), shortening the product life.
- Do not use the product in hot and humid places (relative humidity 80% or more).
 - Water falling from the product may cause fire or property damage.
- In winter, operate the water pump continuously for water circulation.
- When a season ends or when the product is not used for a long time, completely drain water from the entire system.
 - Failure to do so may cause the pipes to freeze and burst, leading to property damage.

Appendix





Troubleshooting

The following error indications appear on the fan coil unit display when a problem occurs.

Error detection and restart

- If an error occurs during operation, the display blinks to indicate an error and all operations except for the display operation stop.
- When you restart the product using the remote control and the switch, a normal operation starts, and then the detected error mode is determined.

Display indications at error detection

Condition of the fan coil unit	Error code	Fan coil unit display indications				
						
		Slim 1 way cassette				
		Blue	Yellow green			
Short- or open-circuit error of the room temperature sensor	E121	X	●	●	X	X
1. Short- or open-circuit error of the EVA IN sensor	E122	●	X	●	X	X
2. Short- or open-circuit error of the EVA OUT sensor	E123					
Error of the fan	E154		X		●	X
1. Error that there is no communication between FCU relays for 2 minutes	E101					
2. Communication error received from the relay	E102					
3. Error that relay tracking continued for 3 minutes	E202					
4. Communication error that the actual number of installed FCUs differs from the number detected by tracking	E201	X	X	●	●	X
5. Error due to duplicated communication addresses	E108					
6. Error that communication addresses are not yet determined	E109					
Communication errors other than the errors listed above						
Errors detected by the self-diagnosis						
1. Error of water temperature rise prevention ※ The product stops at high water temperature above 65 °C.	E128	X	X	●	●	●
2. Thermal fuse open error	E198					
Second detection of the float switch error	E153	X	X	X	●	●
EEPROM error	E162	●	●	●	●	●
EEPROM option error	E163	●	●	●	●	●

● : Blinking X : Off

NOTE

- If you stop the operation while an error is being indicated, all the indicators are turned off.
- In case of re-operation, a normal operation starts, and then the product reevaluates the detected error and displays it again if required.
- If the E108 error occurs, set the FCU address again, and then reset the system.
Example) If the fan coil units 1 and 2 are set to the address 5, the fan coil unit 1 is changed from 1 to 5, and E108 and A002 are displayed on the fan coil unit 2.

Memo

Memo

