

Fan Coil Unit

User manual

AG***N1DEH* / AG***N4DKH* / AG***N4PKH*

- Thank you for purchasing this Samsung fan coil unit.
- Before operating this unit, please read this user manual carefully and retain it for future reference.



SAMSUNG

Contents

Safety Information	3
Safety Information	3
At a Glance	11
Fan Coil Unit Overview	11
Operation Features	14
Operating temperature and humidity	14
Cleaning and Maintenance	15
Cleaning and Maintaining	15
Cleaning the fan coil unit	15
Cleaning the air filter	16
Periodical maintenance	26
Troubleshooting	27
Technical specifications	30



***Correct Disposal of This Product
(Waste Electrical & Electronic Equipment)***

(Applicable in countries with separate collection systems)

This marking on the product, accessories or literature indicates that the product and its electronic accessories (e.g. charger, headset, USB cable) should not be disposed of with other household waste at the end of their working life. To prevent possible harm to the environment or human health from uncontrolled waste disposal, please separate these items from other types of waste and recycle them responsibly to promote the sustainable reuse of material resources. Household users should contact either the retailer where they purchased this product, or their local government office, for details of where and how they can take these items for environmentally safe recycling.

Business users should contact their supplier and check the terms and conditions of the purchase contract. This product and its electronic accessories should not be mixed with other commercial wastes for disposal.

For information on Samsung's environmental commitments and product-specific regulatory obligations, e.g. REACH, WEEE, Batteries, visit: www.samsung.com/uk/aboutsamsung/sustainability/environment/our-commitment/data/

Safety Information

Before using your new fan coil unit, please read this manual thoroughly to ensure that you know how to safely and efficiently operate the extensive features and functions of your new appliance.





Because the following operating instructions cover various models, the characteristics of your fan coil unit may differ slightly from those described in this manual. If you have any questions, call your nearest contact centre or find help and information online at www.samsung.com.

WARNING

Hazards or unsafe practices that may result in severe personal injury or death.

CAUTION

Hazards or unsafe practices that may result in minor personal injury or property damage.

-  Follow directions.
-  Do NOT attempt.
-  Make sure the machine is grounded to prevent electric shock.
-  Cut-off the power supply.
-  Do NOT disassemble.

FOR INSTALLATION

WARNING

-  **Use the power line with the power specifications of the product or higher and use the power line for this appliance only. In addition, do not use an extension line.**
 - Extending the power line may result in electric shock or fire.
 - Do not use an electric transformer. This may result in electric shock or fire.
 - If the voltage/frequency/rated current condition is different, it may cause fire.

Safety Information

! The installation of this appliance must be performed by a qualified technician or service company.

- Failing to do so may result in electric shock, fire, explosion, problems with the product, or injury and may also void warranty on the installed product.

Install a Isolation Switch next to the Fan Coil Unit (but not on the panels of the Fan Coil Unit)and circuit breaker dedicated to the fan coil unit.

- Failing to do so may result in electric shock or fire.

⊘ Do not install this appliance near a heater, inflammable material. Do not install this appliance in a humid, oily or dusty location, in a location exposed to direct sunlight and water (rain drops). Do not install this appliance in a location where gas may leak.

- This may result in electric shock or fire.

⚡ This appliance must be properly grounded. Do not ground the appliance to a gas pipe, plastic water pipe, or telephone line.

- Failure to do so may result in electric shock, fire, an explosion, or other problems with the product.
- Never plug the power cord into a socket that is not grounded correctly and make sure that it is in accordance with local and national codes.

⚠ CAUTION

! Install your appliance on a level and hard floor that can support its weight.

- Failing to do so may result in abnormal vibrations, noise, or problems with the product.

When installing the product, make sure to install the draining hose properly, so that water is drained correctly.

- Failing to do so may result in water overflowing and property damage.

! **If using the product after being left idle for an extended period of time, make sure to open the air vent valve to release air.**

- Running water noises may occur inside, or cooling/heating performance may degrade.
- Use a bucket or hose to catch water. If using Cool mode only, in the winter season, make sure to remove stagnant water to prevent the product from freezing and bursting. After drainage, lock the valve securely.

To turn on the product, start the fan coil unit first and then start the heat source device, e.g. chiller or boiler.

To turn off the product, stop the heat source device, e.g. chiller or boiler, first and then stop the fan coil unit.

If the heat source device, e.g. chiller or boiler, will not be used for more than four hours when in Cool mode, stop water circulation.

If it is impossible to stop water circulation, decrease the fan speed.

- If cold water runs when the fan of the fan coil unit is off, condensation may occur on the fan coil unit components, such as the main unit, motor or grille, and affect the lifespan of the product.

Do not use the product in a hot and humid location with relative humidity over 80%.

- There is risk of fire and property loss due to water dripping from the product.

When using the product in the winter, continuously operate the water pump to circulate water.



If the product will not be used for long periods of time, completely drain the system.

- The product may freeze and burst, resulting in property loss.

Safety Information

FOR POWER SUPPLY

WARNING

-  When the circuit breaker is damaged, contact your nearest service centre.
-  Do not pull or excessively bend the power line. Do not twist or tie the power line. Do not hook the power line over a metal object, place a heavy object on the power line, insert the power line between objects, or push the power line into the space behind the appliance.
 - This may result in electric shock or fire.

CAUTION

-  When not using the fan coil unit for a long period of time or during a thunder/lightning storm, cut the power at the circuit breaker.
 - Failing to do so may result in electric shock or fire.

Cut off the power to the valve before cutting off the power to the product.

- Power is consumed if the power supply is connected.
- Install an electric two-way valve at the inlet of the fan coil unit. If a valve is not installed, cold and hot water circulation continues. Water flooding may occur due to condensation water. Either keep supplying power to enable drainage, or check that cold water is not supplied.

FOR USING

WARNING

If the appliance is flooded, please contact your nearest service centre.

- Failing to do so may result in electric shock or fire.

If the appliance generates a strange noise, a burning smell or smoke, unplug the power plug immediately and contact your nearest service centre.

- Failing to do so may result in electric shock or fire.

In the event of a gas leak (such as propane gas, LP gas, etc.), ventilate immediately without touching the power line. Do not touch the appliance or power line.

- Do not use a ventilating fan.
- A spark may result in an explosion or fire.

To reinstall the fan coil unit, please contact your nearest service centre.

- Failing to do so may result in problems with the product, water leakage, electric shock, or fire.
- A delivery service for the product is not provided. If you reinstall the product in another location, additional construction expenses and an installation fee will be charged.
- Especially, when you wish to install the product in an unusual location such as in an industrial area or near the seaside where it is exposed to salt in the air, please contact your nearest service centre.

Do not touch the circuit breaker with wet hands.

- This may result in electric shock.

Do not turn the fan coil unit off with the circuit breaker while it is operating.

- Turning the fan coil unit off and then on again with the circuit breaker may cause a spark and result in electric shock or fire.

Safety Information

- ⊘ After unpacking the fan coil unit, keep all packaging materials well out of the reach of children, as packaging materials can be dangerous to children.**
- If a child places a bag over its head, it may result in suffocation.
- Do not touch the front panel with your hands or fingers during the heating operation.**
- This may result in electric shock or burns.
- Do not insert your fingers or foreign substances into the outlet when the fan coil unit is operating or the front panel is closing.**
- Take special care that children do not injure themselves by inserting their fingers into the product.
- Do not insert your fingers or foreign substances into the air inlet/outlet of the fan coil unit.**
- Take special care that children do not injure themselves by inserting their fingers into the product.
- Do not strike or pull the fan coil unit with excessive force.**
- This may result in fire, injury, or problems with the product.
- Do not use this fan coil unit for long periods of time in badly ventilated locations or near infirm people.**
- Since this may be dangerous due to a lack of oxygen, open a window at least once an hour.
- ⊘ If any foreign substance such as water has entered the appliance, cut-off the power supply and contact the nearest service center.**
- Failing to do so may result in electric shock or fire.
- ⊘ Do not attempt to repair, disassemble, or modify the appliance yourself.**
- Do not use any fuse (such as copper, steel wire, etc.) other than the standard fuse.
 - Failing to do so may result in electric shock, fire, problems with the product, or injury.

 **CAUTION**

 **Do not place objects or devices under the fan coil unit.**

- Water dripping from the fan coil unit may result in fire or property damage.

Max current is measured according to IEC standard for safety and current is measured according to ISO standard for energy efficiency.

 **Do not stand on top of the appliance or place objects (such as laundry, lighted candles, lighted cigarettes, dishes, chemicals, metal objects, etc.) on the appliance.**

- This may result in electric shock, fire, problems with the product, or injury.

Do not operate the appliance with wet hands.

- This may result in electric shock.

Do not spray volatile material such as insecticide onto the surface of the appliance.

- As well as being harmful to humans, it may also result in electric shock, fire or problems with the product.

Do not drink the water from the fan coil unit.

- The water may be harmful to humans.

Do not apply a strong impact to the remote controller and do not disassemble the remote controller.

Do not touch the pipes connected with the product.

- This may result in burns or injury.

Do not use this fan coil unit to preserve precision equipment, food, animals, plants or cosmetics, or for any other unusual purposes.

- This may result in property damage.

Avoid directly exposing humans, animals or plants to the air flow from the fan coil unit for long periods of time.

- This may result in harm to humans, animals or plants.

Safety Information

- ⊘ This appliance is not intended for use by persons (including children) with reduced physical, sensory or mental capabilities, or lack of experience and knowledge, unless they have been given supervision or instruction concerning use of the appliance by a person responsible for their safety. Children should be supervised to ensure that they do not play with the appliance.

For use in Europe: This appliance can be used by children aged from 8 years and above and persons with reduced physical, sensory or mental capabilities or lack of experience and knowledge if they have been given supervision or instruction concerning use of the appliance in a safe way and understand the hazards involved. Children shall not play with the appliance. Cleaning and user maintenance shall not be made by children without supervision.

FOR CLEANING

WARNING

- ⊘ Do not clean the appliance by spraying water directly onto it. Do not use benzene, thinner, alcohol or acetone to clean the appliance.

- This may result in discoloration, deformation, damage, electric shock or fire.

Before cleaning or performing maintenance, cut-off the power supply and wait until the fan stops.

- Failing to do so may result in electric shock or fire.

CAUTION

- ⊘ Do not clean the inside of the fan coil unit by yourself.

- For cleaning inside the appliance, contact your nearest service center.
- When cleaning the internal filter, refer to the descriptions in the 'Cleaning and maintaining' section.
- Failure to do so may result in damage, electric shock or fire.

Fan Coil Unit Overview

The product appearance and labels may differ from the illustrations, depending on the model and panel type.

1WAY (PC1NUSMAN / PC1BWSMAN)

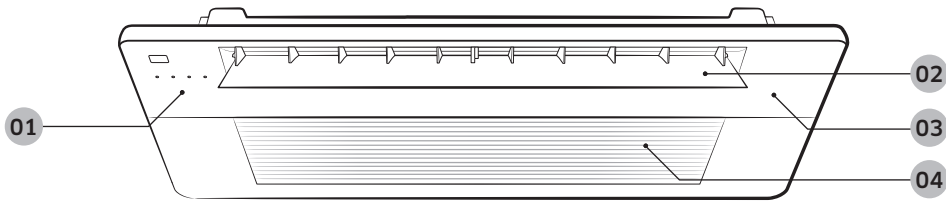

01 Display

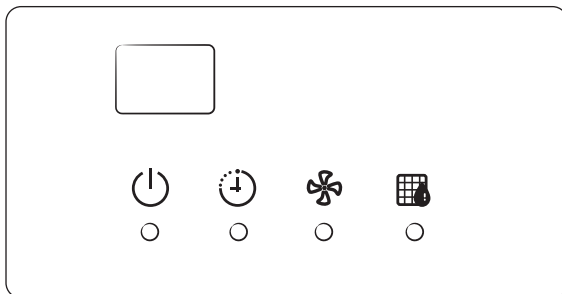

Indication	Function
	Remote control sensor
	Operation indicator
	Timer indicator
	Model not equipped with S-Plasma ion: Fan indicator Model equipped with S-Plasma ion: Purity indicator
	Filter reset indicator

02 Air flow blade

03 Panel

04 Air intake / Front grille / (inside) Air filter

NOTE

- Refer to the remote control user manual for details on how to use the product.
- The power button will not work. Use the remote control to turn on or off the product.
- When operating a Fan Coil Unit (including Fan mode), the S-Plasma Ion function may not operate automatically. In this case, turn on the Purity function with your remote control to activate the function.

Fan Coil Unit Overview

4WAY (PC4NUSKAN / PC4NUSKEN / PC4NBSKAN)

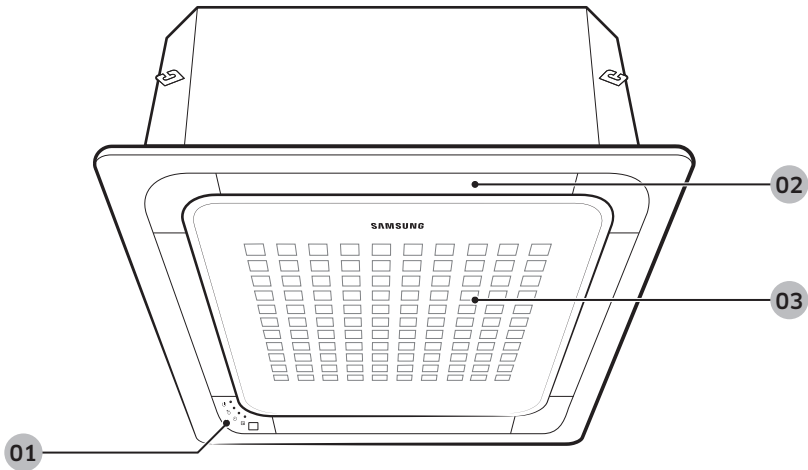

01 Display

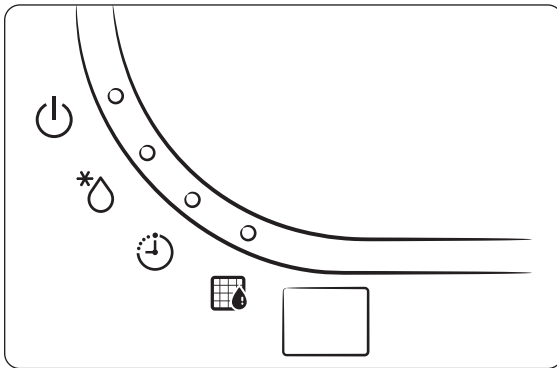

02 Air flow blade

03 Air intake / Front grille / (inside) Air filter

NOTE

- Each of the air flow blades can be controlled separately. Refer to the remote control user manual for details on how to use the product.

Note 1) The power button will not work. Use the remote control to turn on or off the product.

Note 2) The removing frost indicator does not work.

Indication	Function
	On/Off operation indicator ^{Note 1)}
	Removing frost indicator ^{Note 2)}
	Timer indicator
	Filter reset indicator
	Remote control sensor

360CST (PC4NUDMAN / PC4NUNMAN)

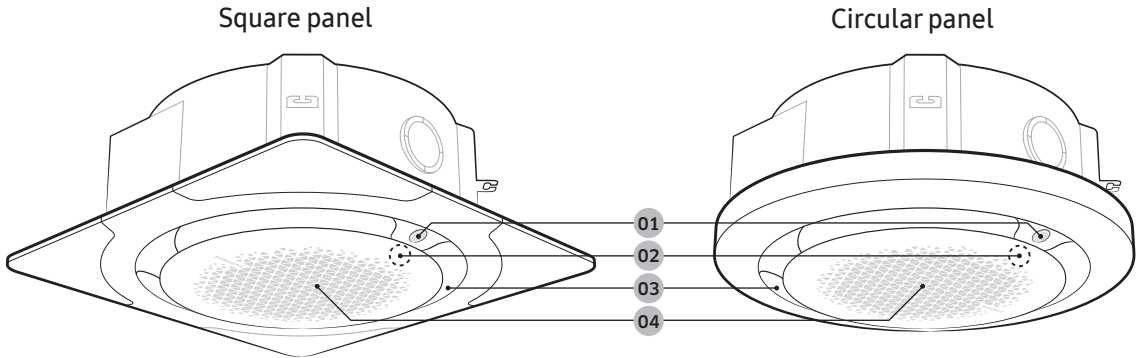

01 Display

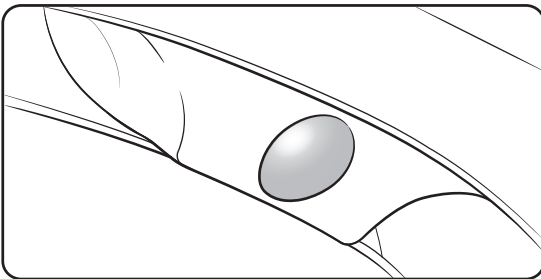



02 Remote control sensor (behind the front grille)

03 Air outlet

04 Air intake / Front grille / (inside) Air filter

NOTE

- For the AR-KHO** wireless remote control, the air flow direction indications appear on its display, too.
- By using the AR-KHO** wireless remote control, you can turn on or turn off the air flow direction indications that appear on the fan coil unit display.
- For the AR-EHO**, AR-ECO** wired remote control, which is designed generally for any fan coil unit, the air flow direction is not shown on the remote control display. Control the air flow direction with checking it on the fan coil unit display.
- For information on how to operate the product, see the user manual for the remote control.
- By using the AR-KHO** wireless remote control, which is designed specifically for the 360 cassette fan coil unit, you can operate them more conveniently. In addition, because you can check the operation status of each fan coil unit on the remote control, you can use the fan coil unit more effectively.

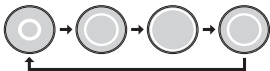
Operation status	Indication on the display
Power on	Ice blue (blinking)
In operation	Ice blue
Stopped	Off
Timed on/off function	Blue
Requires filter cleaning	Yellow green
Wide	
Mid	
Spot	
Swing	

Operation Features

If using the product in a location with temperature and humidity outside the standard operating range, the protective system activates and the product may not operate. Use the product under conditions with temperature and humidity within the standard operating range.

Operating temperature and humidity

Mode	Indoor temperature	Indoor humidity
Cool	18°C to 32°C	80% or less
Heat	30°C or less	-

NOTE

- Condensation may form on the product, if using Cool mode under high humidity conditions for an extended period of time.
- If operating the fan coil unit under conditions with water temperature over 65°C, protective control (shutdown) mode may activate to protect the product.

Cleaning and Maintaining

⚠ CAUTION

- Before cleaning, be sure to turn off the fan coil unit and the auxiliary power switch (MCCB, ELB).

Cleaning the fan coil unit

1WAY

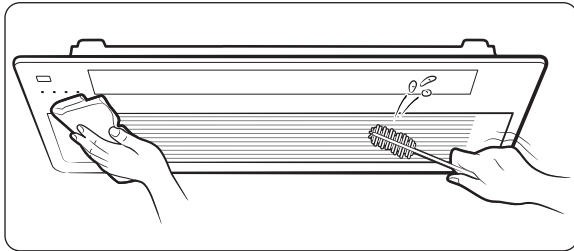

Wipe the surface of the unit with a slightly wet or dry cloth when needed. Wipe off dirt of odd-shaped areas by using a soft brush.

⚠ CAUTION

- Do not use alkaline detergent, sulphuric acid, hydrochloric acid, or organic solvents (such as thinner, kerosene, and acetone) to clean the surfaces.
- Do not attach any stickers on the surfaces because this may cause damage.
- When you clean the heat exchanger on the fan coil unit, you need to disassemble the fan coil unit. Therefore, you must contact the local service center for help.

4WAY

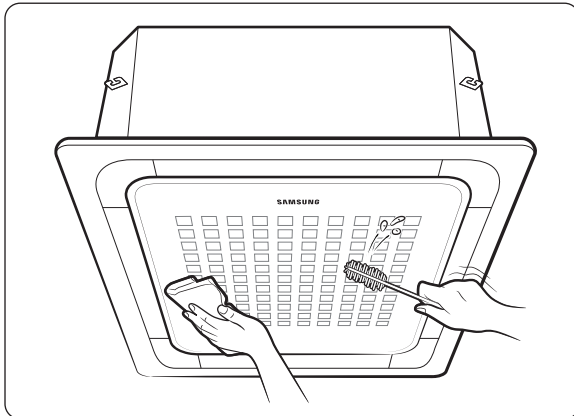

360CST

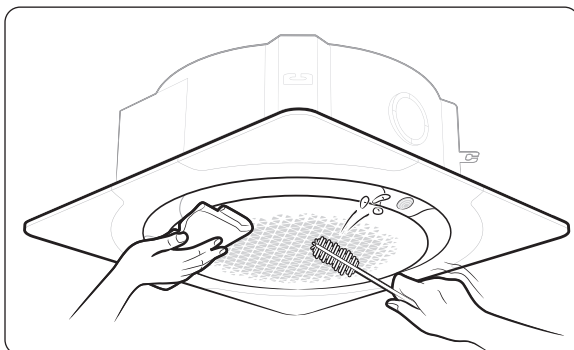

Cleaning and Maintaining

Cleaning the air filter

⚠ CAUTION

- Before cleaning, be sure to turn off the fan coil unit and the auxiliary power switch (MCCB, ELB).
- Be sure to hold the grille with a hand to prevent dropping from the opening of the front grille.

1 WAY

1 Detaching and replacing the air filter

PC1NUSMAN

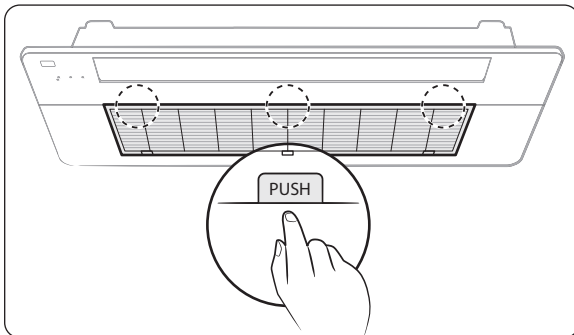

Press the **Push** signs on the front panel, then open the grille.

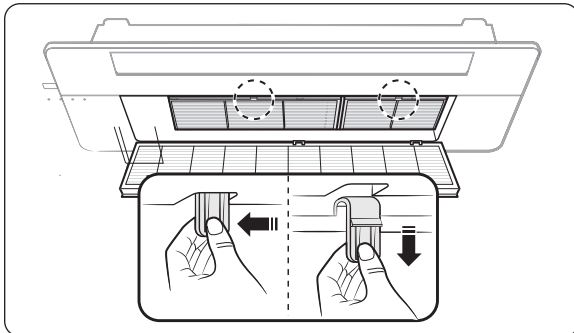

Grab the handle of the air filter and lift it upward while pushing the handle slightly.

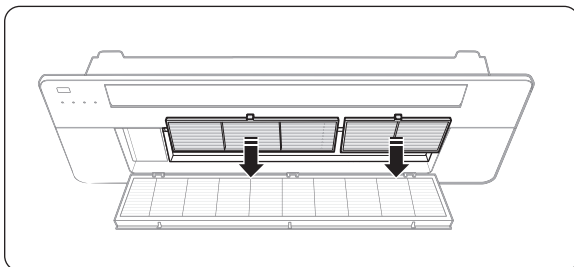

Pull out the air filter from the fan coil unit.

PC1BWSMAN

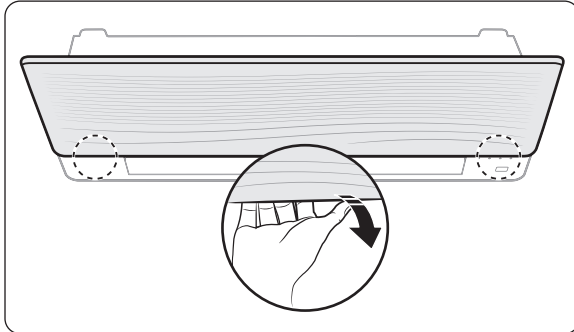

Insert your hand into the front grille and pull out the front grille to open it.

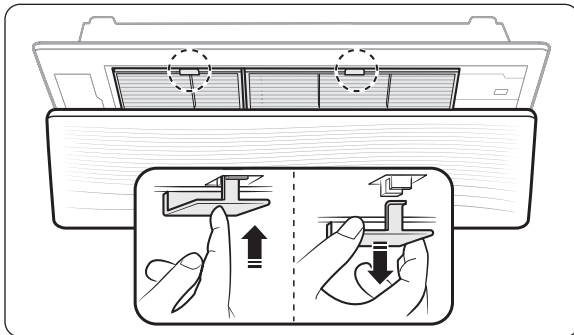

Press the **Push** signs on the air filter.
Grab the handle of the air filter with your hand.

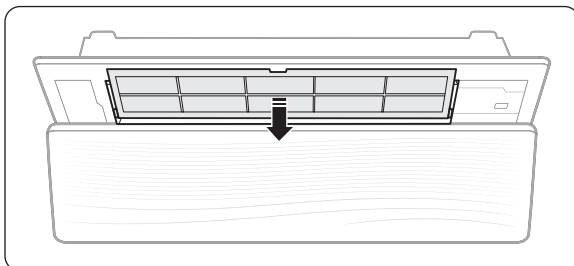

Pull out the air filter from the fan coil unit.

Cleaning and Maintaining

2 Cleaning the air filter

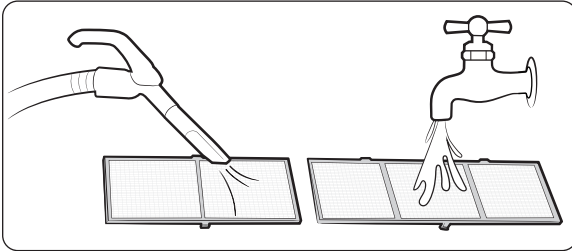

Clean the air filter with a vacuum cleaner or soft brush. If dust is too heavy, then rinse it with running water.

⚠ CAUTION

Do not scrub the air filter with a brush or other cleaning utensil. This may damage the filter.

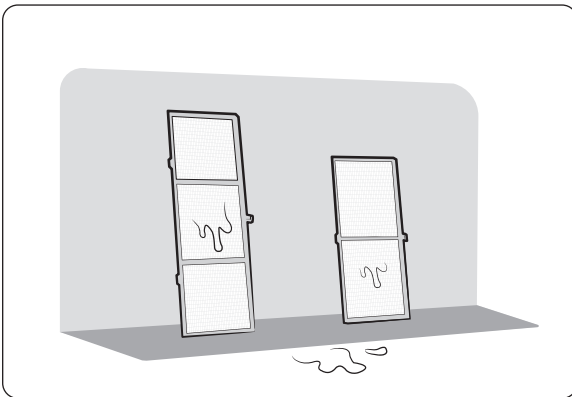

📄 NOTE

- Unpleasant smells or unusual noises may come from the filter if it is very dirty. If this is the case, immerse the filter in warm water with a neutral detergent for about 30 minutes and then rinse it thoroughly.
- Lean the filter against a wall to maximise air contact for drying, in the shade with no direct sunlight, for at least 12 hours.
- If the air filter dries in a humid area, it may produce offensive odours. Clean it again and dry it in a well-ventilated area.
- The cleaning period may differ depending on the usage and environmental conditions, so clean the air filter every week if the fan coil unit is in the dusty area.

3 Reassembling the air filter

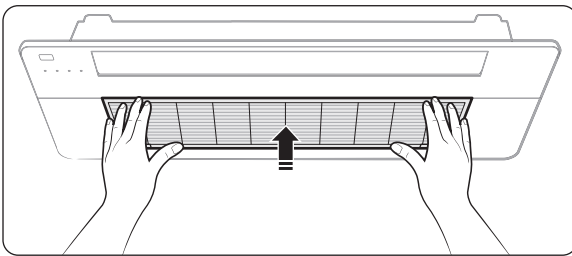
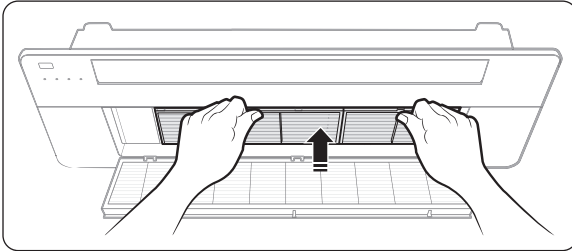

⚠ CAUTION

- If the fan coil unit is used without the air filter, it may be damaged due to dust.

4 Resetting the air filter

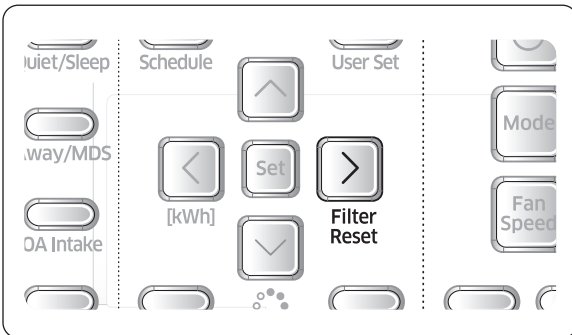

After cleaning and reassembling the air filter, be sure to reset the filter-cleaning reminder as follows:

- Fan coil unit with the wired remote control: Press the **Filter Reset** button.
- Fan coil unit with the wireless remote control: Press the **Settings** button → < or > → (**Filter Reset**) Blinking → press the **SET** button.

📖 NOTE

- Be sure to reset the filter-cleaning reminder every time you clean the air filter although the filter reset indicator (📊) does not blink.

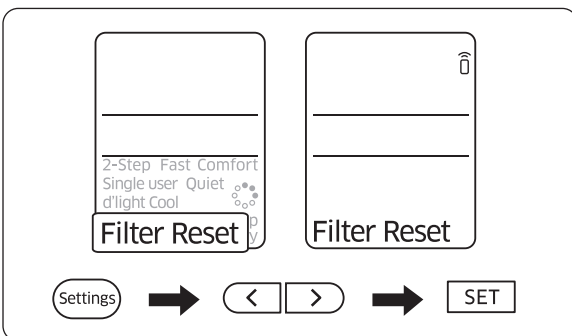

Cleaning and Maintaining

4 WAY

1 Detaching and replacing the air filter

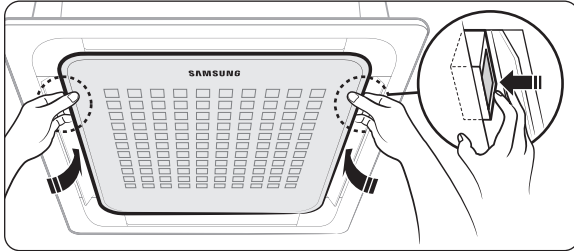

Open the air flow blades on both sides of the front grille, then open the front grille by pushing the two push-buttons.

NOTE

- The push-buttons are located on both sides of the front grill with the Samsung logo.
- You can find the buttons by opening the air flow blades with your hands.

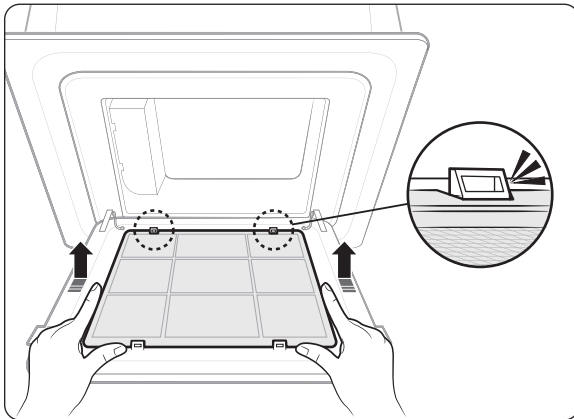

Pull out the air filter from the fan coil unit.

2 Cleaning the air filter

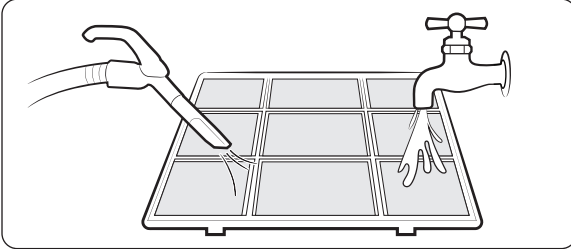

Clean the air filter with a vacuum cleaner or soft brush. If dust is too heavy, then rinse it with running water.

CAUTION

Do not scrub the air filter with a brush or other cleaning utensil. This may damage the filter.

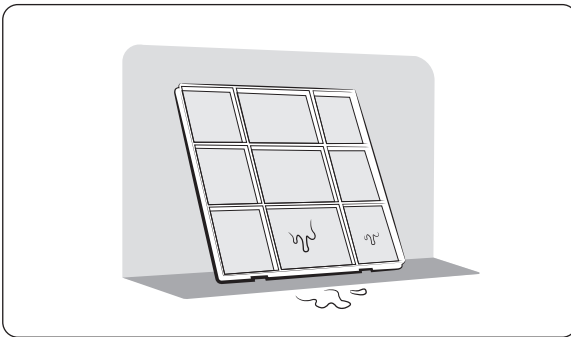

NOTE

- Unpleasant smells or unusual noises may come from the filter if it is very dirty. If this is the case, immerse the filter in warm water with a neutral detergent for about 30 minutes and then rinse it thoroughly.
- Lean the filter against a wall to maximise air contact for drying, in the shade with no direct sunlight, for at least 12 hours.
- If the air filter dries in a humid area, it may produce offensive odours. Clean it again and dry it in a well-ventilated area.
- The cleaning period may differ depending on the usage and environmental conditions, so clean the air filter every week if the fan coil unit is in the dusty area.

Cleaning and Maintaining

3 Reassembling the air filter

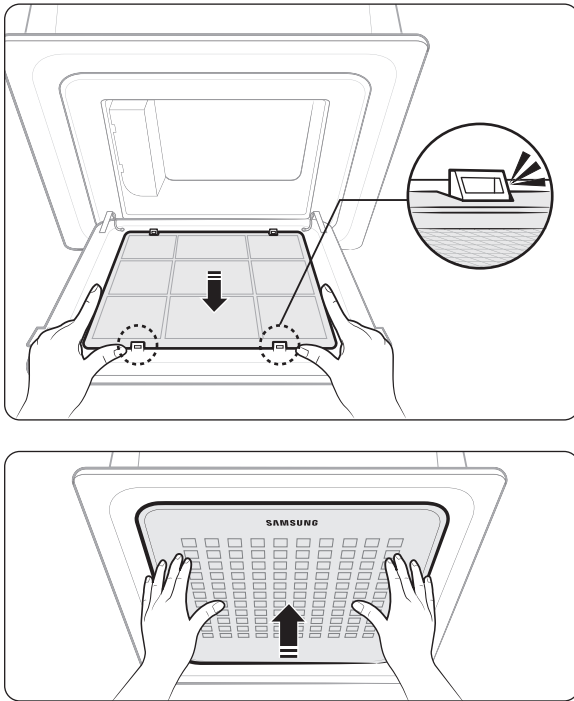

⚠ CAUTION

- If the fan coil unit is used without the air filter, the fan coil unit may be damaged due to dust.

4 Resetting the air filter

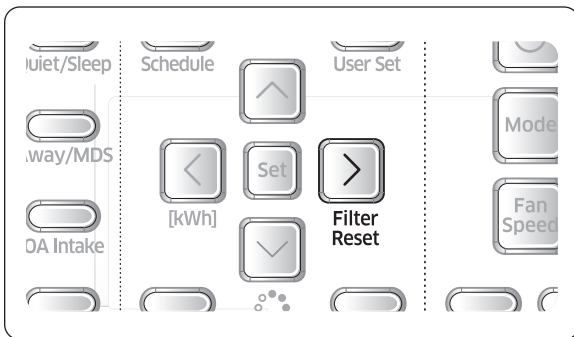

After cleaning and reassembling the air filter, be sure to reset the filter-cleaning reminder as follows:

- Fan coil unit with the wired remote control: Press the **Filter Reset** button.
- Fan coil unit with the wireless remote control: Press the **Settings** button → < or > → (**Filter Reset**) Blinking → press the **SET** button.

📄 NOTE

- The filter reset indicator blinks when the air filter should be cleaned.
- If the angle of the air flow blade is changed by opening the front grille for installation or maintenance of the fan coil unit, be sure to turn off and then on the auxiliary switch before operating the fan coil unit again. If not, the angle of the air flow blade may be changed and the blades may not be closed after turning off the fan coil unit.

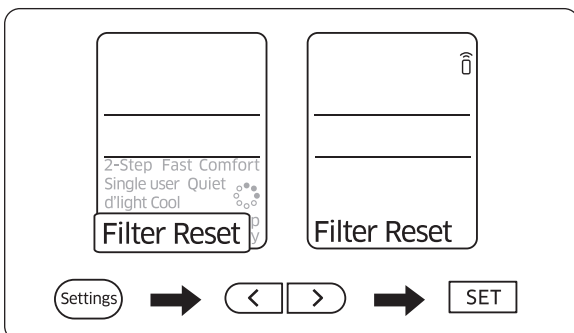

360 CST

1 Detaching and replacing the air filter

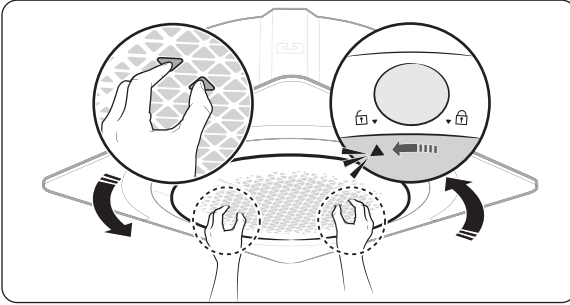

Rotate the grill inlet counter-clockwise to detach it from the fan coil unit body.

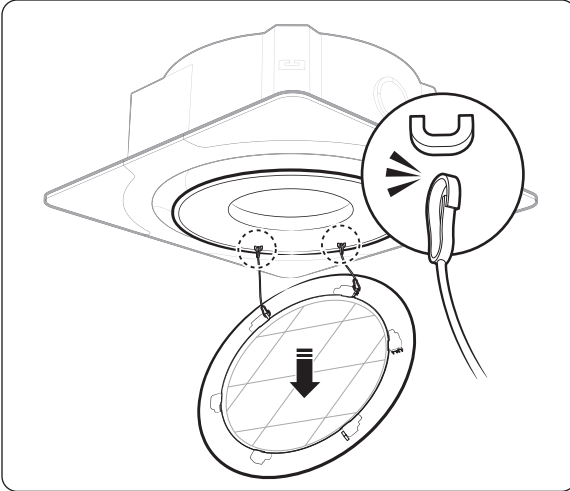

Unhook the two hook wires of the grille inlet from the two wire hooks on the fan coil unit body.

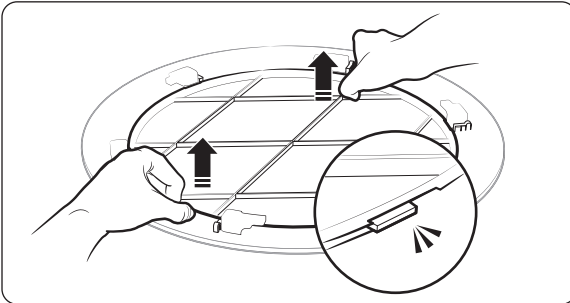

Pull out the air filter from the grille inlet.

CAUTION

For cleaning and maintenance, be sure to turn off the circuit breaker.

NOTE

- When the next filter-cleaning time arrives (after 1000 hours of operation), the fan coil unit display appears in yellow green.

Cleaning and Maintaining

2 Cleaning the air filter

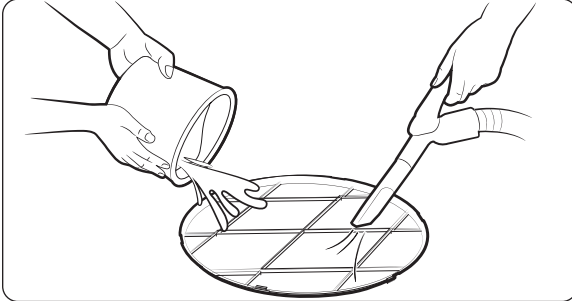

Clean the air filter with a vacuum cleaner or soft brush. If dust is too heavy, then rinse it with running water.

NOTE

- Clean the air filter once every two weeks.
- Spray water or use a vacuum cleaner to remove dust.

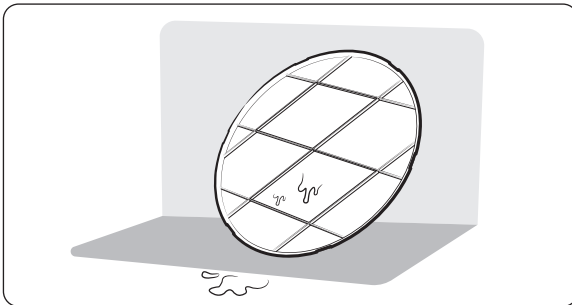

After removing dust, dry the air filter completely.

- Avoid direct sunlight. Failure to do so may deform the air filter.

NOTE

- If the air filter dries in a humid area, it may produce offensive odours. Clean it again and dry it in a well-ventilated area.

3 Reassembling the air filter

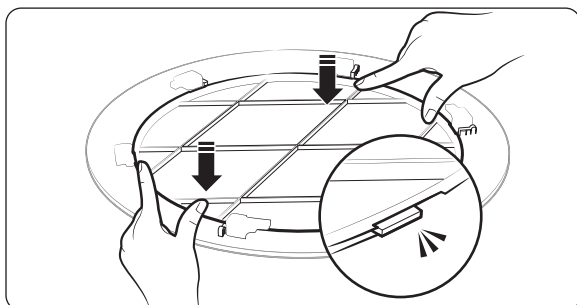

Install the air filter to the grille inlet.

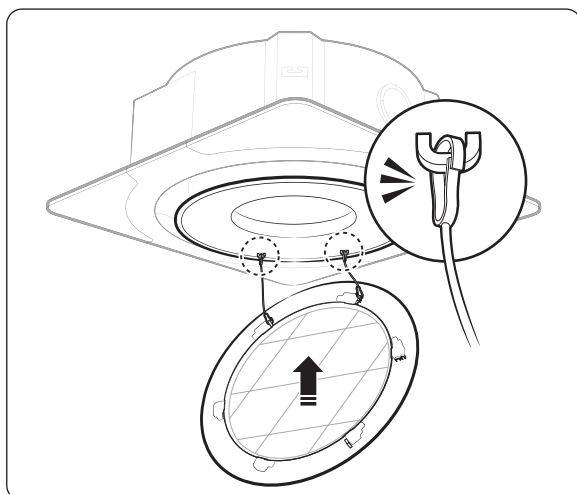

Hook the two hook wires of the grille inlet onto the two wire hooks on the fan coil unit body.

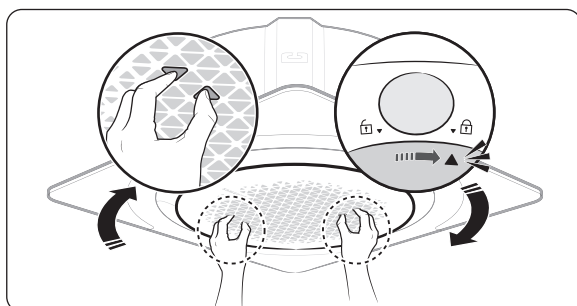

Rotate the grill inlet clockwise until you hear "click" so that it is assembled firmly in place. Make sure that the grill inlet is firmly fixed to the fan coil unit body.

4 Resetting the air filter

After cleaning and reassembling the air filter, reset the filter-cleaning reminder as follows:

- AR-KH0** remote control: **Options** > Select **Filter Reset**.
- AR-EH0**, AR-ECO** remote control: Hold down the **Filter Reset** button for two seconds.

NOTE

- If you try to assemble the air filter upside down, it will not be assembled because it cannot be clamped by the internal structure.



Cleaning and Maintaining

Periodical maintenance

Maintenance item	Interval	Requires qualified technicians
Clean the air filter.	At least once a month	
Clean the condensate drain pan.	Once a year	Required
Clean up the heat exchange.	Once a year	Required
Clean the condensate drain pipe.	Once every 4 months	Required
Replace the remote control batteries.	At least once a year	



Troubleshooting

Refer to the following chart if the fan coil unit operates abnormally. This may save time and unnecessary expense.

Problem	Solution
<p>The fan coil unit does not operate at all.</p>	<ul style="list-style-type: none"> • Check if the power plug is properly connected. • Check whether the auxiliary power switch (MCCB, ELB) is turned on. If the auxiliary power switch (MCCB, ELB) is turned off, the fan coil unit does not work although you press the  (Power) button. • If the fan coil unit is turned off by the Timed off function, turn on the fan coil unit again by pressing the  (Power) button.
<p>The temperature does not change.</p>	<ul style="list-style-type: none"> • Check whether the Fan mode is running. In the Fan mode, the fan coil unit controls the set temperature automatically, and you cannot change the set temperature.
<p>The air is not cool or warm enough.</p>	<ul style="list-style-type: none"> • In the Cool mode, cool air does not come out if the set temperature is higher than the current temperature. <ul style="list-style-type: none"> – AR-EH0**, AR-EC0** remote control: Press the Temperature button repeatedly until the set temperature (minimum: 18°C) is set to lower than the current temperature. – AR-KH0** remote control: Press the Temperature button on the remote control. Then rotate the Wheel until the set temperature (minimum: 18°C) is set to lower than the current temperature. • In the Heat mode, warm air does not come out if the set temperature is lower than the current temperature. (only for the models for both heating and cooling) <ul style="list-style-type: none"> – AR-EH0**, AR-EC0** remote control: Press the Temperature button repeatedly until the set temperature (maximum: 30°C) is set to higher than the current temperature. – AR-KH0** remote control: Press the Temperature button on the remote control. Then rotate the Wheel until the set temperature (maximum: 30°C) is set to higher than the current temperature. • Check whether the air filter is blocked with dirt. A dusty filter may decrease the cooling and heating efficiencies. Clean the air filter frequently. • If the fan coil unit is installed in a place exposed to direct sunlight, pull the curtains on the windows. • Close the windows and doors to maximize the cooling and heating efficiencies.

Cleaning and Maintaining

Problem	Solution
<p>The air is not cool or warm enough.</p>	<ul style="list-style-type: none"> • Performance may degrade if the fan coil unit is full of air. If this is the case, release the air. • Check the cool/hot water supply line to ensure that the water pipe system valve is open. If this valve is locked, cold and hot water does not circulate properly, and cooling and heating do not work. Open the main valve. • Cooling and heating may not work if the flow rate of circulating water is insufficient. Contact the installer. • There may be heat loss in the water pipe system. Insulate all pipes to prevent heat loss. • Cooling and heating may not work if there is leakage in piping joints due to damaged or loose valve pipes or joints. Contact the installer.
<p>The fan speed does not change.</p>	<ul style="list-style-type: none"> • If Auto mode is on, the fan speed is automatically set and cannot be changed.
<p>The air flow blades does not move.</p>	<ul style="list-style-type: none"> • In Heat mode, the air flow blades are fixed upwards in summer off state, but the blades are fixed downwards if there is no cool air.
<p>The wireless remote control does not operate.</p>	<ul style="list-style-type: none"> • Check whether the batteries are discharged. Replace the batteries with new ones. • Make sure that nothing is blocking the remote control sensor. • Check whether any strong lighting sources are near the fan coil unit. Strong light which comes from fluorescent bulbs or neon signs may interfere with the remote control.
<p>The wired remote control does not operate.</p>	<ul style="list-style-type: none"> • If the indicator at the bottom right of the remote control is lit, stop the fan coil unit, turn off the UPS switch, and then contact a service centre.
<p>The fan coil unit is not turned on or off immediately with the wired remote control.</p>	<ul style="list-style-type: none"> • Check whether the wired remote control is set for group control. In this case, the fan coil units connected to the wired remote control are turned on or off sequentially. This operation takes up to 32 seconds.
<p>The Timed on/off function does not operate.</p>	<ul style="list-style-type: none"> • Timed on/off function is saved if the [SET] button ([SET/CANCEL] for previous models) is not pressed after specifying the time. Specify the time, and press the [SET] ([SET/CANCEL]) button.

Problem	Solution
<p>Unpleasant odours permeate the room.</p>	<ul style="list-style-type: none"> • If the product is used in a smelly or smoky place, ventilate the place. <ul style="list-style-type: none"> – You may experience unpleasant smells if the indoor temperature and humidity are high. Operate the product in Clean or Fan mode for 1 to 2 hours. • Clean the dust filter if it is dirty.
<p>The fan coil unit display blinks continuously.</p>	<ul style="list-style-type: none"> • Press the  (Power) button to turn on the fan coil unit. • Turn off and then turn on the auxiliary power switch, and then turn on the fan coil unit. • If the fan coil unit display is still blinking, contact a service centre.
<p>Condensation forms on the product.</p>	<ul style="list-style-type: none"> • If using Cool mode with doors open, humid air touches the air outlet and condensation may form on the panel and heater. Close the doors.
<p>The fan coil unit makes strange noises.</p>	<ul style="list-style-type: none"> • The drain pump inside the product may make operation noises immediately after the  (Power) button is pressed. This noise is a normal sound. • The product may make some noises when detecting the position of the air flow blades immediately after the  (Power) button is pressed. This noise is a normal sound. • You may hear a sound of water running if the product is full of air. If this is the case, release the air. • The product may make noises if water hammers occur. Contact the installer.

Cleaning and Maintaining

Technical specifications

Model	New weight	Net dimension(W x D x H)
AG026MN1DEH/EU	10.5kg	970*135*410
AG032MN1DEH/EU	10.5kg	970*135*410
AG042MN1DEH/EU	14.0kg	1,200*138*450
AG060MN4DKH/EU	15.5kg	840*204*840
AG072MN4DKH/EU	15.5kg	840*204*840
AG090MN4DKH/EU	18.0kg	840*246*840
AG105MN4DKH/EU	18.0kg	840*246*840
AG060MN4PKH/EU	21.0kg	947*281*947
AG072MN4PKH/EU	25.0kg	947*365*947
AG090MN4PKH/EU	25.0kg	947*365*947
AG105MN4PKH/EU	25.0kg	947*365*947

MEMO

QUESTIONS OR COMMENTS?

COUNTRY	CALL	OR VISIT US ONLINE AT
UK	0333 000 0333	www.samsung.com/uk/support
IRELAND (EIRE)	0818 717100	www.samsung.com/ie/support
GERMANY	06196 77 555 77	www.samsung.com/de/support
FRANCE	01 48 63 00 00	www.samsung.com/fr/support
SPAIN	91 175 00 15	www.samsung.com/es/support
PORTUGAL	808 207 267	www.samsung.com/pt/support
LUXEMBURG	261 03 710	www.samsung.com/be_fr/support
NETHERLANDS	088 90 90 100	www.samsung.com/nl/support
BELGIUM	02-201-24-18	www.samsung.com/be/support (Dutch) www.samsung.com/be_fr/support (French)
NORWAY	21629099	www.samsung.com/no/support
DENMARK	707 019 70	www.samsung.com/dk/support
FINLAND	030-6227 515	www.samsung.com/fi/support
SWEDEN	0771 726 786	www.samsung.com/se/support
AUSTRIA	0800 72 67 864 (0800-SAMSUNG)	www.samsung.com/at/support
SWITZERLAND	0800 726 786	www.samsung.com/ch/support (German) www.samsung.com/ch_fr/support (French)
HUNGARY	0680SAMSUNG (0680-726-7864)	www.samsung.com/hu/support
CZECH	800 - SAMSUNG (800-726786)	www.samsung.com/cz/support
SLOVAKIA	0800 - SAMSUNG (0800-726 786)	www.samsung.com/sk/support
CROATIA	072 726 786	www.samsung.com/hr/support
BOSNIA	055 233 999	www.samsung.com/ba/support
North Macedonia	023 207 777	www.samsung.com/mk/support
MONTENEGRO	020 405 888	www.samsung.com/support
SLOVENIA	080 697 267 (brezplačna številka)	www.samsung.com/si/support
SERBIA	011 321 6899	www.samsung.com/rs/support
KOSOVO	0800 10 101	www.samsung.com/support
ALBANIA	045 620 202	www.samsung.com/al/support
BULGARIA	*3000 Цена на един зградски разговор 0800 111 31 Безплатен за всички оператори	www.samsung.com/bg/support
ROMANIA	*8000 (apel in retea) 08008-726-78-64 (08008-SAMSUNG) Apel GRATUIT Atenție: Dacă efectuați apelul din rețeaua Digi (RCS/RDS), vă rugăm să ne contactați formând numărul Telverde fără ultimele două cifre, astfel: 0800872678.	www.samsung.com/ro/support
ITALIA	800-SAMSUNG (800.7267864)	www.samsung.com/it/support
CYPRUS	8009 4000 only from landline, toll free	www.samsung.com/gr/support
GREECE	80111-SAMSUNG (80111 726 7864) only from land line (+30) 210 6897691 from mobile and land line	
POLAND	801-172-678* lub +48 22 607-93-33* * (opłata według taryfy operatora)	http://www.samsung.com/pl/support/
LITHUANIA	8-800-77777	www.samsung.com/lt/support
LATVIA	8000-7267	www.samsung.com/lv/support
ESTONIA	800-7267	www.samsung.com/ee/support

Samsung, PO Box 12987, Blackrock, Co. Dublin. Ireland
or Blackbushe Business Park, Yateley, GU46 6GG. UK

