

Air conditioner

Installation manual

AC***RNCDKG

- Thank you for purchasing this Samsung air conditioner.
- Before operating this unit, please read this manual carefully and retain it for future reference.



DB68-08133A-04

SAMSUNG

Contents

Safety Information	3
Installation Procedure	5
Step 1 Checking and preparing accessories	5
Step 2 Choosing the installation location	6
Step 3 Installing the indoor unit	8
Step 4 Purging inert gas from the indoor unit	10
Step 5 Cutting and flaring the pipes	11
Step 6 Connecting the assembly pipes to the refrigerant pipes	11
Step 7 Performing the gas leak test	12
Step 8 Insulating the refrigerant pipes	13
Step 9 Installing the drain hose and drain pipe	14
Step 10 Optional: Installing DPM	15
Step 11 Optional: Installing interface module	15
Step 12 Connecting the power and communication cables	16
Step 13 Optional: Extending the power cable	17
Step 14 Setting the indoor unit addresses and the installation options	18
Appendix	28
Troubleshooting	28

Safety Information

WARNING

- Hazards or unsafe practices that may result in severe personal injury or death.

CAUTION

- Hazards or unsafe practices that may result in minor personal injury or property damage.
- Carefully follow the precautions listed below because they are essential to guarantee the safety of the equipment.

WARNING

- Always disconnect the air conditioner from the power supply before servicing it or accessing its internal components.
- Verify that installation and testing operations are performed by qualified personnel.
- Verify that the air conditioner is not installed in an easily accessible area.

General information

WARNING

- Carefully read the content of this manual before installing the air conditioner and store the manual in a safe place in order to be able to use it as reference after installation.
- For maximum safety, installers should always carefully read the following warnings.
- Store the operation and installation manual in a safe location and remember to hand it over to the new owner if the air conditioner is sold or transferred.
- This manual explains how to install an indoor unit with a split system with two SAMSUNG units. The use of other types of units with different control systems may damage the units and invalidate the warranty. The manufacturer shall not be responsible for damages arising from the use of non compliant units.
- The manufacturer shall not be responsible for damage originating from unauthorized changes or the improper connection of electric and requirements set forth in the "Operating limits" table, included in the manual, shall immediately invalidate the warranty.

- The air conditioner should be used only for the applications for which it has been designed: the indoor unit is not suitable to be installed in areas used for laundry.
- Do not use the units if damaged. If problems occur, switch the unit off and disconnect it from the power supply.
- In order to prevent electric shocks, fires or injuries, always stop the unit, disable the protection switch and contact SAMSUNG's technical support if the unit produces smoke, if the power cable is hot or damaged or if the unit is very noisy.
- Always remember to inspect the unit, electric connections, refrigerant tubes and protections regularly. These operations should be performed by qualified personnel only.
- The unit contains moving parts, which should always be kept out of the reach of children.
- Do not attempt to repair, move, alter or reinstall the unit. If performed by unauthorized personnel, these operations may cause electric shocks or fires.
- Do not place containers with liquids or other objects on the unit.
- All the materials used for the manufacture and packaging of the air conditioner are recyclable.
- The packing material and exhaust batteries of the remote controller(optional) must be disposed of in accordance with current laws.
- The air conditioner contains a refrigerant that has to be disposed of as special waste. At the end of its life cycle, the air conditioner must be disposed of in authorised centres or returned to the retailer so that it can be disposed of correctly and safely.
- Wear protective equipment (such as safety gloves, goggles, and headgear) during installation and maintenance works. Installation/repair technicians may be injured if protective equipment is not properly equipped.
- Do not use means to accelerate the defrost operation or to clean, other than those recommended by Samsung.
- Do not pierce or burn.
- Be aware that refrigerants may not contain an odour.

Installing the unit

WARNING

IMPORTANT: When installing the unit, always remember to connect first the refrigerant tubes, then the electrical lines.

Safety Information

- Always disassemble the electric lines before the refrigerant tubes.
- Upon receipt, inspect the product to verify that it has not been damaged during transport. If the product appears damaged, DO NOT INSTALL it and immediately report the damage to the carrier or retailer (if the installer or the authorized technician has collected the material from the retailer.)
- After completing the installation, always carry out a functional test and provide the instructions on how to operate the air conditioner to the user.
- Do not use the air conditioner in environments with hazardous substances or close to equipment that release free flames to avoid the occurrence of fires, explosions or injuries.
- Our units should be installed in compliance with the spaces shown in the installation manual, to ensure accessibility from both sides and allow repairs or maintenance operations to be carried out. The unit's components should be accessible and easy to disassemble without endangering people and objects. For this reason, when provisions of the installation manual are not complied with, the cost required to access and repair the units (in SAFETY CONDITIONS, as set out in prevailing regulations) with harnesses, ladders, scaffolding or any other elevation system will NOT be considered part of the warranty and will be charged to the end customer.
- Verify that the air conditioner is connected to the power supply in accordance with the instructions provided in the wiring diagram included in the manual.
- Always verify that electric connections (cable entry, section of leads, protections..) are compliant with the electric specifications and with the instructions provided in the wiring scheme. Always verify that all connections comply with the standards applicable to the installation of air conditioners.
- Devices disconnected from the power supply should be completely disconnected in the condition of overvoltage category.
- Be sure not to perform power cable modification, extension wiring, and multiple wire connection.
 - It may cause electric shock or fire due to poor connection, poor insulation, or current limit override.
 - When extension wiring is required due to power line damage, refer to "**Step 12 Optional: Extending the power cable**" in the installation manual.

CAUTION

Make sure that you earth the cables.

- Do not connect the earth wire to the gas pipe, water pipe, lighting rod or telephone wire. If earthing is not complete, electric shock or fire may occur.

Install the circuit breaker.

- If the circuit breaker is not installed, electric shock or fire may occur.

Make sure that the condensed water dripping from the drain hose runs out properly and safely.

Install the power cable and communication cable of the indoor and outdoor unit at least 1m away from the electric appliance.

Install the indoor unit away from lighting apparatus using the ballast.

- If you use the wireless remote control, reception error may occur due to the ballast of the lighting apparatus.

Do not use the indoor unit for preservation of food items, plants, equipment, and art works. This may cause deterioration of their quality.

Do not install the indoor unit if it has any drainage problem.

Power supply line, fuse or circuit breaker

WARNING





- Always make sure that the power supply is compliant with current safety standards. Always install the air conditioner in compliance with current local safety standards.
- Always verify that a suitable grounding connection is available.
- Verify that the voltage and frequency of the power supply comply with the specifications and that the installed power is sufficient to ensure the operation of any other domestic appliance connected to the same electric lines.
- Always verify that the cut-off and protection switches are suitably dimensioned.

Installation Procedure



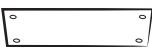
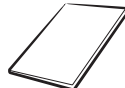
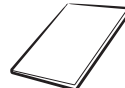
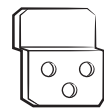

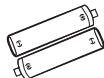
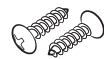

Step 1 Checking and preparing accessories

The following accessories are supplied with the indoor unit.

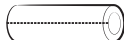
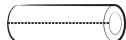
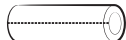
AC052/071RNCCKG

Pattern sheet (1)	User manual (1)	Installation manual (1)	Plate Hanger (2)	Cable-Tie (5)
				
Wireless Remote Controller (1)	Remote Controller Holder (1)	Batter (2)	M4 X 16 Tapped Screw (2)	
				

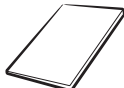
AC100/120/140RNCCKG

Pattern sheet (2)	Insulation cover pipe A (1)	Insulation cover pipe B (1)	Insulation drain (1)
			
Flexible hose clamp (1)	Flexible hose (1)	Cable-tie (8)	User manual (1)
			
Installation manual (1)	Insulation (3)	Rubber (4)	
			

Installation Procedure

Step 2 Choosing the installation location

CAUTION

- This product must be installed on the ceiling. (Do not make it stand up for use.)

Installation location requirements

- There must be no obstacles near the air inlet and outlet.
- Install the indoor unit on a ceiling that can support its weight.
- Maintain sufficient clearance around the indoor unit.
- Before installing the indoor unit, be sure to check whether the chosen location is well-drained.

WARNING

- If appliances contain R-32 refrigerant, then the floor area of the room in which the appliances are installed, operated and stored must be larger than the minimum floor area defined in table below A (m²).

Minimum required room area (A, m ²)	
m (kg)	Ceiling-mounted type
≤ 1.842	No requirement
1.843	3.64
1.9	3.75
2.0	3.95
2.2	4.34
2.4	4.74
2.6	5.13
2.8	5.53
3.0	5.92
3.2	6.48
3.4	7.32
3.6	8.20
3.8	9.14
4.0	10.1
4.2	11.2
4.4	12.3
4.6	13.4
4.8	14.6
5.0	15.8
5.2	17.1

- m : Total refrigerant charge in the system
- A : Minimum required room area

- IMPORTANT: it's mandatory to consider either the table 1 or taking into consideration the local law regarding the minimum living space of the premises.
- Minimum installation height of indoor unit is 0.6 m for floor mounted, 1.8 m for wall, 2.2 m for ceiling.

CAUTION

Do not install the air conditioner in following places.

- The place where there is mineral oil or arsenic acid. Resin parts flame and the accessories may drop or water may leak. The capacity of the heat exchanger may reduce or the air conditioner may be out of order.
- The place where corrosive gas such as sulfurous acid gas generates from the vent pipe or air outlet. The copper pipe or connection pipe may corrode and refrigerant may leak.
- The place where there is a machine that generates electromagnetic waves. The air conditioner may not operate normally due to control system.
- The place where there is a danger of existing combustible gas, carbon fiber or flammable dust.
- The place where thinner or gasoline is handled. Gas may leak and it may cause fire.

Indoor unit dimensions

AC052/071RNCDKG

(Unit: mm)

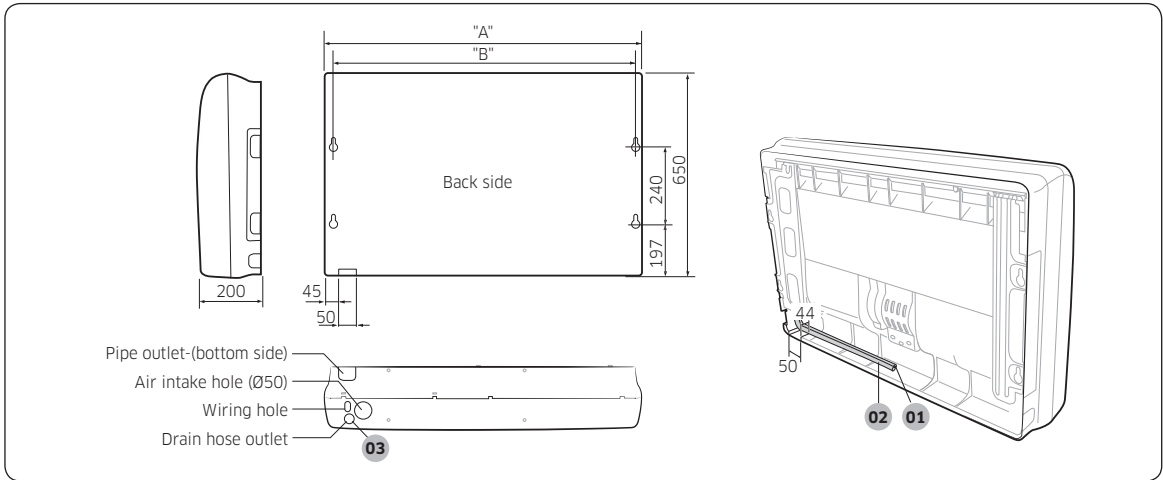

AC100/120/140RNCDKG

(Unit: mm)

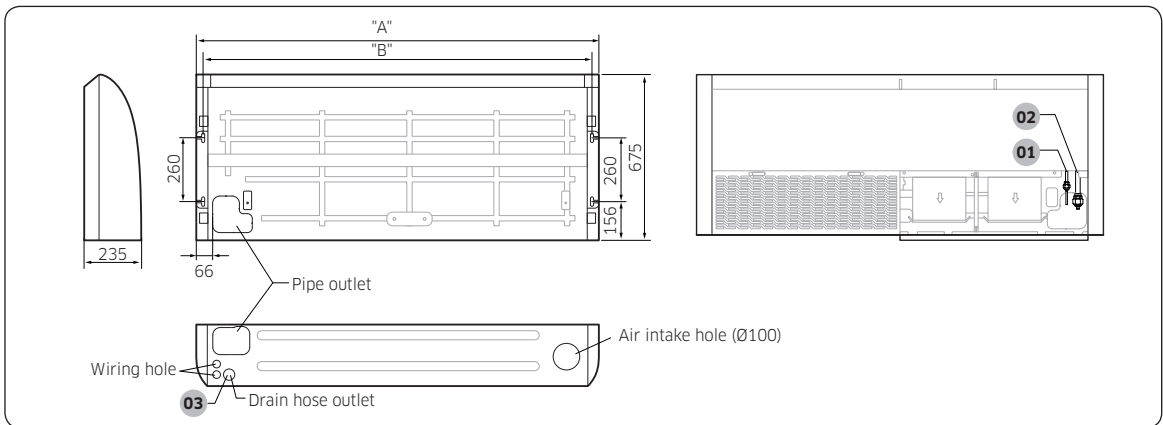

(Unit: mm)

Model	Dimension		1	2	3
	"A"	"B"	Liquid pipe connection	Gas pipe connection	Drain pipe connection
AC052RNCDKG	1000	922	ø6.35 (1/4")	ø12.70 (1/2")	ID ø18 Hose
AC071RNCDKG	1000	922	ø6.35 (1/4")	ø15.88 (5/8")	ID ø18 Hose
AC100/120/140RNCDKG	1650	1598	ø9.52 (3/8")	ø15.88 (5/8")	OD ø25; ID ø20

Installation Procedure

Spacing requirements

AC052/071RNCDKG

Ceiling installation

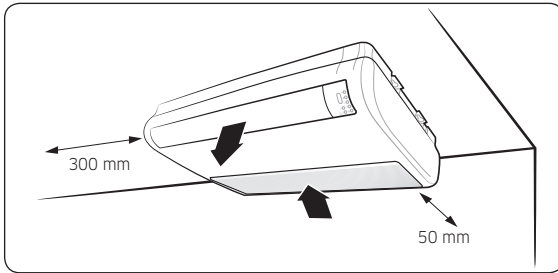

AC100/120/140RNCDKG

Ceiling installation

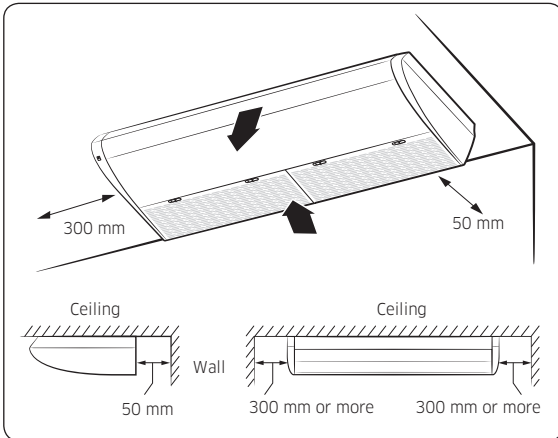

- 2 Drill holes for anchor bolts according to the distance and mount them.

NOTE

- Use the pattern sheet.
- 3 Install the unit onto the ceiling. Be sure to arrange the drain hose so that it is leveled lower than the drain hose connecting port of the indoor unit.

NOTE

- For proper drainage of condensate, give a 1° or less slant to the side of the unit which will be connected to the drain hose as shown in the figure. (The gap between the lower end of the indoor unit and the ceiling should be 12 mm or less.)

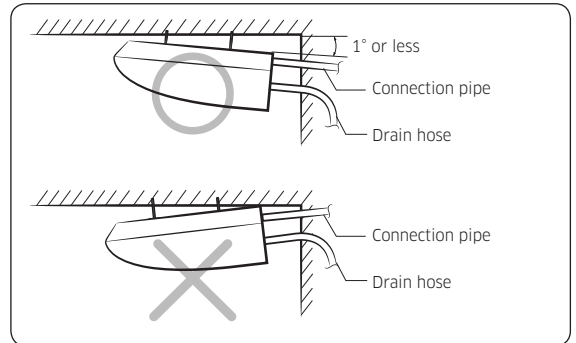

CAUTION

- Ensure that the ceiling is strong enough to support the weight of the indoor unit.
- Before hanging the unit, test the strength of each attached suspension bolt.
- Install the drain hose from the rear of the unit.

NOTE

- The gap between the lower end of the indoor unit and the ceiling should be 1° (16 mm) or less.

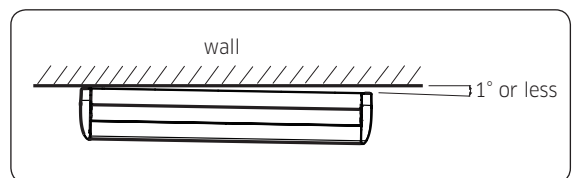

Step 3 Installing the indoor unit

Ceiling installation (AC052/071RNCDKG)

- 1 Select pipe directions.

When the directions are selected, drill $3\text{-}1/8\text{'}$ -(100mm, for pipe and cables) and $1\text{-}3/4\text{'}$ -(40mm, for drain hose) diameter holes on the wall so that it slants slightly downwards toward the outdoor for smooth water flow.

NOTE

- Use the pattern sheet to select pipe directions.

Ceiling installation (AC100/120/140/160RNC DKG)

1 Select pipe directions.

When the directions are selected, drill 3-1/8"-(100mm, for pipe and cables) and 1-3/4"-(40mm, for drain hose) diameter holes on the wall so that it slants slightly downwards toward the outdoor for smooth water flow.

NOTE

- Use the pattern sheet to select pipe directions.

2 Drill holes for anchor bolts according to the distance and mount them.

NOTE

- Use the pattern sheet.

3 Insert bolt anchors. Use existing ceiling supports or construct a suitable support as shown in figure.

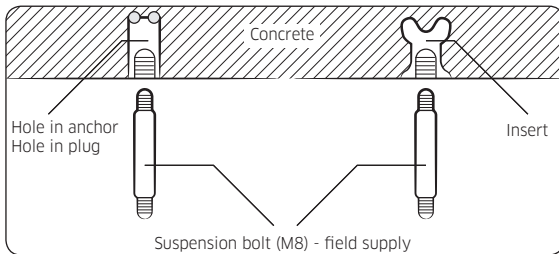

4 Install the suspension bolts depending on the ceiling type.

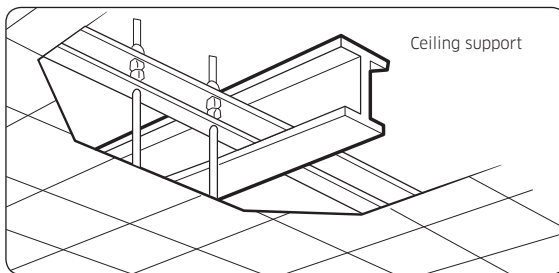

CAUTION

- Ensure that the ceiling is strong enough to support the weight of the indoor unit. Before hanging the unit, test the strength of each attached suspension bolt.
- If the length of suspension bolt is more than 1.5m, it is required to prevent vibration.
- If this is not possible, create an opening on the false ceiling in order to be able to use it to perform the required operations on the indoor unit.

5 Screw eight nuts to the suspension bolts making space for hanging the indoor unit.

NOTE

- You must install all the suspension rods.
- ### 6 When Hanging the set, firstly unscrew the screws from the both of sides, and then disassemble the Case-sides, or else the case-side will be damaged by disassembling it directly.

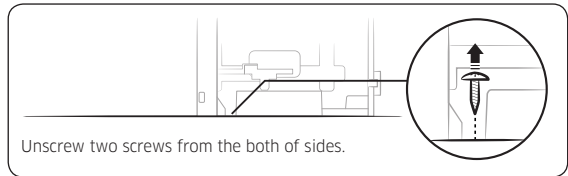

7 Reassemble the Case-sides, tightening the screws after hanging the set.

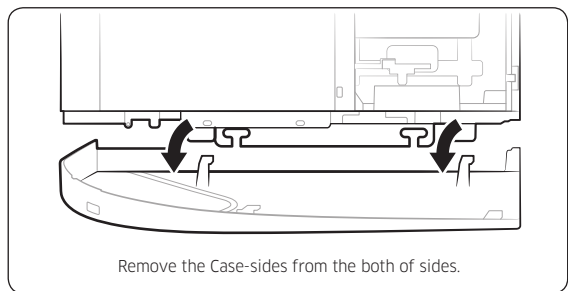

8 Hang the indoor unit to the suspension bolts between two nuts.

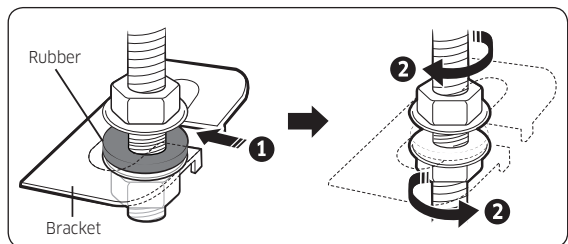

CAUTION

- Piping must be laid and connected inside the ceiling when suspending the unit. If the ceiling is already constructed, lay the piping into position for connection to the unit before placing the unit inside the ceiling.
- ### 9 Screw the nuts to suspend the unit.

Installation Procedure

10 Adjust level of the unit by using measurement plate for all 4 sides.

NOTE

- For proper drainage of condensate, give a 1° or less slant to the side of the unit which will be connected with the drain hose as shown in the figure. (The gap between the lower end of the indoor unit and the ceiling should be 12 mm or less.)

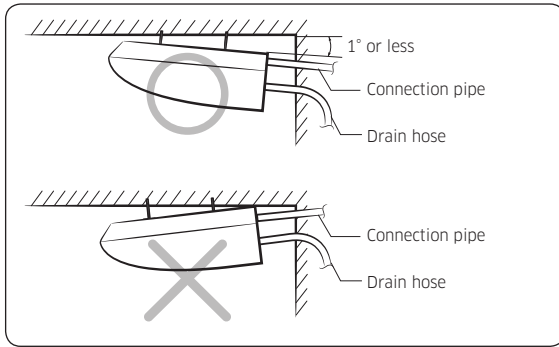

NOTE

- The gap between the lower end of the indoor unit and the ceiling should be 1° (28 mm) or less.

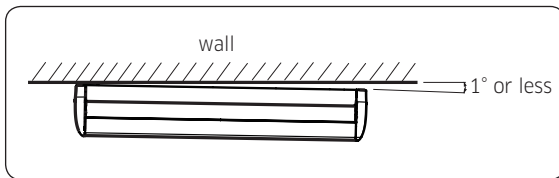

Step 4 Purging inert gas from the indoor unit

The indoor unit comes with nitrogen gas (inert gas) charged at the factory. Therefore, all inert gas must be purged before connecting the assembly piping.

Unscrew the pinch pipe at the end of each refrigerant pipe.

AC052/071RNCDKG

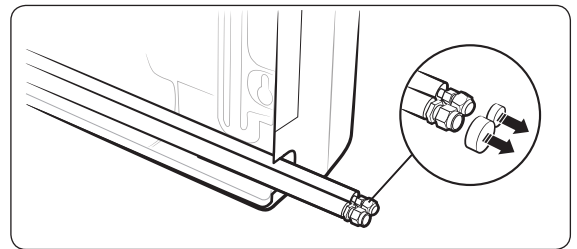

AC100/120/140RNCDKG

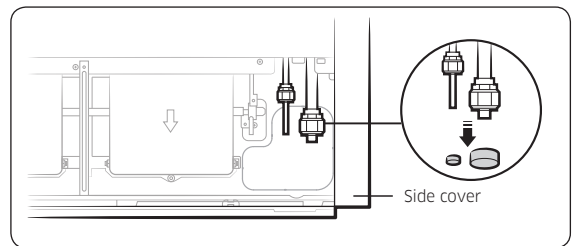

NOTE

- To prevent dirt or foreign objects from getting into the pipes during installation, do not remove the pinch pipe completely until you are ready to connect the piping.
- The designs and shape are subject to change according to the model.

Step 5 Cutting and flaring the pipes

- 1 Make sure that you have the required tools available: pipe cutter, reamer, flaring tool, and pipe holder.
- 2 If you wish to shorten the pipes, cut them with a pipe cutter, ensuring that the cut edge remains at a 90° angle to the side of the pipe. Refer to the illustrations below for examples of edges cut correctly and incorrectly.

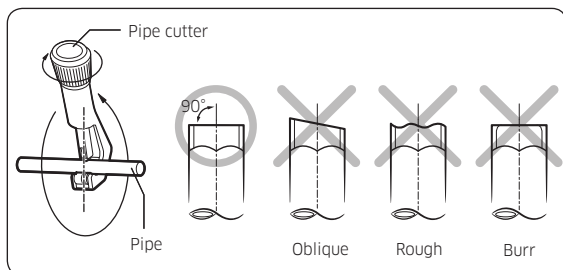

- 3 To prevent any gas from leaking out, remove all burrs at the cut edge of the pipe, using a reamer.
- 4 Slide a flare nut on to the pipe and modify the flare.

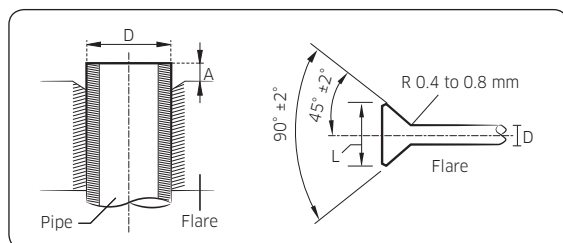

Outer Diameter (D)	Depth (A)	Flare dimension (L)
Ø6.35 mm	1.3 mm	8.7 to 9.1 mm
Ø9.52 mm	1.8 mm	12.8 to 13.2 mm
Ø12.70 mm	2.0 mm	16.2 to 16.6 mm
Ø15.88 mm	2.2 mm	19.3 to 19.7 mm
Ø19.05 mm	2.2 mm	23.6 to 24.0 mm

- 5 Check that the flaring is correct, referring to the illustrations below for examples of incorrect flaring.

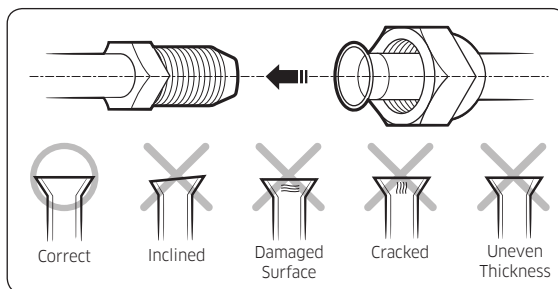

Step 6 Connecting the assembly pipes to the refrigerant pipes

There are two refrigerant pipes of different diameters :

- A smaller one for the liquid refrigerant.
- A larger one for the gas refrigerant. The inside of copper pipe must be clean and has no dust.

- 1 Remove the pinch pipe on the pipes and connect the assembly pipes to each pipe, tightening the nuts, first manually and then with a torque wrench, a spanner applying the following torque.

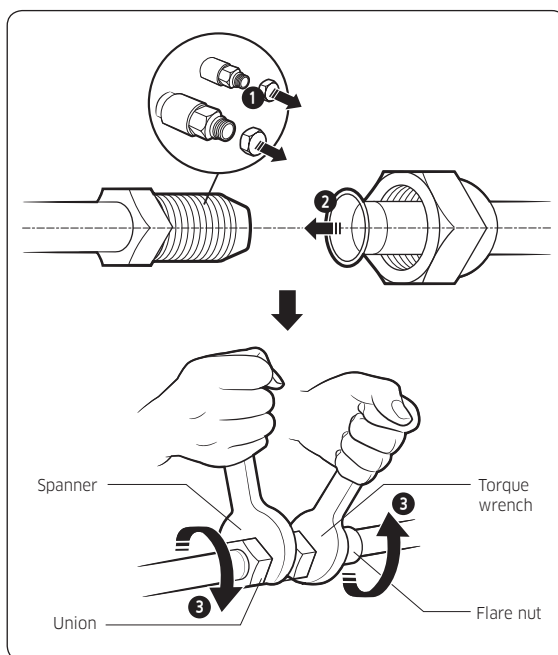

Installation Procedure

Outer diameter (mm)	Torque (N•m)
Ø6.35	14 to 18
Ø9.52	34 to 42
Ø12.70	49 to 61
Ø15.88	68 to 82
Ø19.05	100 to 120

(1 N•m=10 kgf•cm)

NOTE

- If the pipes must be shortened, see **Step 5 Cutting and flaring the pipes** on page 11.
- Tighten the nuts to the specified torques. If overtightened, the nuts could be broken so refrigerant may leak.
- 2 Be sure to use an insulator thick enough to cover the refrigerant tube to protect the condensate water on the outside of the pipe falling onto the floor and to improve the efficiency of the unit.
- 3 Cut off any excess foam insulation.
- 4 Make sure that there are no cracks or waves on the bent area.
- 5 It would be necessary to double the insulation thickness (10 mm or more) to prevent condensation even on the insulator when if the installed area is warm and humid.

CAUTION

- Connect the indoor and outdoor units using pipes with flared connections (not supplied). For the lines, use insulated, unwelded, degreased and deoxidized copper pipe (Cu DHP type to ISO 1337 or UNI EN 12735-1), suitable for operating pressures of at least 4.2 MPa and for a burst pressure of at least 20.7 MPa. Copper pipe for hydro-sanitary applications is completely unsuitable.
- For sizing and limits (height difference, line length, max. bends, refrigerant charge, etc.) see the outdoor unit installation manual.
- All refrigerant connection must be accessible, in order to permit either unit maintenance or removing it completely.
- If the pipes require brazing, make sure that oxygen free nitrogen (OFN) is flowing through the system.
- Nitrogen blowing pressure range is 0.02 to 0.05 MPa.

Step 7 Performing the gas leak test

LEAK TEST WITH NITROGEN (before opening valves)

In order to detect basic refrigerant leaks, before recreating the vacuum and recirculating the R-32, it's responsible of installer to pressurize the whole system with nitrogen (using a cylinder with pressure reducer) at a pressure above 40 bar (gauge).

LEAK TEST WITH R-32 (after opening valves)

Before opening valves, discharge all the nitrogen into the system and create vacuum. After opening valves check leaks using a leak detector for refrigerant R-32.

AC052/071RNCDBG

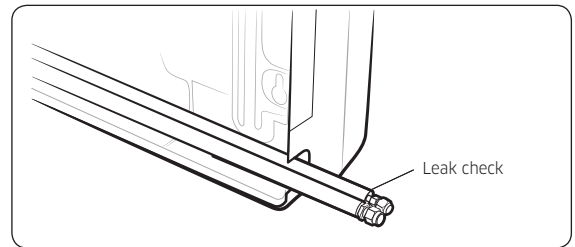

AC100/120/140RNCDBG

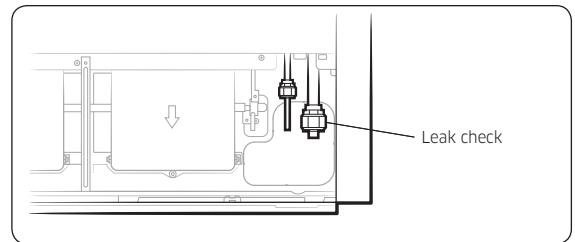

NOTE

- The designs and shape are subject to change according to the model.

Step 8 Insulating the refrigerant pipes

Once you have checked that there are no leaks in the system, you can insulate the piping and hose.

- 1 To avoid condensation problems, place Acrylonitrile Butadien Rubber separately around each refrigerant pipe.

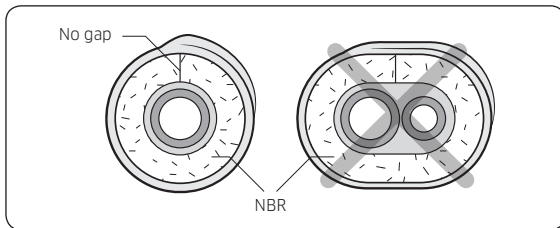

NOTE

- Always make the seam of pipes face upwards.
- 2 Wind insulating tape around the pipes and drain hose avoiding compressing the insulation too much.

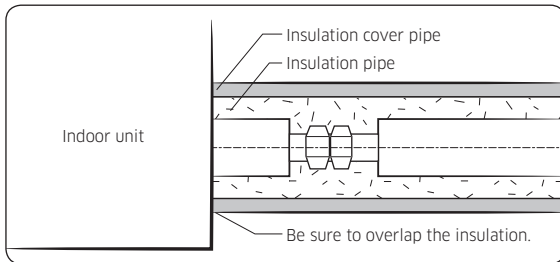

CAUTION

- Be sure to wrap insulation tightly without any gaps.
- 3 Finish wrapping insulating tape around the rest of the pipes leading to the outdoor unit.
 - 4 The pipes and electrical cables connecting the indoor unit with the outdoor unit must be fixed to the wall with suitable ducts.

CAUTION

- Make sure that all refrigerant connection must be accessible for easy maintenance and detachment.
- Install the insulation not to get wider and use the adhesives on the connection part of it to prevent moisture from entering.

- Wind the refrigerant pipe with insulation tape if it is exposed to outside sunlight.
- Install the refrigerant pipe respecting that the insulation does not get thinner on the bent part or hanger of pipe.
- Add the additional insulation if the insulation plate gets thinner.

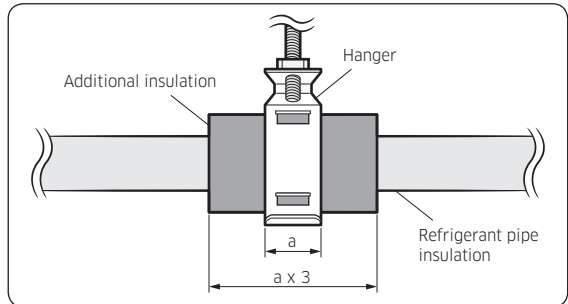

- 5 Select the insulation of the refrigerant pipe.
 - Insulate the gas side and liquid side pipe, noting the insulation thickness that must differ according to the pipe size.
 - Standard: Less than an indoor temperature of 30°C, with humidity at 85%. If installing in a high humidity environment, use one grade thicker insulator by referring to the table below. If installing in an unfavourable environment, use thicker one.
 - The heat-resistance temperature of the insulator must be more than 120°C.

Pipe	Pipe size	Insulation type (heating/cooling)		Remarks
		Standard (Less than 30°C, 85%)	High humidity (Over 30°C, 85%)	
EPDM, NBR				
Liquid pipe	Ø6.35 to Ø9.52	9t	9t	The internal temperature is higher than 120°C.
	Ø12.7 to Ø19.05	13t	13t	
Gas pipe	Ø6.35	13t	19t	
	Ø9.52	19t	25t	
	Ø12.70			
	Ø15.88			
Ø19.05				

Installation Procedure

- When installing insulation in the places and conditions below, use the same insulation that is used for high humidity conditions.

<Geological condition>
High humidity locations such as shorelines, hot springs, lake or riversides, and ridges (when part of the building is covered by earth and sand)
<Operation purpose condition>
Restaurant ceiling, sauna, swimming pool etc.
<Building construction condition>
Ceilings frequently exposed to moisture and cooling are not covered. For example, pipes installed at a corridor of a dormitory and studio or near an exit that opens and closes frequently.
Places (where the pipes are installed) that are highly humid due to a lack of ventilation.

Step 9 Installing the drain hose and drain pipe

Care must be taken when installing the drain hose for the indoor unit to ensure that any condensation water is correctly drained outside.

NOTE

- Installing the drain hose should be the shorter, the better.
 - In order to discharge condensate water, a downward gradient should be maintained.
 - Fix the drain hose with Cable-Tie, so that it will not separate from the machine.
- Insert the drain hose to bottom of the outfall of water basin.
 - Lock flexible hose clamp of the drain hose according to the figure.
 - Wind and wrap flexible hose clamp and drain hose fully with thermal insulation sponge; fix both ends of external layer with ribbon for thermal insulation.
 - After being installed, drain hose must be insulated fully by heat insulating material. (To be provided at site.)
 - Be sure to tighten the flexible hose clamp of the drain hose.
 - Wrap the insulation after attaching the flexible hose clamp.

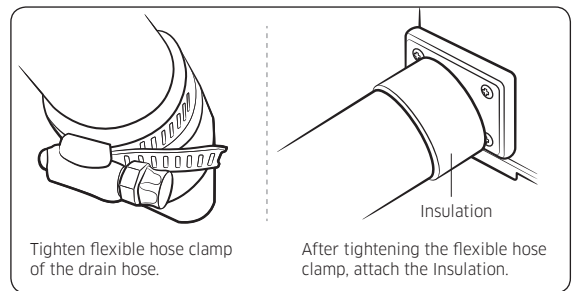
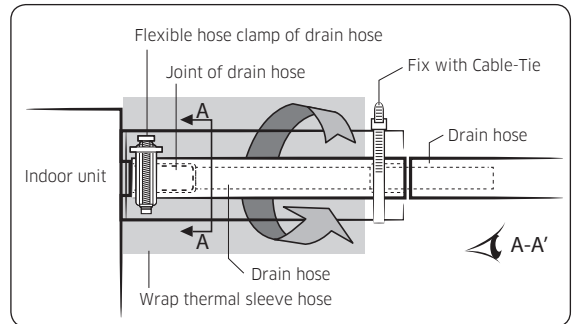

When passing the drain hose through the hole drilled in the wall, check that none of the following situations occur:

Ceiling installation

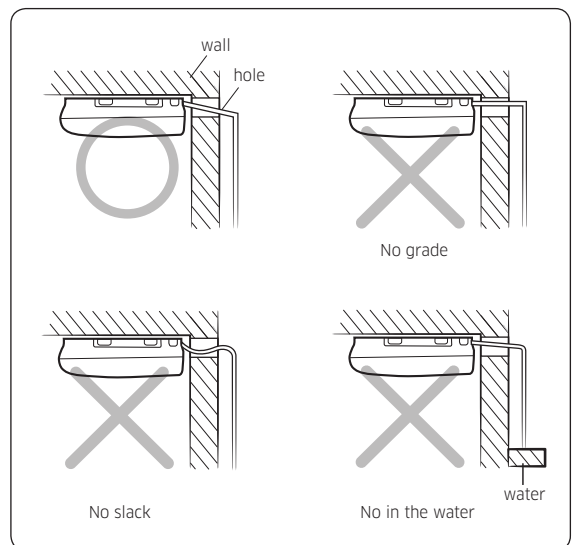

NOTE

- When the drain pipe is not long enough to use, you can extend the drain pipe by connecting an extra drain pipe, as shown in the figure:

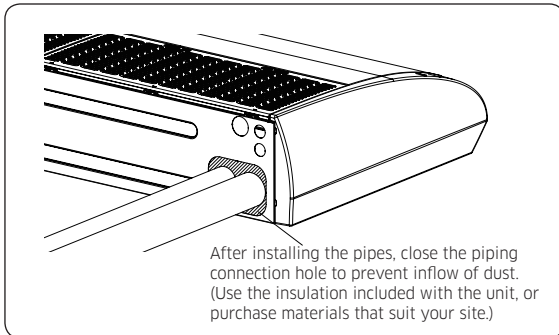
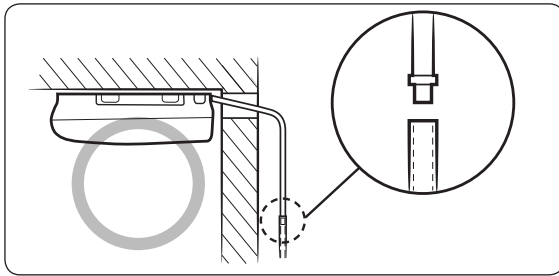

Step 10 Optional: Installing DPM

NOTE

To find DPM allowable indoor unit models according to outdoor unit models, refer to outdoor installation manual.

- When installing DPM, you should set "DPM setting" to the outdoor unit.
- You do not need to set the address manually for the indoor unit.
- If DPM model is not set, communication error may occur.
- While the outdoor unit is tracking the indoor unit for one minute after the power supply is turned on. The operation may stop if the remote control reception signal of the installed indoor unit is different.
- To enable Level control with the centralized controller, refer to page 26.

CAUTION

- When installing DPM, only one external controller can be connected.

Step 11 Optional: Installing interface module

AC100/120/140RNC DKG

Accessories (Interface module: MIM-B14)

External Control	PCB Case
Haness Wire(2P)	Haness Wire (4P)
Screw	

- Fix the case at with bolts on the side of the control box in the indoor unit.(See the picture)

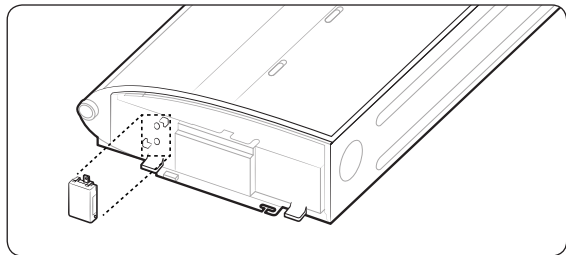

- Attach the Interface module PCB to the case in the control box of the indoor unit, then connect the power and the communication cable between the Interface module and the indoor unit;
- If you install a Interface module to an indoor unit, every outdoor unit which is connected to an indoor unit can be controlled simultaneously.
- Each indoor unit connected to the same centralized controller has its own Interface module.

Installation Procedure

Step 12 Connecting the power and communication cables

⚠ CAUTION

- Always remember to connect the refrigerant pipes before performing the electric connections. When disconnecting the system, always disconnect the electric cables before disconnecting the refrigerant pipes.

⚠ CAUTION

- Always remember to connect the air conditioner to the grounding system before performing the electric connections. Use a crimp ring terminal at the end of each wire.

The indoor unit is powered through the outdoor unit by means of a HO7 RN-F connection cable (or a more power model), with insulation in synthetic rubber and a jacket in polychloroprene (neoprene), in accordance with the requirements specified in the standard EN 60335-2-40.

- Remove the screw on the electrical component box and remove the cover plate.
- Route the connection cord through the side of the indoor unit and connect the cable to the terminals refer to the figure below.
- Route the other end of the cable to the outdoor unit through the ceiling & the hole on the wall.
- Reassemble the electrical component box cover, carefully tightening the screw.

1 phase (**052/071**)

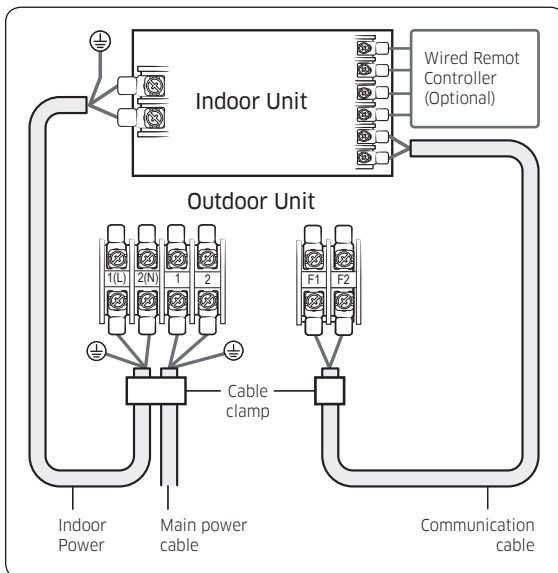

1 phase (**100/120/140**)

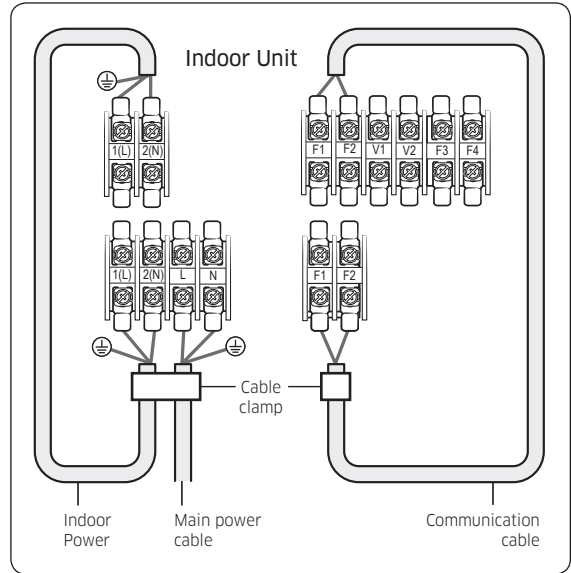

3 phase (**100/120/140**)

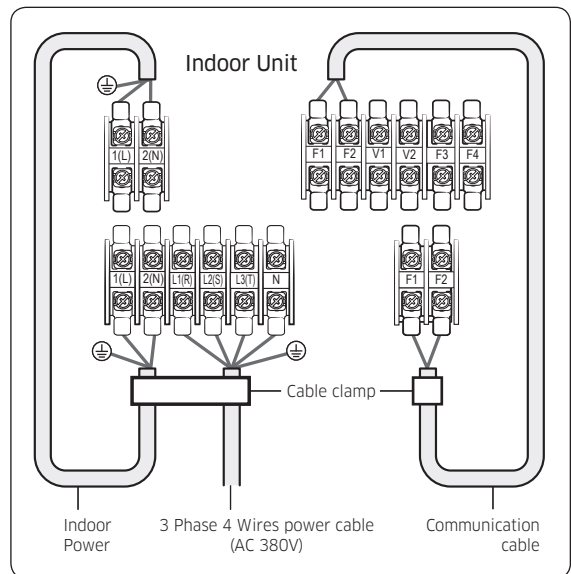

Indoor power supply		
Power supply	Max/Min(V)	Indoor power cable
220 to 240V, 50 Hz	±10%	0.75 mm ² , 3 wires
Communication cable		
0.75 mm ² , 2 wires		

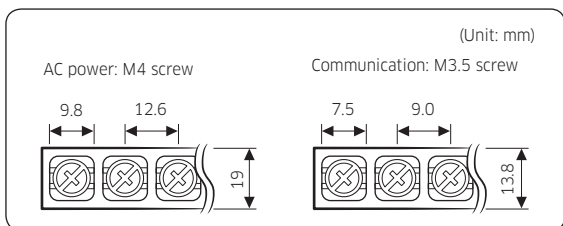

Contraction tube (mm)	70xØ8.0 (LxOD)	
-----------------------	----------------	--

2 As shown in the figure, peel off the shields from the rubber and wire of the power cable.

- Peel off 20 mm of cable shields from the pre-installed tube.

⚠ CAUTION

- For information about the power cable specifications for indoor and outdoor units, refer to the installation manual.
- After peeling off cable wires from the pre-installed tube, insert a contraction tube.
- If cable wires are connected without using connecting sleeves, their contact area becomes reduced, or corrosion develops on the outer surfaces of the wires (copper wires) over a long time. This may cause an increase of resistance (reduction of passing current) and consequently may result in a fire.

Tightening torque (kgf • cm)	
M3.5	8.0 to 12.0
M4	12.0 to 18.0

- 1 N·m = 10 kgf·cm

- Power supply cords of parts of appliances for outdoor use shall not be lighter than polychloroprene sheathed flexible cord. (Code designation IEC:60245 IEC 57 / CENELEC: H05RN-F or IEC:60245 IEC 66 / CENELEC: H07RN-F)
- Since it has the external power supply, refer to the outdoor unit installation manual for MAIN POWER.

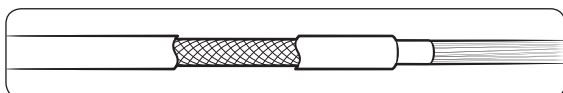

⚠ CAUTION

- When installing the indoor unit in a computer room or a server room, use the double shielded communication cable (tape aluminum / polyester braid + copper) of FROHH2R type.

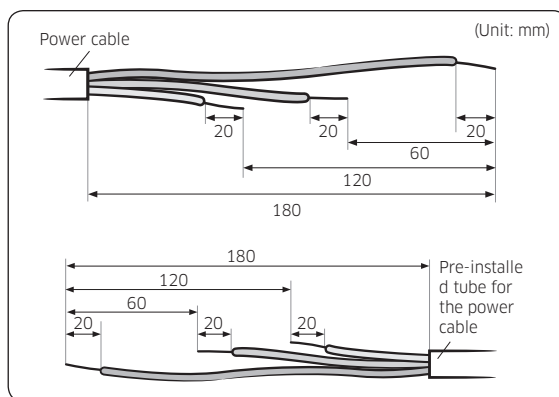

Step 13 Optional: Extending the power cable

1 Prepare the following tools.

Tools	Spec	Shape
Crimping pliers	MH-14	
Connection sleeve (mm)	20xØ6.5 (HxOD)	
Insulation tape	Width 19 mm	

3 Insert both sides of core wire of the power cable into the connection sleeve.

- **Method 1:** Push the core wire into the sleeve from both sides.
- **Method 2:** Twist the wire cores together and push it into the sleeve.

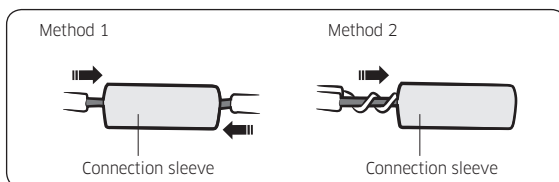

4 Using a crimping tool, compress the two points and flip it over and compress another two points in the same location.

Installation Procedure

- The compression dimension should be 8.0.

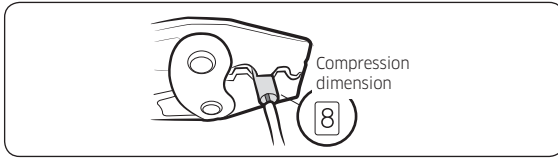

- After compressing it, pull both sides of the wire to make sure it is firmly pressed.

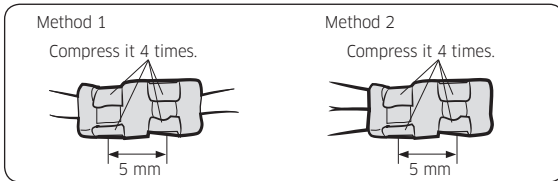

- Apply heat to the contraction tube to contract it.

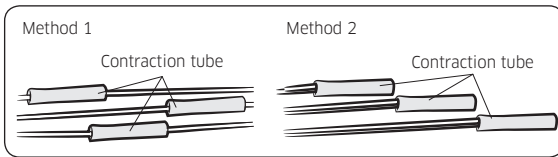

- Wrap it with the insulation tape twice or more and position your contraction tube in the middle of the insulation tape. Three or more layers of insulation are required.

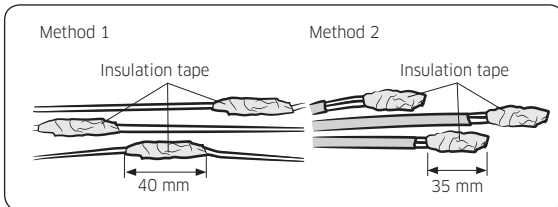

- After tube contraction work is completed, wrap it with the insulation tape to finish.

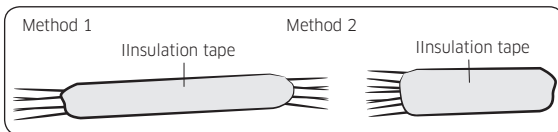

CAUTION

- Make sure that the connection parts are not exposed to outside.
- Be sure to use insulation tape and a contraction tube made of approved reinforced insulating materials that have the same level of withstand voltage with the power cable. (Comply with the local regulations on extensions.)

WARNING

- In case of extending the electric wire, please DO NOT use a round-shaped Pressing socket.
 - Incomplete wire connections can cause electric shock or a fire.

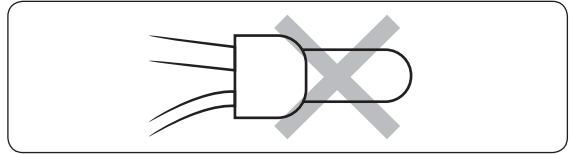

Step 14 Setting the indoor unit addresses and the installation options

- Set the indoor unit address and installation option with remote controller option. Set the each option separately since you cannot set the ADDRESS setting and indoor unit installation setting option at the same time. You need to set twice when setting indoor unit address and installation option.
- Please use the proper wireless remote controller which can set 24 digit option code.
- Please refer to the wired remote controller installation manual for setting with the wired remote controller.

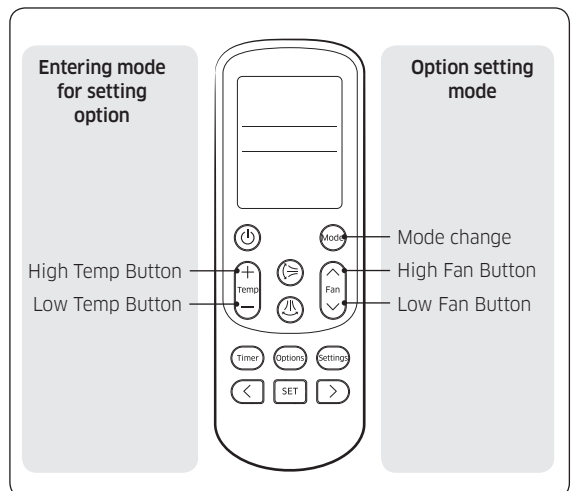

Common steps for setting the addresses and options



NOTE

The remote control display and buttons may vary depending on the model.

1 Enter the mode for setting the options:

- a Remove the batteries from the remote control, and then insert them again.
- b While holding down the  (High Temp) and  (Low Temp) buttons simultaneously, insert the batteries into the remote control.
- c Make sure that you are entered to the mode for setting the options:

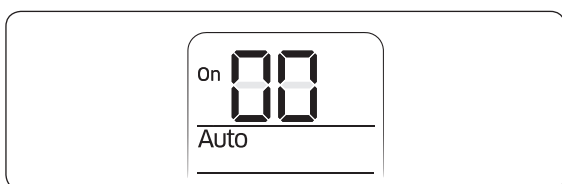

2 Set the option values.

CAUTION

- The total number of available options are 24: SEG1 to SEG24.
- Because SEG1, SEG7, SEG13, and SEG19 are the page













options used by the previous remote control models, the modes to set values for these options are skipped automatically.

- Set a 2-digit value for each option pair in the following order: SEG2 and SEG3 → SEG4 and SEG5 → SEG6 and SEG8 → SEG9 and SEG10 → SEG11 and SEG12 → SEG14 and SEG15 → SEG16 and SEG17 → SEG18 and SEG20 → SEG21 and SEG22 → SEG23 and SEG24















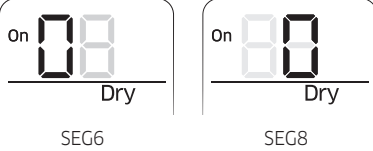

SEG1	SEG2	SEG3	SEG4	SEG5	SEG6
0	X	X	X	X	X
SEG7	SEG8	SEG9	SEG10	SEG11	SEG12
1	X	X	X	X	X
SEG13	SEG14	SEG15	SEG16	SEG17	SEG18
2	X	X	X	X	X
SEG19	SEG20	SEG21	SEG22	SEG23	SEG24
3	X	X	X	X	X

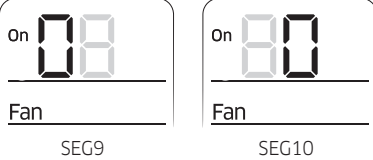
On (SEG1 to SEG12)	Off (SEG13 to SEG24)

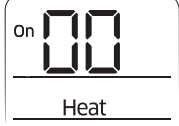

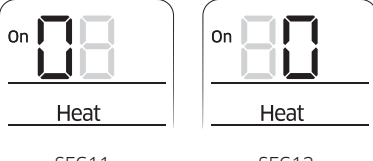



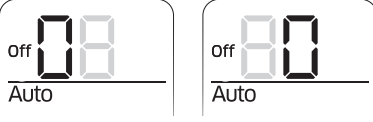











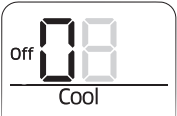
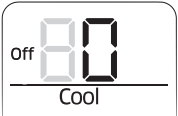







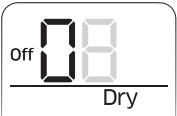
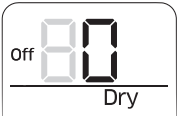

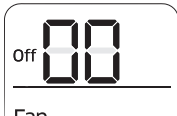





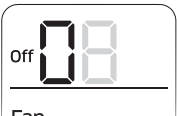

Take the steps presented in the following table:

Option setting	Status
<p>1 Setting SEG2, SEG3 option</p> <p>Press Low Fan button  to enter SEG2 value.</p> <p>Press High Fan button  to enter SEG3 value.</p> <p>Each time you press the button,  →  → ... →  →  will be selected in rotation.</p>	<p style="text-align: center;">SEG2</p> <p style="text-align: center;">SEG3</p>
<p>2 Setting Cool mode</p> <p> Press Mode button to be changed to Cool mode in the ON status.</p>	
<p>3 Setting SEG4, SEG5 option</p> <p>Press Low Fan button  to enter SEG4 value.</p> <p>Press High Fan button  to enter SEG5 value.</p> <p>Each time you press the button,  →  → ... →  →  will be selected in rotation.</p>	<p style="text-align: center;">SEG4</p> <p style="text-align: center;">SEG5</p>

Installation Procedure

Option setting	Status
<p>4 Setting Dry mode</p> <p> Press Mode button to be changed to DRY mode in the ON status.</p>	
<p>5 Setting SEG6, SEG8 option</p> <p>Press Low Fan button  to enter SEG6 value.</p> <p>Press High Fan button  to enter SEG8 value.</p> <p>Each time you press the button, 0 → 1 → ... 9 → 0 will be selected in rotation.</p>	
<p>6 Setting Fan mode</p> <p> Press Mode button to be changed to FAN mode in the ON status.</p>	
<p>7 Setting SEG9, SEG10 option</p> <p>Press Low Fan button  to enter SEG9 value.</p> <p>Press High Fan button  to enter SEG10 value.</p> <p>Each time you press the button, 0 → 1 → ... 9 → 0 will be selected in rotation.</p>	
<p>8 Setting Heat mode</p> <p> Press Mode button to be changed to HEAT mode in the ON status.</p>	
<p>9 Setting SEG11, SEG12 option</p> <p>Press Low Fan button  to enter SEG11 value.</p> <p>Press High Fan button  to enter SEG12 value.</p> <p>Each time you press the button, 0 → 1 → ... 9 → 0 will be selected in rotation.</p>	
<p>10 Setting Auto mode</p> <p> Press Mode button to be changed to AUTO mode in the OFF status.</p>	
<p>11 Setting SEG14, SEG15 option</p> <p>Press Low Fan button  to enter SEG14 value.</p> <p>Press High Fan button  to enter SEG15 value.</p> <p>Each time you press the button, 0 → 1 → ... 9 → 0 will be selected in rotation.</p>	

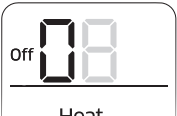
Installation Procedure

Option setting	Status
<p>12 Setting Cool mode  Press Mode button to be changed to Cool mode in the OFF status.</p>	
<p>13 Setting SEG16, SEG17 option Press Low Fan button  to enter SEG16 value. Press High Fan button  to enter SEG17 value. Each time you press the button,  →  → ... →  →  will be selected in rotation.</p>	 
<p>14 Setting Dry mode  Press Mode button to be changed to Dry mode in the OFF status.</p>	
<p>15 Setting SEG18, SEG20 option Press Low Fan button  to enter SEG18 value. Press High Fan button  to enter SEG20 value. Each time you press the button,  →  → ... →  →  will be selected in rotation.</p>	 
<p>16 Setting Fan mode  Press Mode button to be changed to Fan mode in the OFF status.</p>	
<p>17 Setting SEG21, SEG22 option Press Low Fan button  to enter SEG21 value. Press High Fan button  to enter SEG22 value. Each time you press the button,  →  → ... →  →  will be selected in rotation.</p>	 
<p>18 Setting Heat mode  Press Mode button to be changed to HEAT mode in the OFF status.</p>	
<p>19 Setting SEG23, SEG24 option Press Low Fan button  to enter SEG23 value. Press High Fan button  to enter SEG24 value. Each time you press the button,  →  → ... →  →  will be selected in rotation.</p>	 

Installation Procedure

3 Check whether the option values that you have set are correct by pressing the  button repeatedly.

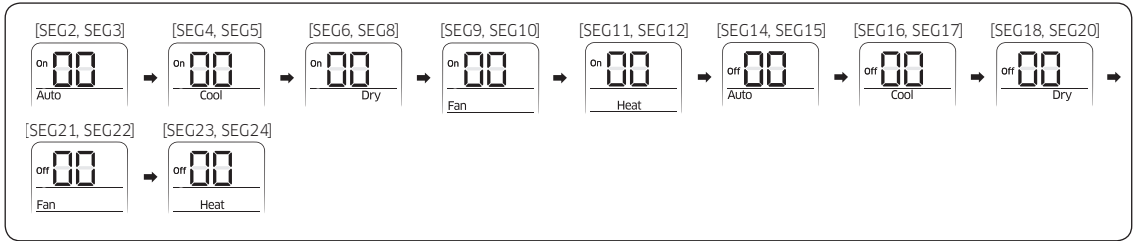

4 Save the option values into the indoor unit:

Press the  button with the direction of remote control for set. For correcting option values, input the option values twice.

5 Check whether the air conditioner operates in accordance with the option values you have set:

- a Reset the indoor unit by pressing the Reset button on the indoor or outdoor unit.
- b Remove the batteries from the remote control, insert them again, and then press the  button on the remote control.

Emergency Temperature Output (ETO) function

CAUTION

- In order to deploy the ETO function, the MIM-B14, an external contact interface module, must be installed in each indoor unit.
- The ETO is a concept of emergency operation of indoor units. If the indoor unit 1 (main indoor unit) stops because of an error, the indoor unit 2 (sub indoor unit) starts to operate.
- Basically, the indoor unit 2 operates in the previous mode. [For the first time operation, it starts in 24 °C (75 °F) Auto mode.]
- To set more detailed operation conditions for the indoor unit 2, use the S-net Pro.

Setting up the ETO

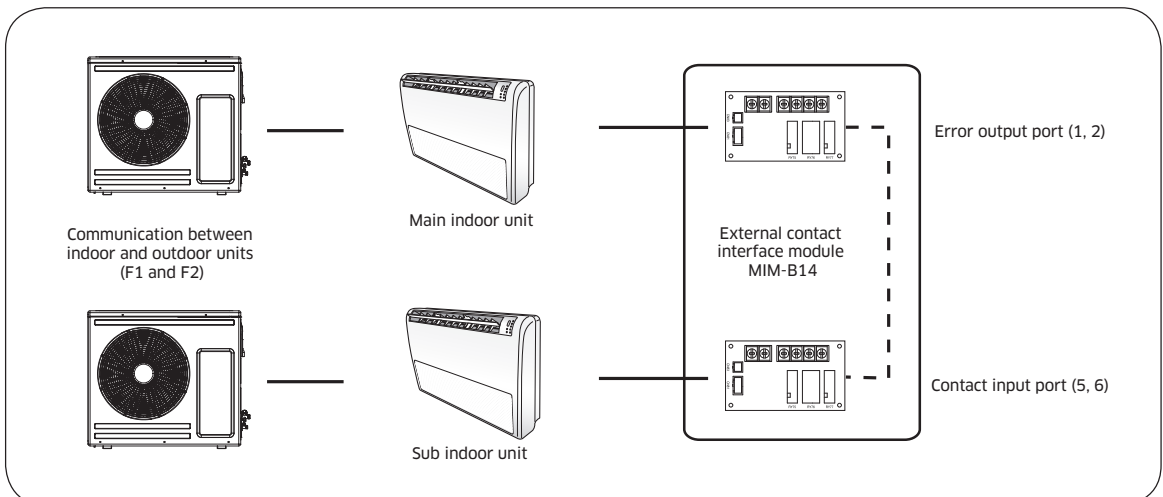

1 Main indoor unit

- Disable the external contact control (Default).
- Connect the S-net pro2 to F1 and F2.
- Enable the ETO function and set the temperature and time.

2 Sub indoor unit

- (Required) Enable the external contact control (with the installation option SEG14 - Reverse Control).
- Connect the S-net pro2 to F1 and F2.
- Enable the entrance control and set the mode, set temperature, and fan speed.

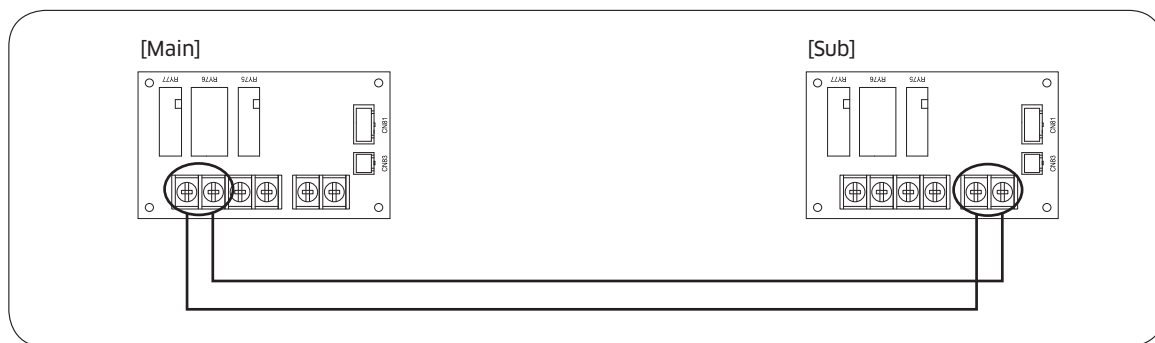

ETO operation specifications

1 Main indoor unit

- Based on the external contact control settings, the main indoor unit decides whether to generate output when an error (indoor unit stop) occurs.
- Based on the ETO settings, the main indoor unit decides whether to generate output according to the temperature and time conditions.

2 Sub indoor unit

- Based on the entrance control settings, the sub indoor unit decides the mode, set temperature, and fan speed when contact inputs are given.

	Enable of ETO	Enable of external contact	Error port output
Main indoor unit	X	X	N/A
	X	O	Output due to an error
	O	X	Output by ETO entrance conditions (temperature / time / error occurrence)
	O	O	Output by ETO entrance conditions (temperature / time / error occurrence) * Ready to control the main contact input

	Enable of entrance control	Enable of external contact	Operation when outputting Main
Sub indoor unit	X	X	N/A
	X	O	On with the previous operation conditions
	O	O	On with the entrance control enabled

Installation Procedure

Setting the indoor unit addresses

Option No. for an indoor unit address: 0AXXXX-1XXXXX-2XXXXX-3XXXXX

Before installing an indoor unit, be sure to set an address for the indoor unit by taking the following steps:

- 1 Make sure that the power is supplied to the indoor unit. If the indoor unit is not plugged in, it must include a power supply.

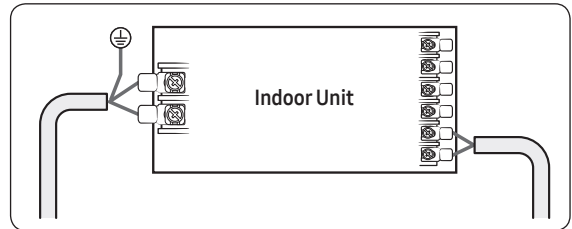

- 2 Set an address for each indoor unit using the remote control, according to your air conditioning system plan, by referring to the following table and by following the steps in **Common steps for setting the addresses and options** on page 17.
 - The indoor unit addresses (main and RMC addresses) are set to 0A0000-100000-200000-300000 by default.
 - If indoor units and outdoor units match 1:1, you don't need to set the main address because it is automatically set by the outdoor unit.
 - If you are using on or off controller, set RMC address.

Option	SEG1		SEG2		SEG3		SEG4	SEG5		SEG6			
Function	Page		Mode		Setting main address		Reserved	Indoor unit number		Indoor unit number			
Indication and details	Indication	Details	Indication	Details	Indication	Details		Indication	Details	Indication	Details		
	0		A		0	No main address		0 to 1	Tens digit	0 to 9	Units digit		
				1	Main address setting mode								
Option	SEG7		SEG8		SEG9		SEG10	SEG11		SEG12			
Function	Page		Reserved		Setting RMC address		Reserved	Group channel (x16)		Group address			
Indication and details	Indication	Details			Indication	Details		Indication	Details	Indication	Details	Indication	Details
	1				0	No RMC address		RMC1	0 to 2	RMC2	0 to F		
			1	RMC address setting mode									

⚠ CAUTION

- The main address must be set to a value in the range 0 to 15. If you set other values, communication error will occur.
- If any of SEG5 and SEG6 is set to a value in the range A to F, the main address of the indoor unit does not change.
- If SEG3 is set to 0, the indoor unit maintains the existing main address even if SEG6 is set to a new value.
- If SEG9 is set 0, the indoor unit maintains the existing RMC address even if SEG11 and SET12 are set to new values.

Setting an indoor unit installation option (suitable for the condition of each installation location)

- 1 Make sure that the power is supplied to the indoor unit. If the indoor unit is not plugged in, it must include a power supply.
- 2 The panel(display) should be connected to an indoor unit to receive option.
- 3 Set the installation option according to the installation condition of an air conditioner.
 - The default setting of an indoor unit installation option is “02000-100000-200000-300000”.
 - Individual control of a remote controller(SEG20) is the function that controls an indoor unit individually when there is more than one indoor unit.
 - No need to assign SEG3, 6, 8, 9, 10, 11, 14, 22, 23, 24 which are non applicable. Even though those segments are set, they will be ignored.
 - If you set the applicable segments with numbers other than the indicated, the initial setting will be maintained.
- 4 Set the indoor unit option by wireless remote controller.

Option No. : 02XXXX-1XXXXX-2XXXXX-3XXXXX

Option	SEG1		SEG2		SEG3		SEG4		SEG5		SEG6	
Explanation	PAGE		MODE		RESERVED		Use of external temperature sensor		Use of central control		RESERVED	
Indication and Details	Indication	Details	Indication	Details			Indication	Details	Indication	Details		
	0		2				0	Disuse	0	Disuse		
					1	Use	1	Use				
Option	SEG7		SEG8		SEG9		SEG10		SEG11		SEG12	
Explanation	PAGE		RESERVED		RESERVED		RESERVED		RESERVED		RESERVED	
Indication and Details	Indication	Details										
Option	SEG13		SEG14		SEG15		SEG16		SEG17		SEG18	
Explanation	PAGE		Use of external control		Setting the output of external control		RESERVED		Buzzer control		Number of hours using filter	
Indication and Details	Indication	Details	Indication	Details	Indication	Details			Indication	Details	Indication	Details
	2		0	Disuse	Sub, Existing Control	0			Thermo on	0	Use of buzzer	2
		1	On/Off									
		2	Off									
		3	Window									
		4	Disuse									
		5	On/Off									
		6	Off	Main, Existing Control	1	Operation on	1	Non use of buzzer	6	2000 Hour		
	7	Window										
	8	Disuse										
	9	On/Off										
	A	Off										
	B	Window										
		C	Disuse	Main, Reverse Control								
	D	On/Off										
E	Off											
F	Window											

Installation Procedure

CAUTION

- SEG18 is applied in case of strong wind.

Option	SEG19		SEG20		SEG21		SEG22	SEG23	SEG24
Explanation	PAGE		Individual control of a remote controller		Heating setting compensation		RESERVED	RESERVED	RESERVED
Indication and Details	Indication	Details	Indication	Details	Indication	Details			
	3		0 or 1	Indoor 1	0	Default			
			1	2 °C	2	5 °C			
			2	Indoor 2					
			3	Indoor 3					
4	Indoor 4								

- If you input a number other than 0~4 on the individual control of the indoor unit(SEG 20), the indoor is set as "Indoor 1".
Example) If you want to set as "Exterior temperature sensor : USE, External control : USE, Number of hours using filter : 2000hr",

SEG1	SEG2	SEG3	SEG4	SEG5	SEG6
0	2	-	1	0	-
SEG7	SEG8	SEG9	SEG10	SEG11	SEG12
1	-	-	-	-	0
SEG13	SEG14	SEG15	SEG16	SEG17	SEG18
2	-	0	-	0	6
SEG19	SEG20	SEG21	SEG22	SEG23	SEG24
3	0	0	-	-	-

assign option codes except SEG 1, 7,13,19 which are page options.

- * Level control: The centralized controller can limit the functions and inputs of connected products with this function enabled. Example: Operation mode limit (Cooling only/Heating only/No limitation), Heating temperature upper limit, Cooling temperature lower limit) To enable 'Level control' when applying the DPM with the centralized controller, appoint the Main (Set 'Use of external control [SEG14] option to 4 or higher).

Example: When installing DPM (1 Outdoor unit with 4 indoor units)

Condition		SEG14 Setting				Result
External control	Level control	Indoor 1	Indoor 2	Indoor 3	Indoor 4	
Default		Not set (0)				Sub (All)
Disuse	Use	4	Not set (0)	Not set (0)	Not set (0)	Main (Indoor 1), Sub (Indoor 2,3,4)
Use (Indoor 3)	Disuse	Not set (0)	Not set (0)	1~3	Not set (0)	Sub (All)
Use (Indoor 4)	Use	Not set (0)	Not set (0)	Not set (0)	5~7	Main (Indoor 4), Sub (Indoor 1,2,3)

Changing a particular option

You can change each digit of set option.

Option	SEG1		SEG2		SEG3		SEG4		SEG5		SEG6	
Explanation	PAGE		MODE		The option mode you want to change		The tens' digit of an option SEG you will change		The unit digit of an option SEG you will change		The changed value	
Indication and Details	Indication	Details	Indication	Details	Indication	Details	Indication	Details	Indication	Details	Indication	Details
		0		D		Option mode	0~F	Tens' digit of SEG	0~9	Unit digit of SEG	0~9	The changed value

NOTE

- When changing a digit of an indoor unit address setting option, set the SEG3 as 'A'.
- When changing a digit of indoor unit installation option, set the SEG3 as '2'.
Ex) When setting the 'buzzer control' into disuse status.





Option	SEG1	SEG2	SEG3	SEG4	SEG5	SEG6
Explanation	PAGE	MODE	The option mode you want to change	The tens' digit of an option SEG you will change	The unit digit of an option SEG you will change	The changed value
Indication	0	D	2	1	7	1

Troubleshooting

- If an error occurs during the operation, one or more LED flickers and the operation is stopped except the LED.
- If you re-operate the air conditioner, it operates normally at first, then detect an error again.

LED Display on the indoor unit

AC052/071RNC DKG

Abnormal conditions	Indicators					Remarks
						
Power reset	●	X	X	X	X	
Error of temperature sensor in indoor unit (OPEN/SHORT)	X	●	X	X	X	Displayed on appropriate indoor unit which is operating
Error of the indoor unit pipe sensor	●	●	X	X	X	Displayed on appropriate indoor unit which is operating
Error of the outdoor unit pipe sensor	●	X	●	X	X	Displayed on appropriate indoor unit which is operating Displayed on outdoor unit
Communication error (Transmitter, wired remote control)	X	●	●	X	X	Error of indoor unit: Displayed on the indoor unit regardless of operation
Communication error between indoor units	●	X	X	●	X	Error of outdoor unit: Displayed on the indoor unit which is operating
Error of peripherals option set-up	X	●	X	●	X	
EEPROM error	●	●	●	●	●	
EEPROM option error	●	●	●	●	●	
High pressure blockage error (Refrigerant completely Leakage error)	●	X	●	●	X	
Error of outdoor Unit/Self-Diagnosis(Check error code in outdoor unit or solution display or thermal fuse on Indoor's POWER T/B(open))	X	●	●	●	X	

● : On, ● : Blinking, X : Off

- If you turn off the air conditioner when the LED is flickering, the LED is also turned off.
- If you re-operate the air conditioner, it operates normally at first, then detects an error again.

AC100/120/140RNCDKG

Abnormal conditions	Indicators				Remarks
	Blue	Green	Orange	Red	
Power reset	◐	X	X	X	0.5[S]=On, 0.5[S]=Off
Operation on	●	X	X	X	
Operation off	X	X	X	X	
Reservation	X	●	X	X	
Filter sign	X	X	●	X	
Defrosting	◐	X	X	X	1[S]=On, 9[S]=Off
Smart install Error	X	X	X	●	
Communication error between indoor units and outdoor unit	X	◐	X	X	
EEPROM error /EEPROM option error	◐	X	X	◐	
Error of temperature sensor in indoor unit (open/short)	X	X	X	◐	
Error of outdoor Unit/Self-Diagnosis	X	X	◐	X	
Error of the indoor unit pipe sensor	X	◐	X	◐	
Indoor fan error	◐	◐	X	X	
Thermal fuse open error	◐	X	◐	X	
Indoor unit float S/W 2nd detection	X	◐	◐	X	

● : On, ◐ : Blinking, X : Off

- If you turn off the air conditioner when the LED is flickering, the LED is also turned off.
- If you re-operate the air conditioner, it operates normally at first, then detects an error again.
- If the LED displays only one color, it is turned on for a second and turned off for a second.
- If the LED displays more than two colors, each color is shown for a second alternately.

Troubleshooting

Wired remote control

- If an error occurs,  is displayed on the wired remote control.
- If you would like to see an error code, press the Test button.

Display	Explanation
E108	Error due to repeated communication address
E121	Error on room temperature sensor of indoor unit (Short or Open)
E122	Error on EVA IN sensor of indoor unit (Short or Open)
E123	Error on EVA OUT sensor of indoor unit (Short or Open)
E153	Error on float switch (2nd detection)
E154	Indoor fan error
E198	Error on thermal fuse of indoor unit (Open)
E201	Communication error between indoor unit and outdoor unit (Pre tracking failure or when actual number of indoor units are different from the indoor unit quantity setting on the outdoor unit) Error due to communication tracking failure after initial power is supplied.
E202	Communication error between indoor unit and outdoor unit (When there is no response from indoor units after tracking is completed)
E203	Communication error between outdoor unit inv - main micom (For PF #4~#6 controller, error will be determined from the time when compressor is turned on)
E221	Error on outdoor temperature sensor (Short or Open)
E231	Error on outdoor COND OUT sensor (Short or Open)
E251	Error on discharge temperature sensor of compressor 1 (Short or Open)
E320	Error on OLP sensor (Short or Open)
E403	Compressor down due to freeze protection control
E404	System stop due to overload protection control
E416	System stop due to discharge temperature
E422	Blockage detected on high pressure pipe
E425	Reverse phase or open phase
E440	Heating operation restricted at outdoor temperature over Theat_high value (default: 30 °C)
E441	Cooling operation restricted at outdoor temperature below Tcool_low value (default: 0 °C)
E458	Fan speed error

Display	Explanation
E461	Error due to operation failure of inverter compressor
E462	System stop due to full current control
E463	Over current trip / PFC over current error
E464	IPM Over Current(O.C)
E465	Comp. Over load error
E466	DC-Link voltage under/over error
E467	Error due to abnormal rotation of the compressor or unconnected wire of compressor
E468	Error on current sensor (Short or Open)
E469	Error on DC-Link voltage sensor (Short or Open)
E470	Outdoor unit EEPROM Read/Write error (Option)
E471	Outdoor unit EEPROM Read/Write error (H/W)
E472	AC Line Zero Cross Signal out
E473	Comp Lock error
E474	Error on IPM Heat Sink sensor of inverter 1 (Short or Open)
E475	Error on inverter fan 2
E484	PFC Overload (Over current) Error
E485	Error on input current sensor of inverter 1 (Short or Open)
E500	IPM over heat error on inverter 1
E508	Smart install is not installed
E554	Gas leak detected
E556	Error due to mismatching capacity of indoor and outdoor unit
E557	DPM remote controller option error
E590	Inverter EEPROM CheckSum error
E660	Inverter Boot Code error



This appliance is filled with R-32.