

Air to Water Heat Pump

Installation manual

Wired remote controller MWR-WW10N

- Thank you for purchasing this Samsung Product.
- Before operating this unit, please read this installation manual carefully and retain it for future reference.



SAMSUNG

Contents

Safety Information	3
<hr/>	
Safety Information	3
Wired Remote Controller Installation	4
<hr/>	
Wired Remote Controller Installation	4
External Dimensions	4
Wired Remote Controller Installation	5
Tracking Your Indoor Unit from the Wired Remote Controller [See the image A]	8
Individual control with your wired remote controller	9
Group control with your wired remote controller	10
Controlling 2-remote controller	11
Sharing the temperature of hot water tank sensor	12
Initializing Your Wired Remote Controller Communication	14
Errors displayed on the Wired Remote Controller	14
Installation/ Service mode	15
<hr/>	
Installation/ Service mode	15
Additional functions of the Wired Remote Controller [See the image B]	15
Installation/ Service mode	16
The example of Wired Remote Controller option setting method	21
How to download to microSD Card	21
Self-test mode of wired remote controller	23
Use of self-test mode [See the image D]	23

The lowest set temperature is limited to 20 degree in the UAE according to UAE.S 50 10-5:2016.

Safety Information

This installation manual explains how to install a Wired Remote Controller connected to the indoor unit of your Samsung system air conditioner. Please read this manual thoroughly before installing the product. (Please refer to appropriate installation for any optional product installation.)

WARNING

Hazards or unsafe practices that may result in severe personal injury or death.

CAUTION

Hazards or unsafe practices that may result minor personal injury or property damage.

WARNING

Contact a service centre for installation.

- Potential risk of malfunction, water leak, electric shock and fire.

Install the product on a hard and even place that can support its weight.

- If the place cannot support its weight, the product may fall down and it may cause product damage.

Install the product with proper power supply.

- Potential risk of fire or product damage.

Do not move or reinstall the product on your discretion.

- Potential risk of electric shock or fire.

Consult the place of purchase or a contact centre to disassemble or repair the product.

- Potential risk of malfunction, electric shock, or fire.

Check if the installation work is done correctly according to the installation manual.

- Incorrect installation may cause electric shock or fire.

The electric work must be done by qualified person according to national wiring regulations and installation guide.

- If an unauthorized person performs the installation, any resulting defects can cause malfunctions, electrical shocks, or fire accidents.

When you want to dispose your Wired Remote Controller, ask the service centre.

CAUTION

Do not install the product where there's combustible gas.

- Potential risk of fire and explosion.

Do not install the product in areas exposed to oil or vapor.

- Potential risk of product damage or malfunction.

Ensure no water gets into the Wired Remote Controller.

- Potential risk of electric shock or fire.

Do not put undue stress on the power cable.

- Potential risk of broken cable and fire.

Install the air conditioner away from direct exposure to sunlight, in room temperature range of 0 °C(32 °F)~39 °C(102 °F).

- Potential risk of electric shock or malfunction.

Do not install the product in areas with frequent use of acid or alkali spray.

- Potential risk of electric shock or product malfunction.

Do not handle the product with sharp objects.

- Potential risk of electric shock or product damage.

Do not connect power cable to a communication terminal.

- Potential risk of fire.

Be cautious not to interfere any other electrical devices if the product is installed in a place such as hospital.

- Potential risk of product malfunction.

Wired Remote Controller Installation

External Dimensions

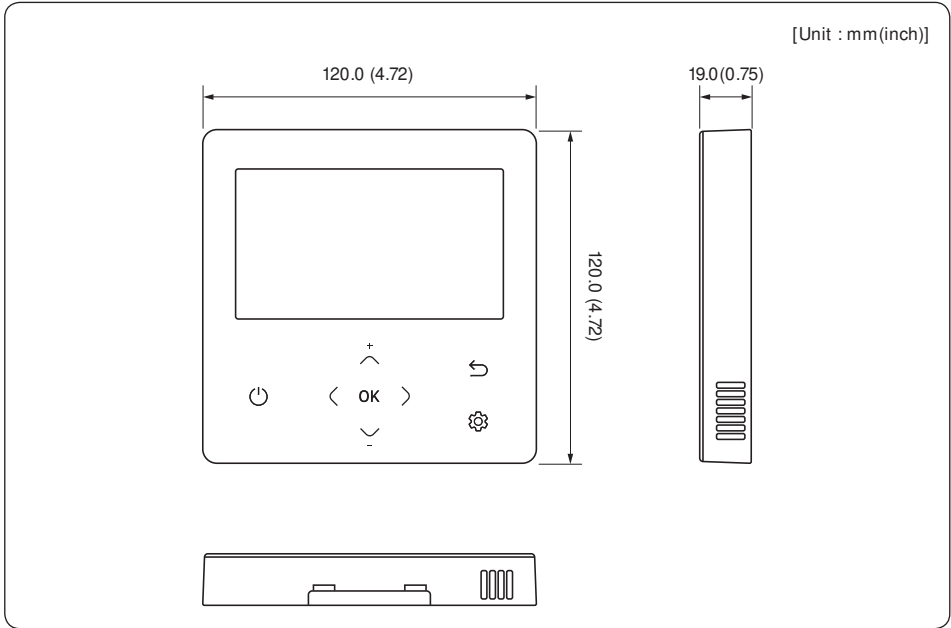

Wired Remote Controller Installation

Wired Remote Controller Installation

- 1 Insert the flat-head screwdriver into two square grooves at the bottom of the Wired Remote Controller and rotate it to lift the front cover for removal from the rear cover.

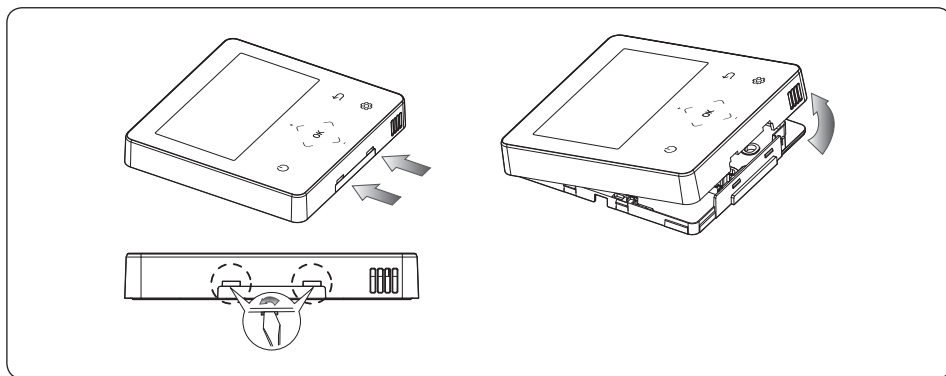

- 2 Arrange the power cable and the communication cable so that they fit in the housing along the edges of the rear cover.

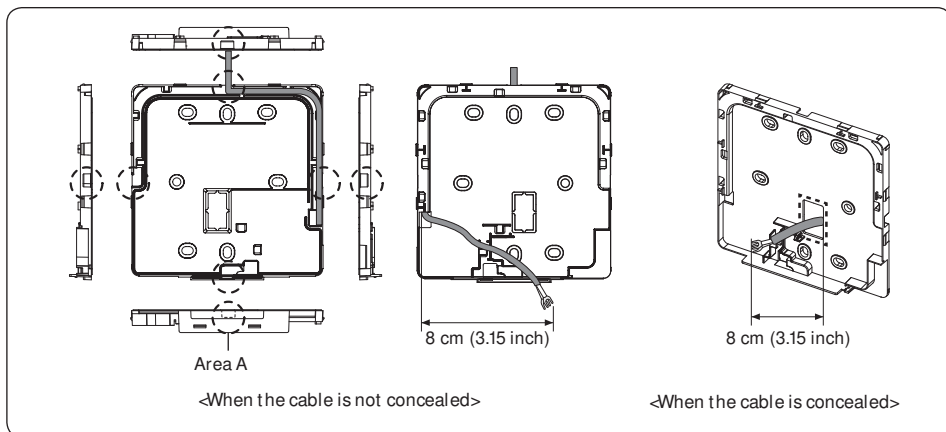

NOTE

- When connecting the power and communication cables to the bottom of the Wired Remote Controller, first cut off the area A.

Wired Remote Controller Installation

- Using two or more screws, firmly affix the rear cover of the remote controller to the wall, and then cut off the grooves of the front covers for communication and power cables, making sure these cables have reasonable length.

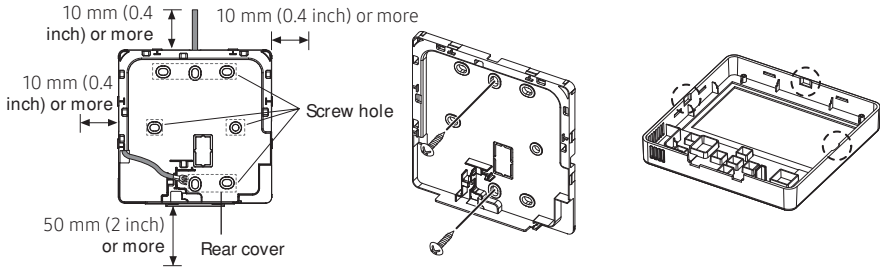

※ Before fixing the rear cover, secure at least 10 mm (0.4 inch) space of upper side, left side, right side, and 50 mm (2 inch) space of bottom side.

※ You must fit the screws into the screw holes.

- Connect the communication cables (F3, F4) to the terminals of the back of the front cover, and then fix the wires so that they do not get stuck during connection.

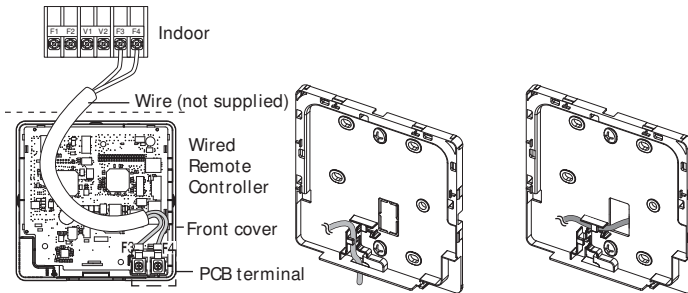

※ Do not tighten the screws on the PCB terminal with excessive force.

⚠ CAUTION

- When using an electric screwdriver, tighten the screws to the standard torque because the top of screws may be worn out if you use a strong torque.

5 Reassemble the Wired Remote Controller.

 NOTE

- Align the controller with the upper groove first, and then insert it by turning it downwards as shown in the figure. After assembly, check and confirm that no wires are stuck in the gap between the back and front covers.

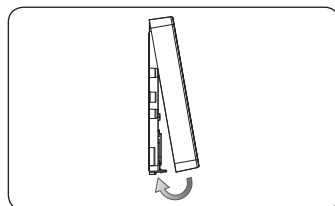

6 Remove the front protective film.

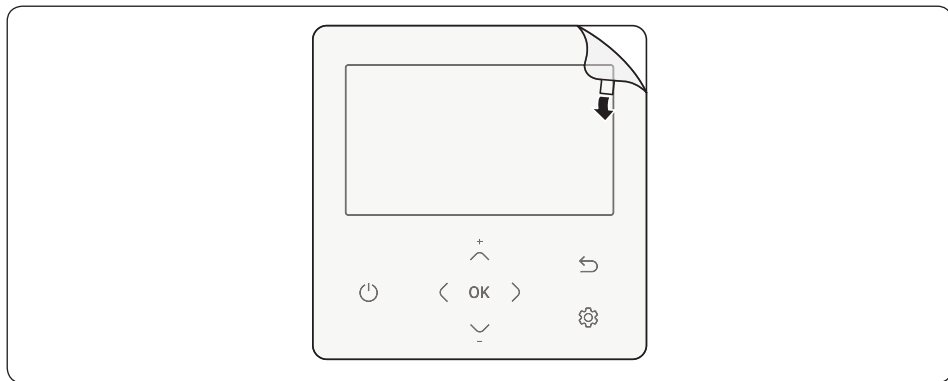

 CAUTION

- When installing a Wired Remote Controller by using a cable longer than 10 m (32.80 ft), you must install the communication cable and the power cable separately. (Electrical interference can cause the Wired Remote Controller to malfunction.)
- When installing your Wired Remote Controller on the wall, consider the size of the wire hole, and select a wire with a proper thickness.
- Wire that is connectable to Wired Remote Controller PCB.
 - If you install the Wired Remote Controller by reclaiming, install it according to U-terminal cable specification.
 - If you install the Wired Remote Controller by using two pieces of PVC wire, remove the 30 cm (12 inch) of the sheath of the cable and install it only with the two pieces of wires. (Recommended specification: AWG20)

Wired Remote Controller Installation

- The following are the specs of the compression ring terminal connected to your Wired Remote Controller PCB.

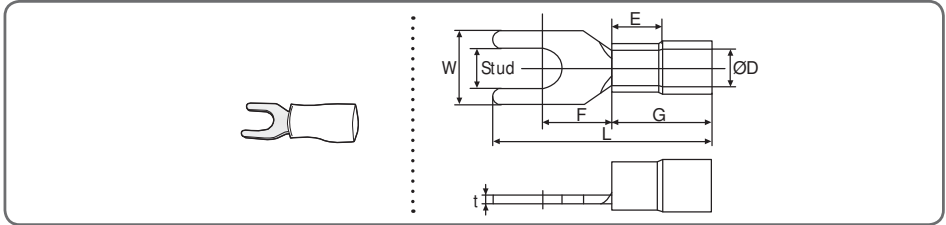

Range of Permitted Wires		Rated Size	Stud Size	Basic Size [mm (inch)]						
AWG	mm ² (inch ²)	mm ² (inch ²)	mm (inch)	t	ØD	G	E	F	W	L
22~16	0.25~1.65 (0.0003 ~ 0.0025)	1.5 (0.0023)	3 (0.1181)	0.7 (0.0275)	3.8 (0.1496)	10.0 (0.3937)	4.5 (0.1771)	6.5 (0.2559)	6.0 (0.2362)	21.2 (0.8346)

※ Maximum distance for connecting communication and power cable: 100 m (328 ft)

- Screws on the PCB terminal must be tightened with less than 6N-cm tightening torque. If the tightening torque is greater, it may damage the screw thread.

Tracking Your Indoor Unit from the Wired Remote Controller [See the image [A](#)]

- Tracking of your Wired Remote Controller will automatically start when you turn on the power after installation.
- If you want to perform tracking again after installation, then press the and buttons at the same time for more than 5 seconds.
 - The system will reset, and tracking will start again.
- During tracking, the total number of currently searched indoor units will be displayed.
- It may take about 5 minutes at initial installation or when you re-set the Master setting.

NOTE

- The operation displays on the remote controller may differ depending on the selected language.
- If you want to perform tracking again after installation, then press the and buttons at the same time for more than 5 seconds.

Individual control with your wired remote controller

Individual control means that you are using one remote controller to control one indoor unit or one DVM Hydro unit/Hydro unit HT

When connecting the Tank integrated Hydro Unit

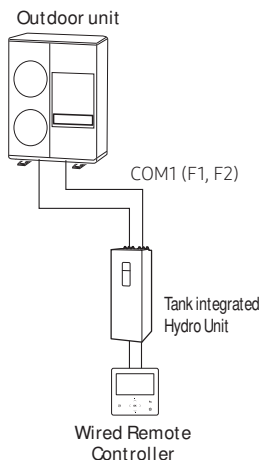

When connecting the DVM Hydro unit/ Hydro unit HT only

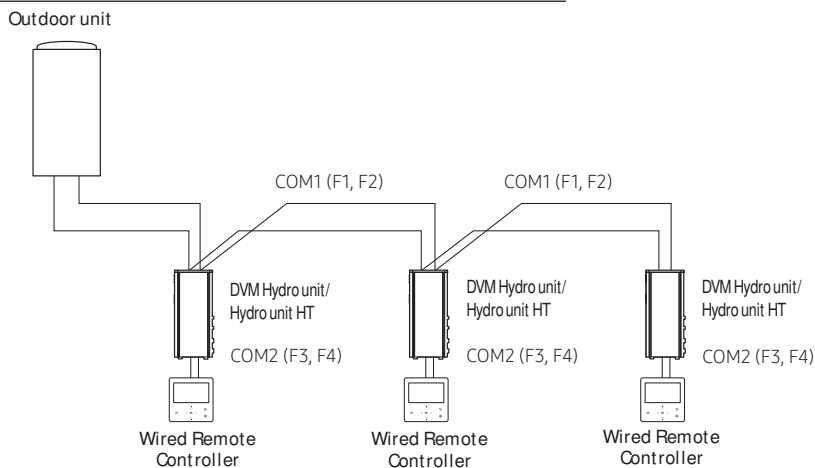

CAUTION

- Regardless of the DVM Hydro unit/Hydro unit HT group address (RMC address) setting, only the DVM Hydro unit/ Hydro unit HT connected to COM2 is individually controlled.

Wired Remote Controller Installation

Group control with your wired remote controller

Group control means that you are using one wired remote controller to control two or more DVM Hydro unit/Hydro unit HTs at the same time.

When connecting the DVM Hydro unit/ Hydro unit HT only

- 1 Using one wired remote controller to control three DVM Hydro unit/Hydro unit HTs

Outdoor unit

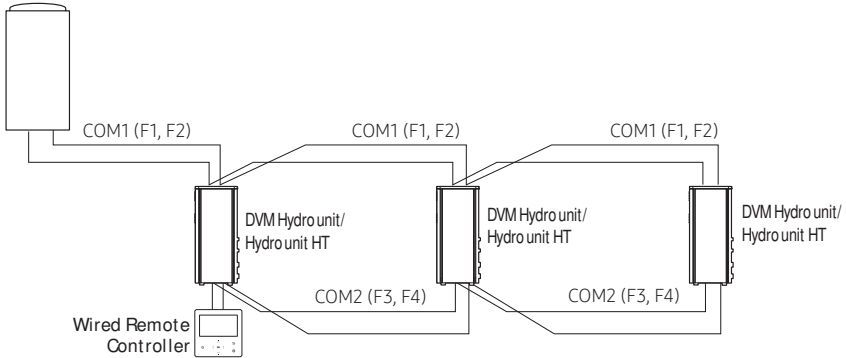

- 2 Using one wired remote controller to control DVM Hydro unit/Hydro unit HTs connected to different outdoor unit

Outdoor unit

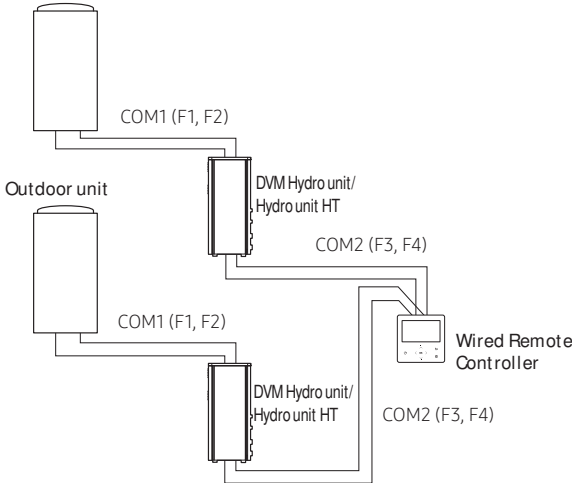

⚠ CAUTION

- Regardless of the DVM Hydro unit/Hydro unit HT group address (RMC address), only the DVM Hydro unit/Hydro unit HTs connected to COM2 are controlled in group.
- Regardless of your outdoor units, you can control a maximum of 16 DVM Hydro unit/Hydro unit HTs as a group.

Controlling 2-remote controller

2-Remote controller is controlling one DVM Hydro unit/Hydro unit HT with two remote controllers.

When setting the wired remote controller as 'Indoor temperature standard/wired remote controller sensor use', please install the master remote controller at indoor places.

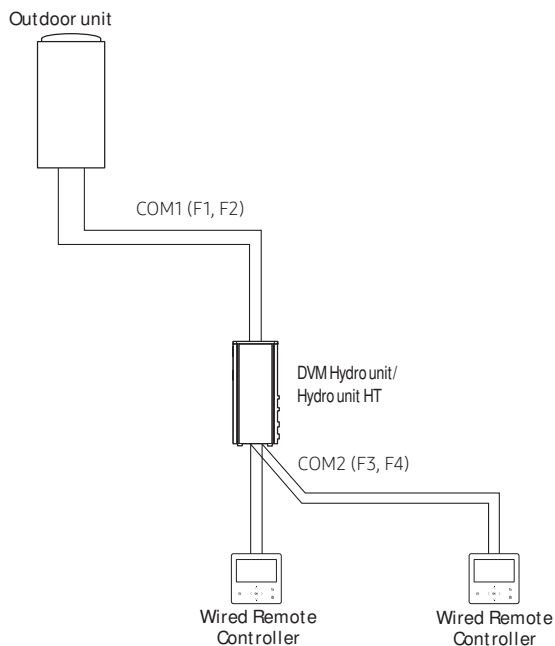

CAUTION

- For the slave wired remote controller settings, please refer to the sections about the wired remote controller installation/service mode. (Refer to page16) 0: Master, 1: Slave

Wired Remote Controller Installation

Sharing the temperature of hot water tank sensor

Connecting one wired remote controller

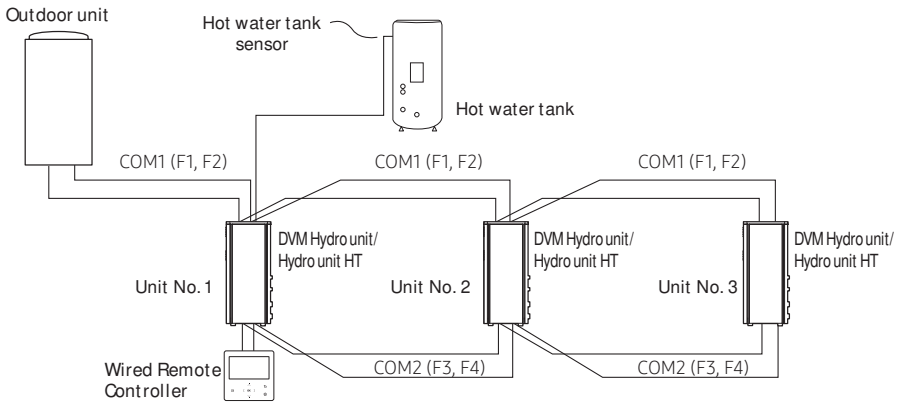

ex)

Unit No.	Water tank sensor cable wiring	05 Series install option SEG24 setting
1	Connected	0
2	Not connected	1
3	Not connected	1

Connecting 2 or more wired remote controller

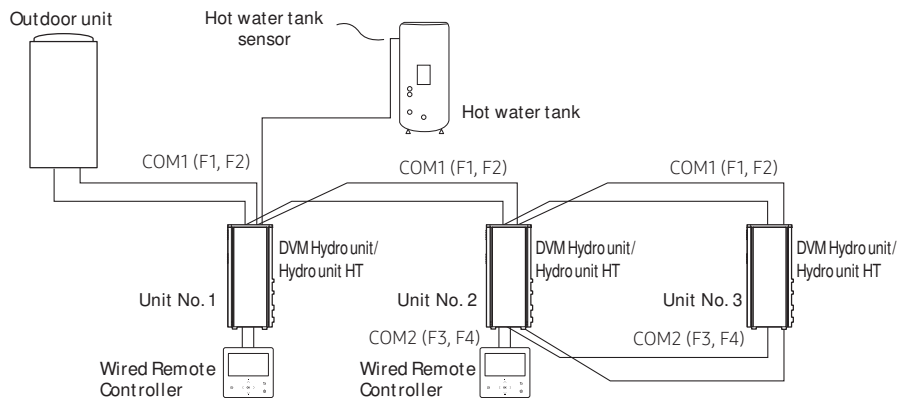

ex)

Unit No.	Water tank sensor cable wiring	05 Series install option SEG24 setting
1	Connected	0
2	Connected	0
3	Not connected	1



⚠ CAUTION

- If the DVM Hydro unit/Hydro unit HT needs to share the temperature value of the hot water tank, it must be connected to the same remote controller that is connected to other DVM Hydro unit/Hydro unit HT that is connected directly to the hot water tank with a temperature sensor. Also, when there are more than 2 wired remote controllers, they should be connected to same communication line.
- When multiple units (DVM Hydro unit/Hydro unit HT) are connected to one wired remote controller, type of the units must be same.
 - Different types of units (DVM Hydro unit/Hydro unit HT) should not be connected to the same wire remote controller

Wired Remote Controller Installation

Initializing Your Wired Remote Controller Communication

Wired remote controller must be initialized if installation status changes.

- Changing number of indoor unit or their address
- 1 Press the  and  buttons at the same time for more than 5 seconds.
 - Your Wired Remote Controller will be initialized, and the device will search for the indoor units connected to your Wired Remote Controller again.

Errors displayed on the Wired Remote Controller







Error codes for the Wired Remote Controller and the product connected to your Wired Remote Controller will be displayed in the LCD display.

Wired Remote Controller error codes

Display	Contents
E601	Communication error between remote controller and the Hydro unit/Hydro unit HT
E602	Communication error between master and slave remote controller
E604	Tracking error between remote controller and the Hydro unit/Hydro unit HT
E618	Error due to exceeding maximum numbers of Hydro unit installation (16 units)
E633	Error caused by installing mixed models
E653	Remote controller's temperature sensor is disconnected or has problem
E654	Data error on remote controller (Memory read/write error)

Installation/ Service mode

Additional functions of the Wired Remote Controller [See the image

- 1 If you want to use the various additional functions for your Wired Remote Controller, press the  and  buttons at the same time for more than 3 seconds.
 - The password entry screen appears.
- 2 Enter the password, "0202," and then press the **OK** button.
 - The settings screen for installation/service mode appears.
- 3 See the list of additional functions for the Wired Remote Controller on the next page, and then select the desired menu.
 - Once you have entered the setting screen, the current setting appears.
 - Refer to the chart for data setting.
 - Using the   buttons, change the settings and press the  button to move to the next setting.
 - Press the **OK** button to save the new setting.
 - Press the  button to move to the Home screen.

NOTE

- While setting the data, you can press the  button to move to the Home screen after checking the saving status at a pop-up screen.

Installation/ Service mode

Installation/ Service mode

 NOTE

- Unavailable functions are marked inactive and they cannot be set.
- If communication initialization is needed after the setting, the system will reset automatically and communication will be initialized.

Step 1	Step 2	Step 3	Description	Default	
Service Timer	Service Call Number		16-digit phone number Input : Blank, -, 0-9	-	
	Last Inspection		Year, Month, Day	-	
	Installation Date		Year, Month, Day	-	
Quiet Mode Automatic Time			Enable/ Disable	Disable	
			Entry time to Exit time	PM 10:00 ~ AM 06:00	
Indoor Zone Option	Cool/ Heat Selection		Cool & Heat/ Heat only	Cool & Heat	
	Master/Slave Wired Remote		Master/Slave	Master	
	Zone Selection		Zone 1/ Zone 2	Zone 1	
	Standard Temperature		Water Outlet/ Indoor	Water Outlet	
	Temperature Unit		Celsius(°C): 1°C/0.5°C/0.1°C	0.5°C	
	Temperature Sensor Selection		Wired Remote Controller/ External Temperature Sensor	Wired Remote Controller	
	Room Temperature Calibration	Reference Temperature		-9 to 40°C	-
		Calibration Value		-9 to 40°C	0°C
Indoor Zone Option	Indoor Zone Status Information	Central :	ON/OFF	-	
		Normal Power :	ON/OFF	-	
		Mode :	Heat/Cool/Auto	-	
		DHW Power :	ON/OFF	-	
		DHW Mode :	Economic/ Standard/ Power/ Forced	-	
		Water Pump :	ON/OFF	-	
		BUH :	ON/OFF	-	
		BSH :	ON/OFF	-	
		Flow sensor :	lpm	-	
		Inverter Pump :	0% ~ 100%	-	
		EEV Step :	0~2000Step	-	
		Thermostat 1 :	ON/OFF	-	
		Thermostat 2 :	ON/OFF	-	
DHW Thermostat :	ON/OFF	-			

Step 1	Step 2	Step 3	Description	Default	
Connection Information	Number of Connection		0 to 16	-	
	View Master Indoor Unit		Address	-	
	Master Indoor Zone Information	Serial No. :		-	-
		Indoor Unit Eva In Temp.(Teva_in) :		Temperature	-
		Indoor Unit Eva Out Temp.(Teva_out) :		Temperature	-
		Indoor Unit PHE IN(Tw1) :		Temperature	-
		Indoor Unit PHE OUT(Tw2) :		Temperature	-
		DHW Tank Temp. (Tt) :		Temperature	-
	DHW Mode :		Economic/ Standard/ Power/ Forced	-	
Device Information	Micom Code :		Micom code	-	
	Program Version :		Modified date	-	
	Touch Code :		Touch IC code	-	
	Program Version :		Modified date	-	
	Graphic Image :		Graphic image code	-	
	Program Version :		Modified date	-	
Reset All Service Modes	Erase All Service mode data		-	-	
	Initialize a remote controller		-	-	
Power Master Reset 1)*			-	-	
ODU K3 Reset			-	-	
Field Setting Value	10**		-	-	
	20**		-	-	
	30**		-	-	
	40**		-	-	
	50**		-	-	
	Simple Setting		-	-	
	FSV Upload/ Download		-	-	

Installation/ Service mode

Step 1	Step 2	Step 3	Description	Default
Self-Test Mode	Self-Test Mode Display	Water Inlet Temp. :	Temperature	-
		Water Outlet Temp. :	Temperature	-
		Backup Heater Outlet Temp. :	Temperature	-
		Mixing Valve Outlet Temp. :	Temperature	-
		Tank Temp. :	Temperature	-
		Indoor Ambient Temp. :	Temperature	-
		Indoor Ambient Temp.(Zone 2) :	Temperature	-
		Water Outlet Temp.(Zone 1) :	Temperature	-
		Water Outlet Temp.(Zone 2) :	Temperature	-
		Thermostat #1(Zone1) :	Heat/ Cool	-
		Thermostat #2(Zone 2) :	Heat/ Cool	-
		Solar Panel	ON/OFF	-
		Water Pump		ON/OFF
	Booster Heater		ON/OFF	OFF
	DHW Valve(3Way Valve)		ON/OFF	OFF
	Zone 1 Valve		ON/OFF	OFF
	Backup Heater 1 + Water Pump		ON/OFF	OFF
	Backup Heater 2 + Water Pump		ON/OFF	OFF
	Backup Boiler		ON/OFF	OFF
	Zone 2 Valve		ON/OFF	OFF
Mixing Valve		ON/OFF	OFF	

Installation/Service mode

Step 1	Step 2	Step 3	Description	Default
Indoor Unit Option	Address	Main address	00 to 4F	-
		RMC address	00 to FE	-
	Product Option 2)*		Refer to the installation manual of the connected indoor unit.	-
	Installation Option 1 2)*			-
	Installation Option 2 2)*			-
	MCU Port	MCU address	00 to 15	-
MCU Port		A to F	-	

1)* Power Master Reset is a setting needed to supply optimized power to wired remote controller when multiple indoor units are connected to wired remote controller in a group.

2)* The total option codes are 24 digits. You can set six digits at a time and it is distinguished by page number. Press the OK button to move to the next page. [See the image 

Installation/ Service mode

 NOTE

- Address is displayed in hexadecimal. Please refer to the following table.

Hexadecimal	Decimal
00	0
01	1
02	2
03	3
04	4
05	5
06	6
07	7
08	8
09	9
0A	10
0B	11
0C	12
0D	13
0E	14
0F	15

Hexadecimal	Decimal
10	16
11	17
12	18
13	19
14	20
15	21
16	22
17	23
18	24
19	25
1A	26
1B	27
1C	28
1D	29
1E	30
1F	31

Hexadecimal	Decimal
20	32
21	33
22	34
23	35
24	36
25	37
26	38
27	39
28	40
29	41
2A	42
2B	43
2C	44
2D	45
2E	46
2F	47

Hexadecimal	Decimal
30	48
31	49
32	50
33	51
34	52
35	53
36	54
37	55
38	56
39	57
3A	58
3B	59
3C	60
3D	61
3E	62
3F	63

Hexadecimal	Decimal
40	64
41	65
42	66
43	67
44	68
45	69
46	70
47	71
48	72
49	73
4A	74
4B	75
4C	76
4D	77
4E	78
4F	79

The example of Wired Remote Controller option setting method

- 1 Press the \wedge and \vee buttons at the same time for more than 3 seconds.
- 2 Enter the password, "0202," and then press the **OK** button.
- 3 Press the \wedge and \vee buttons to select "Indoor Unit option," and then press the **OK** button.
- 4 Press the \wedge and \vee buttons to select "Cool/ Heat selection," and then press the **OK** button.
 - The menu with the >shape can be selected using the \rangle button.
- 5 Press the \wedge and \vee buttons to select "Heat only," and then press the **OK** button to finish the setting.
- 6 Press the \curvearrowright button to move to the Home screen.

How to download to microSD Card

- 1 Download the wired remote controller image, change the file name to "IMAGE.BIN," and then download to microSD Card.
- 2 Download the wired remote controller program, change the file name to "MICOM.BIN," and then download to microSD Card.
- 3 Insert the microSD Card with the Wired Remote Controller active, and then reset the system.
For system reset, press the \langle and ⚙ buttons at the same time for more than 5 seconds.
- 4 The download to microSD Card is performed as follows:
 - Download proceeds in the order of IMAGE and MICOM.
 - When the update fails, the Wired Remote Controller is reset automatically and the update proceeds again.
- 5 When the download is finished, tracking starts automatically.
When tracking is completed, remove the microSD Card.

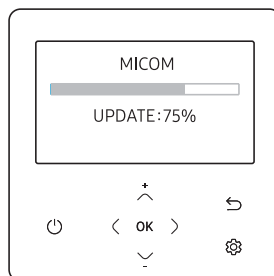
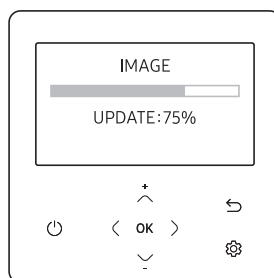



CAUTION

- Be sure to use the microSD Card after formatting in FAT16 or FAT32.
- The microSD Card supports the SD or SDHC with the capacity of 1 GB to 32 GB.
- The update is performed only when the file version in the microSD Card differs from the one of the Wired Remote Controller.
- When the screen is frozen for more than 3 minutes after completing the microSD card update by 100%, product inspection is required.
- Delete the files except for the ones for download.
(Only IMAGE.BIN and MICOM.BIN are required.)

Installation/ Service mode

When the microSD Card is removed during download

- 1 When you remove the microSD Card during download, the "INSERT MICROSD CARD AND SYSTEM RESET" screen appears and the download is stopped.
- 2 When you insert the microSD Card and press the  and  buttons for system reset, download starts again after finishing the reset.

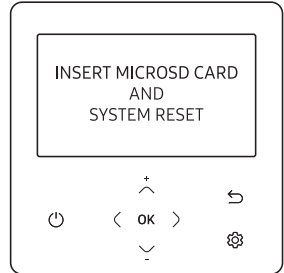

NOTE

- When you reset the Wired Remote Controller while the microSD Card is removed, the above message appears on the screen in standby mode.
- When you reset the Wired Remote Controller while the microSD Card is removed and then inserted, the following actions are performed.
 - If the reinserted microSD Card contains all the files for update, update proceeds regardless of the version of the file.
 - If the reinserted microSD Card contains any missing files for update, the above message appears in standby mode.



Self-test mode of wired remote controller

Use of self-test mode [See the image

- 1 If you want to use the various additional functions for your Wired Remote Controller, press the  and  buttons at the same time for more than 3 seconds.
 - The password entry screen appears.
- 2 Enter the password, "0202," and then press the **OK** button.
 - The settings screen for installation/service mode appears.
- 3 Select Self-Test Mode in Service Mode.
- 4 Self-Test Mode consists of Self-Test Mode Display that shows operation value status and menus that can turn each component on or off.

SAMSUNG

