

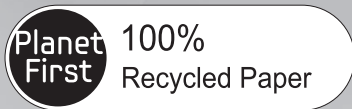

# DVM Hydro unit / Hydro unit HT installation manual



This manual is made with 100% recycled paper.



imagine the possibilities



Thank you for purchasing this Samsung product.



# Safety information

---

This installation manual explains how to install a wired remote controller connected to a Hydro unit/Hydro unit HT. Please read this manual thoroughly before installing the remote controller.  
(Please refer to the corresponding installation manual for product and other optional installation.)

 <b>WARNING</b>	Hazards or unsafe practices that may result in <b>severe personal injury or death</b> .
 <b>CAUTION</b>	Hazards or unsafe practices that may result in <b>minor personal injury or property damage</b> .

---

## WARNING

**Contact a service center for installation.**

- ▶ Failure to do so may result in product malfunction, water leak, electric shock and fire.

**Install the product with rated power supply.**

- ▶ Failure to do so may result in fire or damage to a wired remote controller.

**Do not modify or repair the wired remote controller yourself.**

- ▶ Failure to do so may result in product malfunction, electric shock, and fire. When you need to repair the product, you should contact a service center.

**All the electric work should be performed in accordance with local regulation and installation manual by a certified technician.**

- ▶ Failure to do so may result in product malfunction, electric shock and fire due to defect.

**Install the product on a hard and even surface that can support its weight.**

- ▶ If the surface cannot support its weight, the wired remote controller may fall down and it may cause product damage.

**Do not move or reinstall the connected wired remote controller yourself.**

- ▶ Failure to do so may result in electric shock and fire.

**Check whether the installation work is correctly performed in accordance with installation manual.**

- ▶ When the wired remote controller is incorrectly installed, electric shock and fire may occur.

**When disposing of the wired remote controller, please contact a service center.**

## CAUTION

---

**Do not install the product where inflammable content may leak.**

- ▶ Failure to do so may result in fire and explosion.

**Ensure no water gets into the wired remote controller.**

- ▶ Failure to do so may result in electric shock and fire.

**Install the product away from direct exposure to sunlight, in room temperature range of 0°C(32°F)~39°C(102°F).**

- ▶ Failure to do so may result in electric shock or abnormal operation.

**Do not handle the product with sharp objects.**

- ▶ Failure to do so may result in electric shock or part damage.

**Do not install the product in specific areas exposed to oil or vapor.**

- ▶ Failure to do so may result in part damage or abnormal operation.

**Do not put undue stress on the power cable.**

- ▶ Failure to do so may result in broken cable and fire.

**Do not install the product in areas where acid or alkali liquid or special spray are used.**

- ▶ Failure to do so may result in electric shock or abnormal operation.

**Do not connect power cable to a communication terminal.**







- ▶ Failure to do so may result in fire.

**Be cautious not to interfere with any other electrical devices if the product is installed in a place such as hospital.**

- ▶ Failure to do so may result in abnormal operation.

# Wired remote controller installation

## Accessories

Name	Wired remote controller	Cable tie	Cable clamp	M4X16 Screw	User Manual	Installation Manual	U-Terminal
Quantity	1	2	3	5	1	1	6
Shape							



- The wired remote controller should be installed by a certified technician.
- Check and confirm the power is off before installing your wired remote controller.
- Install the wired remote controller cables in accordance with the electrical wiring regulation, and allow it to pass through the inner area of the wall so that other people can't reach it.

## External Dimensions

Unit : mm(inch)

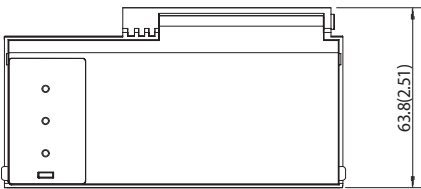
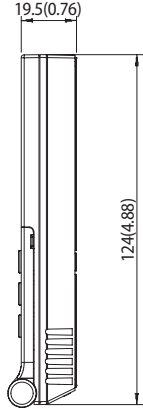
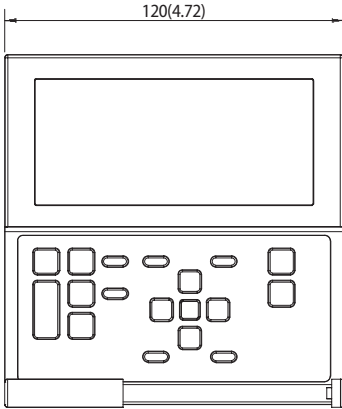

1. Push the two hooks at the bottom of your Wired Remote Controller at the same time, and then pull up the front cover to separate it from the rear cover.

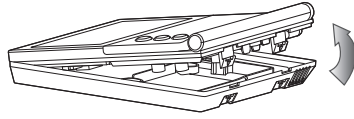
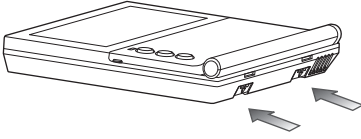

- \* Push the two hooks at the same time.



- Insert a flat head screwdriver into the square groove in the upper area of the hook to disassemble it easily.

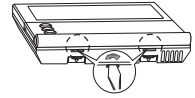

2. Arrange the communication cable so that they fit in the housing along the edges of the rear cover.

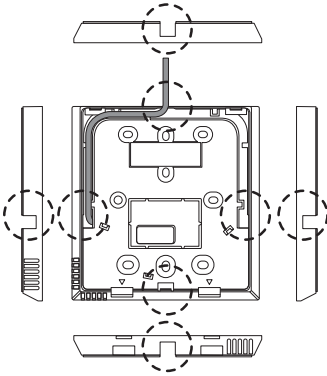

<When the cable is not concealed>

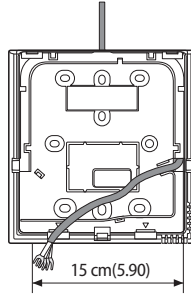

If you need more space for the wiring work, you can take it off.

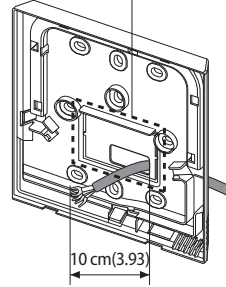

<When the cable is concealed>

# Wired remote controller installation

3. Using more than two screws, firmly affix the rear cover of the remote controller to the wall, and then connect communication cables(F3, F4), making sure these cables have reasonable length, to the terminal at the back of the cover.

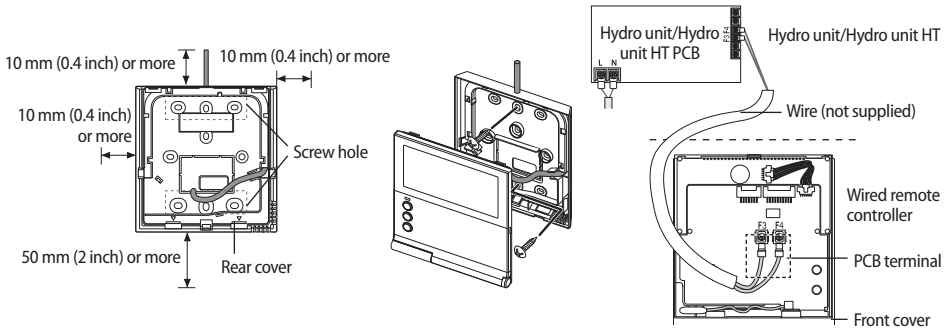

- \* Before fixing the rear cover, allow at least 10 mm(0.4 inch) space of upper side, left side, right side, and 50 mm(2 inch) space of bottom side.
- \* You must fit the screws into the screw holes.
- \* Do not tighten the screws on the PCB terminal with excessive force.

4. Reassemble your wired remote controller.



- Align the controller with the upper groove first, and insert it by turning it downward as shown in the figure. After assembly, check and confirm that no wires are stuck in the gap between the rear and front cover.





- When installing a wired remote controller by using a cable longer than 10 m, you must install the communication cable and the power cable separately. (Electrical interference can cause your wired remote controller to malfunction.)
- When installing your wired remote controller on the wall, consider the size of the wire hole, and select a wire with a proper thickness.
- Wire that is connectable to wired remote controller PCB.
  - If you install the wired remote controller by reclaiming, install it according to U-terminal cable specification.
  - If you install the wired remote controller by using four pieces of PVC wire, remove the 30 cm(12 inch) of the sheath of the cable and install it only with the four pieces of wires. (Recommended specification: AWG21)
  - The followings are the specs of the compressed ring terminal connectable to your wired remote controller PCB

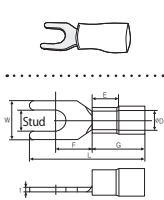

Range of Permitted Wires		Rated Size mm <sup>2</sup>	Stud Size mm	Basic Size (mm)							
AWG	mm <sup>2</sup>			t	øD	G	E	F	W	L	
22 ~ 16	0.25 ~ 1.65	1.5	3	0.7	3.8	10.0	4.5	6.5	6.0	21.2	

\* Maximum distance for connection between communication cable and power cable: 100 m

- Screws on the PCB terminal must be tightened with less than 6N·m tightening torque. If the tightening torque is greater, it may damage the screw thread.

# Wired remote controller installation

## Tracking Hydro unit/Hydro unit HT from a wired remote controller

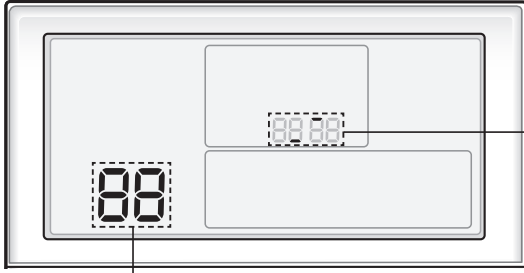

Display tracking is being performed.

The number of Hydro unit/Hydro unit HT currently detected

1. Tracking of your wired remote controller will automatically start when you turn on the power after installation.
2. If you want to perform tracking again after installation, press the **Esc** and **Delete** buttons at the same time for more than 5 seconds.
  - ▶ The system will reset, and tracking will start again.
3. During the tracking, the total number of currently searched Hydro unit/Hydro unit HT will be displayed.



• If you want to do system reset for your wired remote controller, press the **Esc** and **Delete** buttons at the same time for more than 5 seconds.

## Individual control with your wired remote controller

- ▶ Individual control means that you are using one remote controller to control one indoor unit or one Hydro unit/Hydro unit HT.

When connecting the Hydro unit/Hydro unit HT only

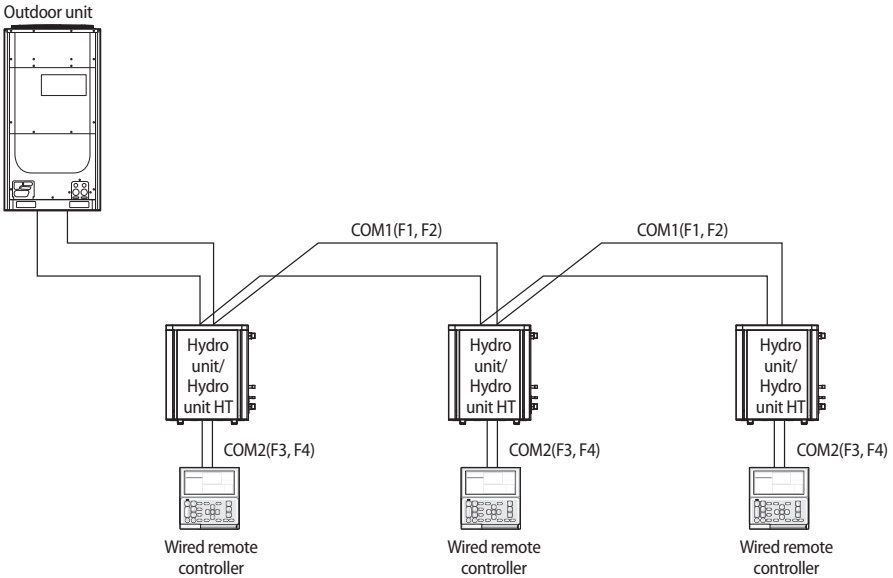

- Regardless of the Hydro unit/Hydro unit HT group address (RMC address) setting, only the Hydro unit/Hydro unit HT connected to COM2 is individually controlled.

# Wired remote controller installation

## Group control with your wired remote controller

- ▶ Group control means that you are using one wired remote controller to control two or more Hydro unit/Hydro unit HTs at the same time.

When connecting the Hydro unit/Hydro unit HT only

- 1) Using one wired remote controller to control three Hydro unit/Hydro unit HTs

Outdoor unit

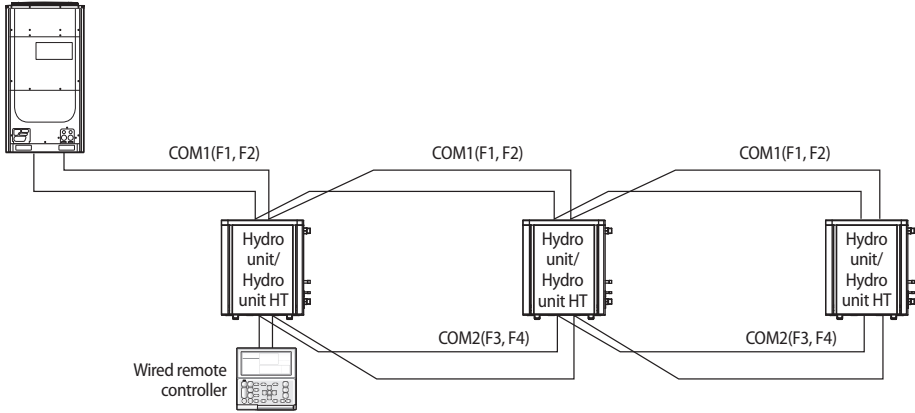

- 2) Using one wired remote controller to control Hydro unit/Hydro unit HTs connected to different outdoor unit

Outdoor unit

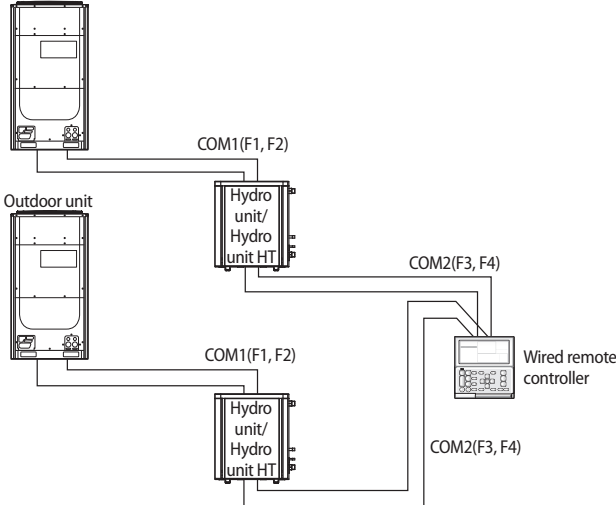

- Regardless of the Hydro unit/Hydro unit HT group address (RMC address), only the Hydro unit/Hydro unit HTs connected to COM2 are controlled in group.
- Regardless of your outdoor units, you can control a maximum of 16 Hydro unit/Hydro unit HTs as a group.

## Controlling 2-remote controller

- ▶ 2-Remote controller is controlling one Hydro unit/Hydro unit HT with two remote controllers.
- ▶ When setting the wired remote controller as 'Indoor temperature standard/wired remote controller sensor use', please install the master remote controller at indoor places.

Outdoor unit

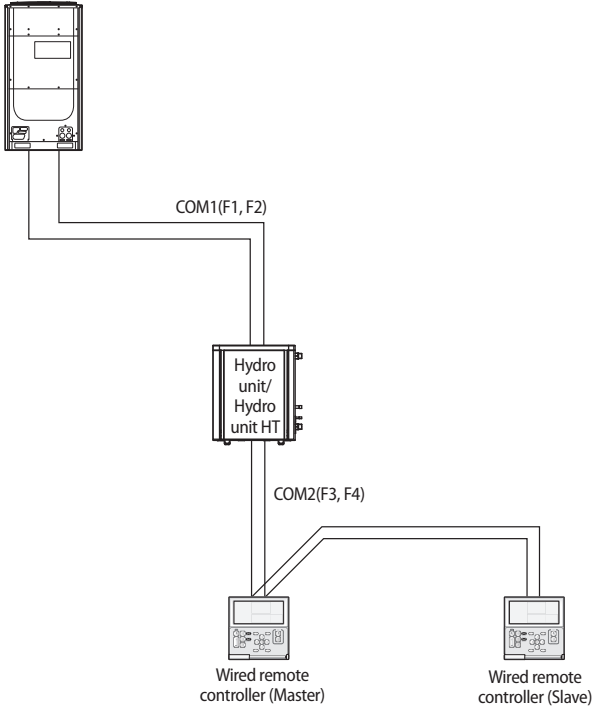

• For the slave wired remote controller settings, please refer to the sections about the wired remote controller installation/service mode. (Refer to page 15) 0: Master, 1: Slave

# Wired remote controller installation

## Initializing your wired remote controller communication

1. Press the **Esc** and **Delete** buttons at the same time for more than 5 seconds.
  - ▶ The communication of your wired remote controller will be initialized, and the device will search for the Hydro unit/Hydro unit HT connected to your wired remote controller again.

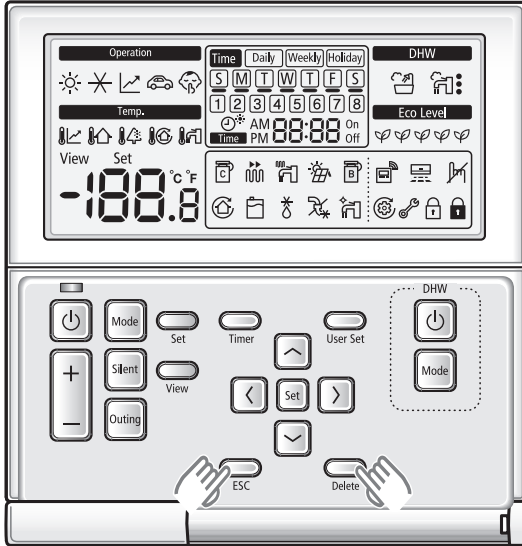

## Error display on the wired remote controller

- \* The address of Hydro unit is displayed "200000"
- ▶ Error codes for the wired remote controller and the product connected to your wired remote controller will be displayed in the LCD display.

**Error indications are displayed as seen below.**

- 1) Hydro unit/Hydro unit HT error
  - ▶ The address of Error, "Ai" and the error code will be displayed alternately on the remote controller display.

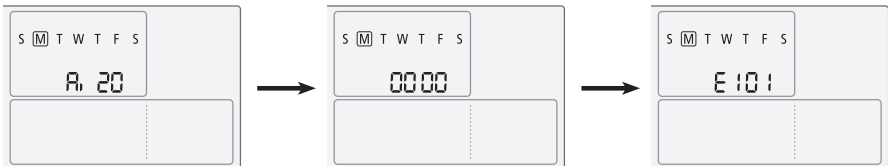

## 2) Outdoor unit error

- ▶ The address of Error, "Ao" and error code will be displayed alternately on the remote controller display.

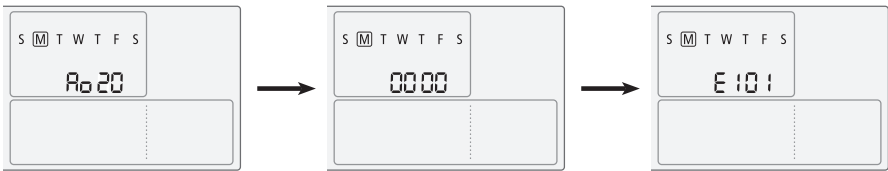

## 3) Wired remote controller error

- ▶ The error code will blink at 0.5 second interval on the remote controller display and the address of error will not be displayed.

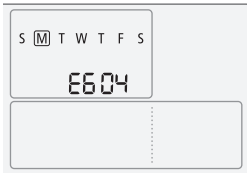

### Wired remote controller error code

#### Error codes

For errors on Hydro unit, please refer to the installation manual of the Hydro unit.

Display	Contents
E601	Communication error between remote controller and the Hydro unit/Hydro unit HT
E602	Communication error between master and slave remote controller
E604	Tracking error between remote controller and the Hydro unit/Hydro unit HT
E618	Error due to exceeding maximum numbers of Hydro unit installation (16 units)
E627	Error due to exceeding maximum numbers of wired remote controller installation (2 units)
E633	Error caused by installing mixed models
E653	Remote controller's temperature sensor is disconnected or has problem
E654	Data error on remote controller (Memory read/write error)

# Use of wired remote controller installation / service mode

## Use of installation/service mode

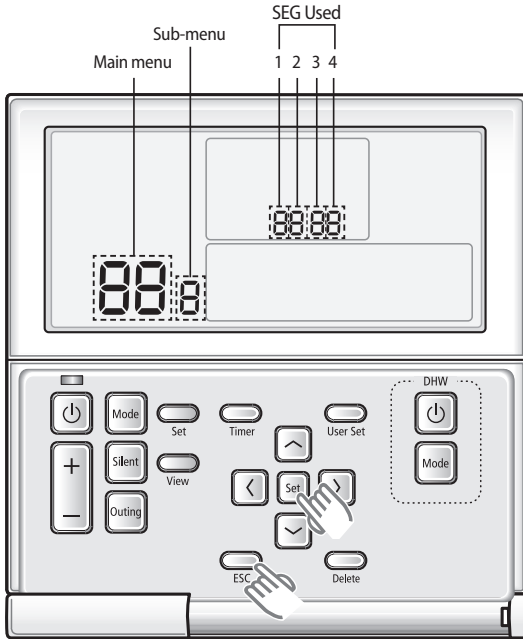

1. If you want to use the installation/service mode for your wired remote controller, press the **Set** and **ESC** buttons at the same time for more than 3 seconds.
  - ▶ You will enter the installation/service settings, and the 'main menu' will be displayed.
2. Refer to the list of installation / service setting mode for your wired remote controller on the next page, and select the desired menu.
  - ▶ Using the [**^**]/[**v**] buttons, select a main menu number and press the [**>**] button to enter the sub-menu setting screen.
  - ▶ Using the [**^**]/[**v**] buttons, select a sub-menu number and press the [**>**] button to enter data setting screen.
  - ▶ When you enter the setting stage, the current setting value will be displayed.
  - ▶ Refer to the chart for data settings.
  - ▶ Using the [**^**]/[**v**] buttons, change the setting value. Press the [**>**] button to move to the next setting value.
  - ▶ Press the **Set** button to save the setting value and exit to the sub-menu setting screen.
  - ▶ Press the **ESC** button to exit to normal mode.



NOTE

- When setting the data, you can move SEG range with [**<**]/[**>**] buttons.
- While configuring the setting, press the **ESC** button to exit to the sub-menu setting screen without saving your changes.
- When you don't enter any buttons for more than 3 minutes, you will be back to normal mode.

## Installation/Service mode



- 'NONE' will be displayed for the menu that setting modes don't support. In some cases, the setting may not be possible or it may not be applied though it is set on the unit.
- If communication initialization is needed after saving the setting, the system will reset automatically and communication will be initialized.

Main Menu	Sub Menu	Function	SEG number	Default	Range	Unit	
1	1	Wired remote controller's option function set / Check 1	Cooling support Y / N	1	0	0-Both cooling & heating	-
			Selecting the standard temperature of cooling and heating	2	0	0-Water Outlet temperature 1-Indoor temperature	-
			Selecting a standard sensor of indoor temperature	3	0	0-Temperature sensor of wired remote controller 1-External temperature sensor	-
			Selecting Master/Slave	4	0	0-Master, 1-Slave	-
	2	Wired remote controller's option function set / Check 2	Checking current sensor temperature value	123	0	-9~40 °C	-
			Setting compensation temperature value	123	0	-9.9~9.9 °C	0.1 °C
	4	Checking the number of connected devices	The number of connected device	1,2	0	0~16	1
	5	Setting desired temperature unit (Available only when the temperature display is °C)		1	1	0-1 °C, 1-0.5 °C, 2-0.1 °C	-
0	Reset to option setting default value of wired remote controller		1	0	0-Disuse, 1-Reset	-	
2	1	Checking Micom code of wired remote controller	1234, 4	-	Micom code	-	
	2	Checking version information of wired remote controller	1234, 34	-	Revision date	-	
3	1	Setting Hydro unit/ Hydro unit HT option	Hydro unit/Hydro unit HT address Set/Check	1234	-		
	2		Basic Option Set/Check	1234, 12	-	Option code	
	3		Install Option Set/Check	1234, 12	-	Option code	
	4		Install(2) Option Set/Check	1234, 12	-	Option code	
4	1	View Master Set/ Check	Hydro unit/Hydro unit HT View Master Set/Check	1234, 34	-	Address	
	2	Master Hydro unit/ Hydro unit HT Set/ Check	Check the Master Hydro unit/Hydro unit HT address	1234, 34	-	Address	
	3		Master Hydro unit/Hydro unit HT Set	1	-	0-Disuse, 1-Use, 2-Reset	
0	Reset	Wired remote controller factory Reset	1	0	0-Disuse, 1-Reset	-	
		Power Master Reset	1	0	0-Disuse, 1-Reset	-	
		Addressing Reset(Outdoor unit Reset)	1	0	0-Disuse, 1-Reset	-	

# Use of wired remote controller

## Use of user setting mode

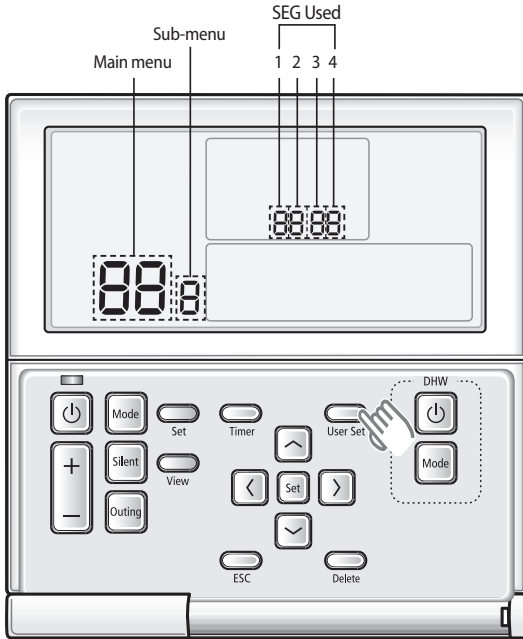

1. If you want to use the various user setting modes for your wired remote controller, press the **User Set** button.
2. Refer to the list of user setting mode for your wired remote controller on the next page, and select the desired menu.
  - ▶ Using the [ $\wedge$ ]/[ $\vee$ ] buttons, select a main menu number and press the [ $\>$ ] button to enter the sub-menu setting screen.
  - ▶ Using the [ $\wedge$ ]/[ $\vee$ ] buttons, select a sub-menu number and press the [ $\>$ ] button to enter data setting screen.
  - ▶ When you enter the setting stage, the current setting value will be displayed.
  - ▶ Refer to the chart for data settings.
  - ▶ Using the [ $\wedge$ ]/[ $\vee$ ] buttons, change the setting value. Press the [ $\>$ ] button to move to the next setting value.
  - ▶ Press the **Set** button to save the setting value and exit to the sub-menu setting screen.
  - ▶ Press the **ESC** button to exit to normal mode.



NOTE

- When setting the data, you can move SEG range with the [ $\<$ ]/[ $\>$ ] buttons.
- While configuring the setting, press the **ESC** button to exit to the sub-menu setting screen without saving your changes.
- When you don't enter any buttons for more than 3 minutes, you will be back to normal mode.

## User setting mode



- 'NONE' will be displayed for the menu that setting modes don't support. In some cases, the setting may not be possible or it may not be applied though it is set on the unit.
- If communication initialization is needed after saving the setting, the system will reset automatically and communication will be initialized.
- When you don't use summer time, you don't need to set year/month.

Main menu	Sub-menu	Function	SEG number	Default	Range	Unit	
1	1	All lock	1	0	0-Unclock, 1-Lock	-	
	2	Partial key lock	Operation On/Off key lock	1	0	0-Unclock, 1-Lock	-
			Operation selection key lock	2	0	0-Unclock, 1-Lock	-
			Temperature setting key lock	3	0	0-Unclock, 1-Lock	-
			Timer setting key lock	4	0	0-Unclock, 1-Lock	-
2	1	Current time setting(year)	12/34	2013	2000~2099	Year	
	2	Current time setting(month/date)	12/34	01/01	1~12/1~31	Month, Date	
	3	Current time setting (day/hour/minute)	Day, AM / PM, 24, 12/34	Fri., PM, 12/00	Sun~Sat/ AM~PM/ 0~12/0~60	Day, hour, minute	
3	1	Summer time use and setting methods	Use of summer time (Y/N)	1	0	0- Disuse, 1- Use	-
			Summer time application method	2	0	0- Weekly, 1- Daily	-
	2	Summer time use (weekly) Start (? month, ? th Sunday)	12,4	03,F	Jan~Dec month 1~4, F(last week) th week	-	
	3	Summer time use (weekly) End (? month, ? th Sunday)	12,4	10,F	Jan~Dec month 1~4, F(last week) th week	-	
	4	Summer time use (daily) Start (? month, ? date)	12,34	0322	Jan~Dec/1~31st day	Month, date	
5	Summer time use (daily) End (? month, ? date)	12,34	0922	Jan~Dec/1~31st day	Month, date		
4		Backlight time Setting/Checking	12	5	0~30 sec.	1 sec.	
		Use of LED(Green) (Y/N)	3	1	0- Disuse , 1- Use	-	
		Use of LED (Red) (Y/N)	4	1	0-Disuse, 1- Use	-	
0		Reset to user mode defaults (except the current time)	1	0	0-Disuse, 1- Reset	-	

# Field specification setting mode of wired remote controller

## Use of field specification setting mode

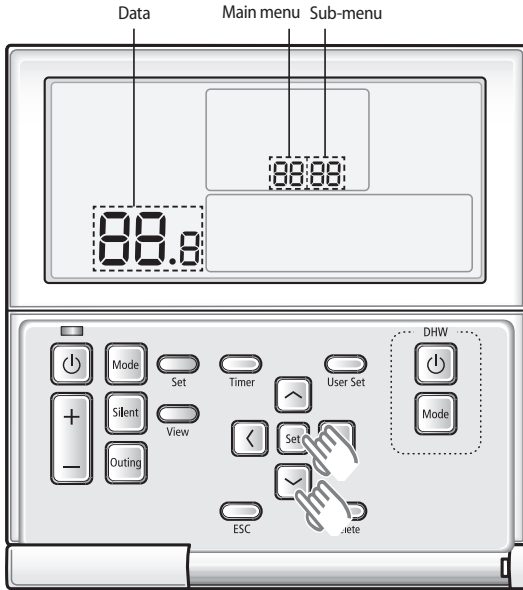

1. If you want to use the field specification setting mode for your wired remote controller, press the Set and [V] buttons at the same time for more than 3 seconds.
2. Refer to the list of field specification for your wired remote controller on the next page, and select the desired menu.
  - ▶ Using the [^]/[v] buttons, select a main menu number and press the [>] button to enter the sub-menu setting screen.
  - ▶ Using the [^]/[v] buttons, select a sub-menu number and press the [>] button to enter data setting screen.
  - ▶ When you enter the setting stage, the current setting value will be displayed.
  - ▶ Refer to the chart for data settings.
  - ▶ Using the [^]/[v] buttons, change the setting value and press the Set button to save the setting value. Setting value will be displayed when it is saved.
  - ▶ Press the [<] button to move previous setting value.
  - ▶ While configuring the sub menu setting, press the ESC button to exit to normal menu.



NOTE

- While configuring the setting, press the ESC button to exit to the sub-menu setting screen without saving your changes.
- When you don't enter any buttons for more than 3 minutes, you will be back to normal mode.

## Field specification setting mode

### 1. Hydro unit

Classification	Function	Detail	Code	Basic	Min.	Max.	Step	Unit
Remote controller	Temperature of general cooling leaving water	Max.	1011	25	18	25	1	°C
		Min.	1012	16	5	18	1	°C
	General indoor cooling temperature	Max.	1021	30	28	30	1	°C
		Min.	1022	18	18	28	1	°C
	Temperature of general heating leaving water	Max.	1031	50	37	50	1	°C
		Min.	1032	25	15	37	1	°C
	General indoor heating temperature	Max.	1041	30	18	30	1	°C
		Min.	1042	16	16	18	1	°C
	Temperature of hot water tank	Max.	1051	50	40	75	1	°C
		Min.	1052	35	30	40	1	°C
Water Law	Auto heating ambient temperature	Max.	2011	-10	-20	5	1	°C
		Min.	2012	15	10	20	1	°C
	Temperature of auto heating leaving water (WL1-Floor)	Max.	2021	45	35	50	1	°C
		Min.	2022	30	17	37	1	°C
	Temperature of auto heating leaving water (WL2-FCU)	Max.	2031	50	35	50	1	°C
		Min.	2032	35	17	37	1	°C
	Auto heating of wired remote controller	WL type	2041	1(WL1)	1	2	-	-
	Use of thermostat	#1(Floor)	2091	0(No)	0	1(Yes)	-	-
		#2(FCU)	2092	0(No)	0	1(Yes)	-	-
	DHW	Activating hot water function	DHW application	3011	0(No)	0	1(Yes)	-
Heat pump		Max.	3021	50	45	50	1	°C
		Stop	3022	2	2	10	1	°C
		Start	3023	5	5	20	1	°C
		Min. hour	3024	5	1	20	1	min.
		Max. hour	3025	30	5	95	5	min.
		Operation interval	3026	3	0.5	10	0.5	hour
Booster heater		Operation	3031	1 (Yes)	0 (No)	1	-	-
		Delayed time	3032	20	20	95	5	min.
		Overshoot	3033	0	0	4	1	°C
		Compensation temperature	3034	10	0	20	1	°C
Disinfection		Operation	3041	1 (Yes)	0 (No)	1	-	-
		Operation interval	3042	Fri(5)	Sun(0)	AllDay(7)	-	day
		Start time	3043	23	0	23	1	hour
		Target temp.	3044	70	40	70	5	°C
		Holding time	3045	10	5	60	5	min.
Solar heat panel		H/P interlocking	3061	0 (No)	0	1 (Yes)	-	-

# Field specification setting mode of wired remote controller

Classification	Function	Detail	Code	Basic	Min.	Max.	Step	Unit
Heating	Heat pump	Heating/hot water priority	4011	0 (Hot water)	0	1 (Heating)	-	-
		Heating priority	4012	0	-15	20	1	°C
		Heating Off	4013	35	14	35	1	°C
		Overshoot	4014	2	1	4	1	°C
Others	Outing mode	Temperature of cooling water outlet	5011	25	5	25	1	°C
		Room Temperature of cooling Mode	5012	30	18	30	1	°C
		Temperature of heating leaving water	5013	15	15	50	1	°C
		Indoor heating temperature	5014	16	16	30	1	°C
		Temperature of auto heating WL1 water	5017	15	15	50	1	°C
		Temperature of auto heating WL2 water	5018	15	15	50	1	°C
		Temperature of hot water Tank	5019	30	30	75	1	°C
	Economic DHW mode	Temperature of hot water Tank	5021	5	0	40	1	°C
	Benefit kWh (Power Peak control)	Operation	5041	0 (No)	0	1 (Yes)	-	-
		Heat source for operation limit	5042	0 (All)	0	2	1	-
		Contact Logic	5043	1 (High)	0 (Low)	1	-	-
	Ratio of hot water supply compare to heating	A/7 (Ratio is determined based on the value of the A)7 means Heating capacity=Hot water capacity	5061	7	1	7	1	-



• The menu not supported by the product will not be displayed.

## 2. Hydro unit HT

Classification	Function	Detail	Code	Basic	Min.	Max.	Step	Unit
Remote controller	Temperature of general cooling leaving water	Max.	1011	-	-	-	1	°C
		Min.	1012	-	-	-	1	°C
	General indoor cooling temperature	Max.	1021	-	-	-	1	°C
		Min.	1022	-	-	-	1	°C
	Temperature of general heating leaving water	Max.	1031	80	40	80	1	°C
		Min.	1032	25	25	40	1	°C
	General indoor heating temperature	Max.	1041	30	18	30	1	°C
		Min.	1042	16	16	18	1	°C
Temperature of hot water tank	Max.	1051	70	45	75	1	°C	
	Min.	1052	45	35	45	1	°C	
Water Law	Auto heating ambient temperature	Max.	2011	-10	-20	5	1	°C
		Min.	2012	15	10	20	1	°C
	Temperature of auto heating leaving water (WL1-Floor)	Max.	2021	45	35	80	1	°C
		Min.	2022	30	25	80	1	°C
	Temperature of auto heating leaving water (WL2-FCU)	Max.	2031	50	35	80	1	°C
		Min.	2032	35	25	80	1	°C
	Auto heating of wired remote controller	WL type	2041	1(WL1)	1	2	-	-
	Use of thermostat	#1(Floor)	2091	0(No)	0	1(Yes)	-	-
#2(FCU)		2092	0(No)	0	1(Yes)	-	-	
DHW	Activating hot water function	DHW application	3011	0(No)	0	1(Yes)	-	-
	Heat pump	Max.	3021	70	45	75	1	°C
		Stop	3022	2	2	10	1	°C
		Start	3023	5	5	20	1	°C
		Min. hour	3024	5	1	20	1	min.
		Max. hour	3025	30	5	95	5	min.
		Operation interval	3026	3	0.5	10	0.5	hour
	Booster heater	Operation	3031	1 (Yes)	0 (No)	1	-	-
		Delayed time	3032	20	20	95	5	min.
		Overshoot	3033	0	0	4	1	°C
		Compensation temperature	3034	10	0	20	1	°C
	Disinfection	Operation	3041	1 (Yes)	0 (No)	1	-	-
		Operation interval	3042	Fri(5)	Sun(0)	AllDay(7)	-	day
		Start time	3043	23	0	23	1	hour
		Target temp.	3044	70	60	75	5	°C
		Holding time	3045	10	5	60	5	min
Solar heat panel	H/P interlocking	3061	0(No)	0	1(Yes)	-	-	
Heating	Heat pump	Heating/hot water priority	4011	0 (Hot water)	0	1 (Heating)	-	-
		Heating priority	4012	0	-15	20	1	°C
		Heating Off	4013	35	14	35	1	°C
		Overshoot	4014	2	1	4	1	°C

# Field specification setting mode of wired remote controller

Classification	Function	Detail	Code	Basic	Min.	Max.	Step	Unit
Others	Outing mode	Temperature of cooling water outlet	5011	-	-	-	1	°C
		Room Temperature of cooling Mode	5012	-	-	-	1	°C
		Temperature of heating leaving water	5013	25	25	80	1	°C
		Indoor heating temperature	5014	16	16	30	1	°C
		Temperature of auto heating WL1 water	5017	25	25	80	1	°C
		Temperature of auto heating WL2 water	5018	25	25	80	1	°C
		Temperature of hot water Tank	5019	35	35	75	1	°C
	Economic DHW mode	Temperature of hot water Tank	5021	5	0	40	1	°C
	Benefit kWh (Power Peak control)	Operation	5041	0 (No)	0	1 (Yes)	-	-
		Heat source for operation limit	5042	0 (All)	0	2	1	-
		Contact Logic	5043	1 (High)	0 (Low)	1	-	-
	Ratio of hot water supply compare to heating	A/7 (Ratio is determined based on the value of the A)7 means Heating capacity=Hot water capacity	5061	7	1	7	1	-

## Functions that requires setting according to field specification

► Code: 10\*\*

- Upper and lower temperature limits for Heating (Water out, Room), Cooling (Water out, room), DHW (Tank) mode

► Code: 20\*\*

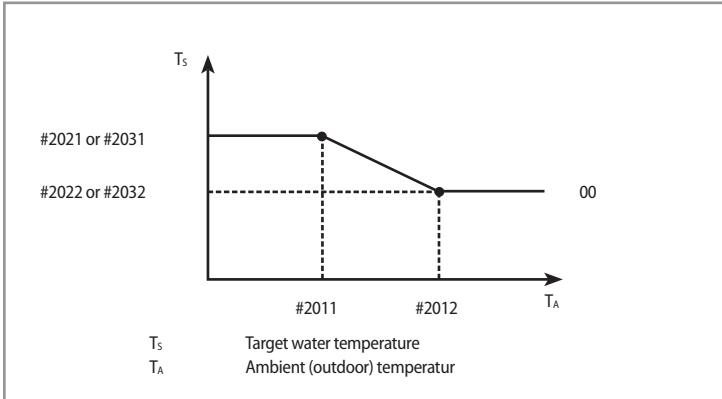

- 1) In case of outdoor temperature ( $T_a$ ) $^{\circ}\text{C} < (\text{Code } \#2011)^{\circ}\text{C}$ 
  - Code #2041: 1 (Floor) Setting  $T_s = \#2021$
  - Code #2041: Setting 2 (Fan Coil Unit)  $T_s = \#2031$
- 2) In case of ( $\text{Code } \#2011)^{\circ}\text{C} \leq \text{outdoor temperature}(T_a)^{\circ}\text{C} < (\text{Code } \#2012)^{\circ}\text{C}$ 
  - Code #2041: Setting 1(Floor)  $T_s = \#2021 + (\#2022 - \#2021) / (\#2012 - \#2011) * (T_a - \#2011)$
  - Code #2041: Setting 2(Fan Coil Unit)  $T_s = \#2031 + (\#2032 - \#2031) / (\#2012 - \#2011) * (T_a - \#2011)$
- 3) In case of ( $\text{Code } \#2012)^{\circ}\text{C} \leq \text{outdoor temperature}(T_a)^{\circ}\text{C}$ 
  - Code #2041: Setting 1(Floor)  $T_s = \#2022$
  - Code #2041: Setting 2(Fan Coil Unit)  $T_s = \#2032$

Code 209\*: Application of external thermostat in user's system (Floor or Fan coil unit)

► Code 30\*\*

- User's options for domestic hot water (DHW) tank heating

3011: Application of DHW tank

302\*: Heat pump variables for tank temp. control and combination with booster heater

- 3021: Maximum DHW tank temperature with heat pump (H/P) operation
- 3022: Temperature difference determining the heat pump OFF temperature (Set Temp (Code #3021) - Code #3022 = H/P off)
- 3023: Temperature difference determining the heat pump ON temperature (H/P off temp - Code #3023 = H/P on)
- 3024: Minimum Heating operating time
- 3025: Maximum DHW operating time
- 3026: Maximum duration of heating operation

303\*: Booster heater variables for combination with heat pump

- 3031: Application of Booster heater
- 3032: Booster heater startup delay timer
- 3033: Temperature difference determining the booster heater OFF temperature (Set temp + Code #3033 = booster heater off)

# Field specification setting mode of wired remote controller

304\*: Setting hot water tank disinfection period

- 3041: Application of disinfection function
- 3042: Scheduling (day)
- 3043: Starting time (hour)
- 3044: Target tank temp
- 3045: Duration time (After reaching the target temperature)
- 3061: Combination of external field solar panel for with heat pump for DHW heating

▶ Code 401\*

- Space/DHW heating priority and control variables

▶ Code 50\*\*

- User's options for extra functions

501\*: New target temperatures of each mode (Heating/Cooling/DHW) when "Outing" function is on

- 5021: Economic DHW mode (Subtract the value of code #5021 from the current target temperature of DHW tank, so that only heat pump is operating)

504\*: Peak power control

- 5041: Enable/Disable Peak power control
- 5042: Limited driving heat source (When value of #5042 is; 0 (default): Disable heater while external contact maintains at high, 1: Enable booster heater)
- 5043: Input voltage can be set to High/Low
- 5061: Water supply capacity ratio compared to heating: The load of hot water tank if designed heating (floor or Fan coil unit) load is 7

ex) When required heating load is 14000W, required hot water tank load  $10000W$ ,  $10000/14000 \times 7 = \text{Set } 5$

## Use of field specification checking mode

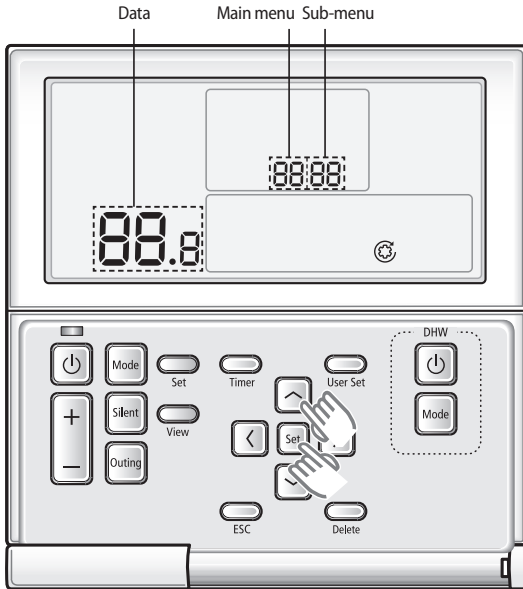

1. If you want to use the field specification checking mode for your wired remote controller, press the Set and [ $\wedge$ ] buttons at the same time for more than 3 seconds.
2. Refer to the list of field specification for your wired remote controller on the next page, and select the desired menu.
  - ▶ Using the [ $\wedge$ ]/[ $\vee$ ] buttons, select a main menu number and press the [ $>$ ] button to enter the sub-menu checking screen.
  - ▶ Using the [ $\wedge$ ]/[ $\vee$ ] buttons, select a sub-menu number and press the [ $>$ ] button to enter data checking screen.
  - ▶ When you enter the checking stage, the current setting value will be displayed.
  - ▶ Press the [ $<$ ] button to move previous setting value.
  - ▶ While configuring the sub menu setting, press the ESC button to exit to normal menu.



NOTE

- While configuring the checking, press the ESC button to exit to the sub-menu setting screen.
- When you don't enter any buttons for more than 3 minutes, you will be back to normal mode.

# Self-test mode of wired remote controller

## Use of self-test mode

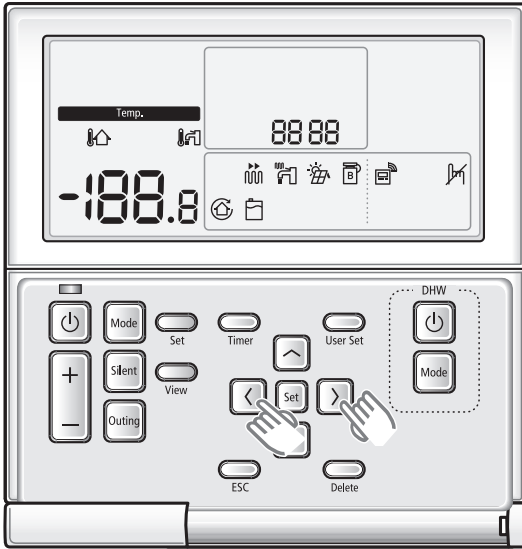

1. You can use the self-test mode when you set the 'self-test entering' as 'Yes' in the installation/service mode.
  - ▶ Select main menu 1 → sub-menu 2 in the installation / service mode.
2. When using the self-test mode of the wired remote controller, press the [ $\leftarrow$ ] and [ $\rightarrow$ ] buttons for more than 3 seconds.
3. You can operate the self-test mode as follows.
  - ▶ Load list: When pressing the corresponding button, you can set the load On or Off.

Enter button	Operating part	LCD display
	Water pump	
	Booster heater	
	DHW valve	
	2 way valve	2-1



- ▶ Thermostat 1, 2, and solar heat panel are displayed as below when you set them with an indoor unit.

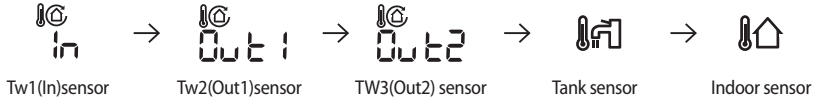

Thermostat 1 (Zone 1), Thermostat 2 (Zone 2), Solar heat panel (ON/OFF)

- ▶ Timer button: Whenever you press the button, the sensor value will be displayed in order.



- ▶ While the sensor value is being displayed but you don't press the 'Timer' button for 5 seconds, the previous status will be shown.
- ▶ For the sensor fault or absence of sensor installation, corresponding sensor temperature will be displayed as "Er".
- ▶ When you press the button that does not have a function,  will blink for 3 seconds.
- ▶ When pressing the **Delete** button one time, all the loads will be Off.
- ▶ When all the loads are OFF status, "Cancel" Key input will be ignored and  will blink for 3 seconds.
- ▶ When pressing the **ESC** button, you will exit to the general mode.