

Air conditioner

Installation manual

Wired remote controller MWR-SH11N

- Thank you for purchasing this Samsung Product.
- Before operating this unit, please read this installation manual carefully and retain it for future reference.



DB68-08073A-00

SAMSUNG

Contents

Preparation

Safety precautions	3
Before installation	5

Installation

Wired remote controller installation	6
--	---



Others

Wired remote controller installation/service mode	15
---	----

The lowest set temperature is limited to 20 degree in the UAE according to UAE.S 5010-5:2016.

Safety precautions

This installation manual explains how to install a wired remote controller connected to the indoor unit of your Samsung system air conditioner. Please read this manual thoroughly before installing the product.
(Please refer to appropriate installation for any optional product installation.)

 WARNING	Hazards or unsafe practices that may result in severe personal injury or death .
 CAUTION	Hazards or unsafe practices that may result in minor personal injury or property damage .

WARNING

Contact a service center for installation.

- ▶ Potential risk of malfunction, water leak, electric shock and fire.

Install the product with proper power supply.

- ▶ Potential risk of fire or product damage.

Consult the place of purchase or a contact center to disassemble or repair the product.

- ▶ Potential risk of malfunction, electric shock, or fire.

The electric work must be done by qualified person according to national wiring regulations and installation guide.

- ▶ If an unauthorized person performs the installation, any resulting defects can cause malfunctions, electrical shocks, or fire accidents.

Install the product on a hard and even place that can support its weight.

- ▶ If the place cannot support its weight, the product may fall down and it may cause product damage.

Do not move or reinstall the product on your discretion.

- ▶ Potential risk of electric shock or fire.

Check if the installation work is done correctly according to the installation manual.

- ▶ Incorrect installation may cause electric shock or fire.

When you want to dispose your wired remote controller, ask the service center.

Safety precautions

CAUTION

Do not install the product where there's combustible gas.

- ▶ Potential risk of fire and explosion.

Ensure no water gets into the wired remote controller.

- ▶ Potential risk of electric shock or fire.

Install the air conditioner away from direct exposure to sunlight, in room temperature range of 0°C(32°F) ~ 39°C(102°F).

- ▶ Potential risk of electric shock or malfunction.

Do not handle the product with sharp objects.

- ▶ Potential risk of electric shock or product damage.

Do not install the product in areas exposed to oil or vapor.

- ▶ Potential risk of product damage or malfunction.

Do not put undue stress on the power cable.

- ▶ Potential risk of broken cable and fire.

Do not install the product in areas with frequent use of acid or alkali spray.

- ▶ Potential risk of electric shock or product malfunction

Do not connect power cable to a communication terminal.

- ▶ Potential risk of fire.

Be cautious not to interfere any other electrical devices if the product is installed in a place such as hospital.



- ▶ Potential risk of product malfunction.

Please take the product gently after unpacking the package.

- ▶ Drop or throwing can lead to the potential risk of product damage.

Before installation

Optional accessories

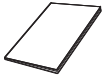
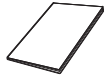
Wired remote controller (1)	M4x16 screw (4)	User manual (1)	Installation manual (1)
			



- The wired remote controller should be installed by an installation expert.
- Check and confirm the power is off before installing your wired remote controller.
- Install the wired remote controller cables in accordance with the electrical wiring rules, and allow it to pass through the inner area of the wall so that other people can't reach it.

External dimensions

[Unit : mm(inch)]

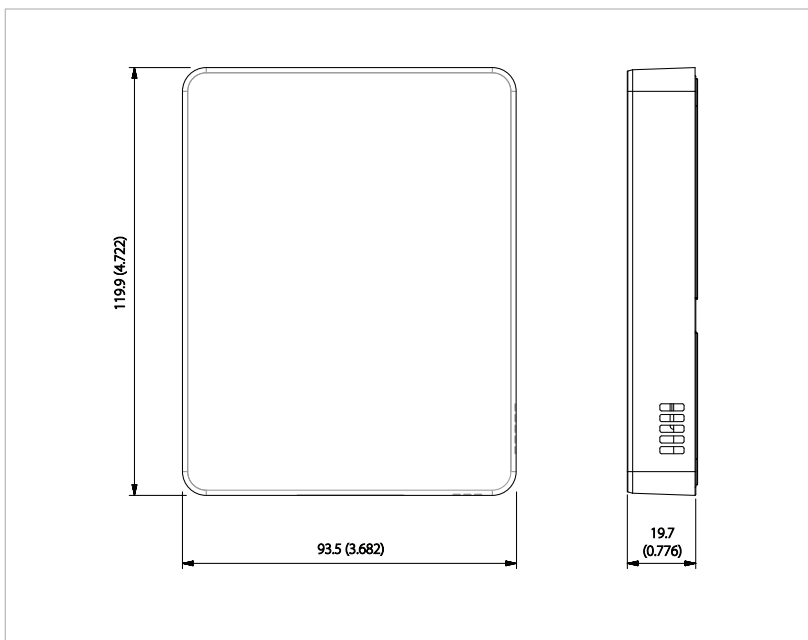

Wired remote controller installation

Wired remote controller installation

1. Insert a small flat head screwdriver into the square groove in the bottom of your wired remote controller, and then pull up the front cover to separate it from the rear cover.

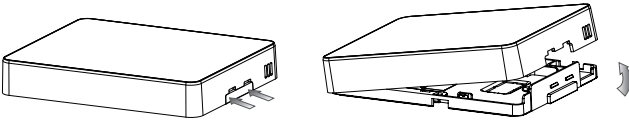

2. Arrange the communication cable so that they fit in the housing along the edges of the rear cover.

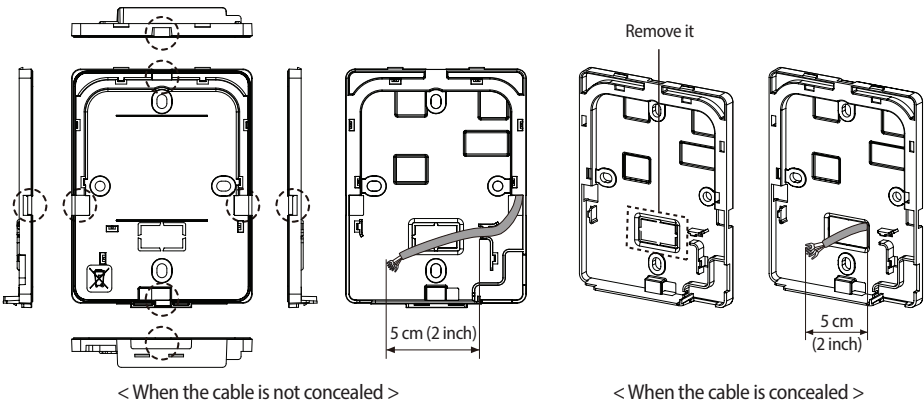

3. Using more than two screws, firmly affix the rear cover of the remote controller to the wall, and then connect the communication and power cable [(F3,F4) or (3, 4)], making sure these cables have reasonable length, to the terminal at the back of the cover.

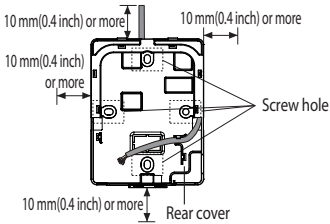

※ Before fixing the rear cover, secure at least 10 mm (0.4 inch) space of upper side, left side, right side, and bottom side.

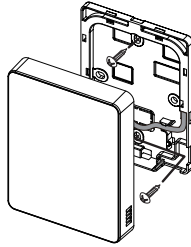

※ You must fit the screws into the screw holes.

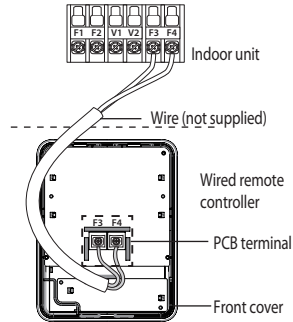

※ Do not tighten the screws on the PCB terminal with excessive force.

4. Reassemble your wired remote controller.



- Align the controller with the upper groove first, and insert it by turning it downward as shown in the figure. After assembly, check and confirm that no wires are stuck in the gap between the rear and front cover.



- When installing a wired remote controller by using a cable longer than 10 m (32.80 ft), you must install the communication cable and the power cable separately. (Electrical interference can cause your wired remote controller to malfunction.)
- When installing your wired remote controller on the wall, consider the size of the wire hole, and select a wire with a proper thickness.
- If you install the wired remote controller by using two pieces of PVC wire, remove the 30 cm (12 inch) of the sheath of the cable and install it only with the two pieces of wires. (Recommended specification: AWG20)
- Maximum distance for connecting communication and power cable : 100 m (328 ft).
- Screws on the PCB terminal must be tightened with less than 6N-cm tightening torque. If the tightening torque is greater, it may damage the screw thread.

Wired remote controller installation

Tracking your indoor unit from the wired remote controller



1. Tracking of your wired remote controller will automatically start when you turn on the power after installation.
2. If you want to perform tracking again after installation, then press the top right corner (hidden button) of the display for more than 7 seconds.
 - The system will reset, and tracking will start again.
3. During tracking, the total number of currently searched indoor units will be displayed.
4. It may take about 3 minutes at initial installation or when you re-set the power master setting.



- If you want to reset the system of your wired remote controller, then press the top right corner (hidden button) of the display for more than 7 seconds.

Individual control with your wired remote controller

Individual control means that you are using one remote controller to control one indoor unit.

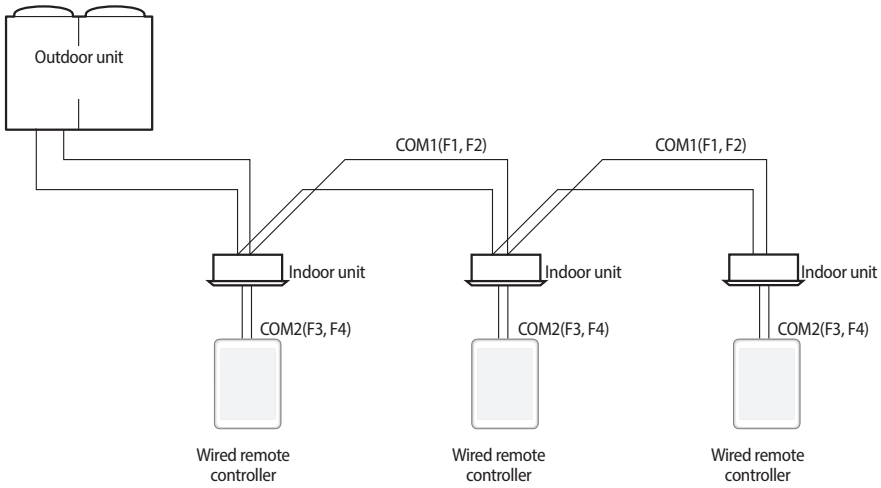

- Regardless of the indoor group address (RMC address) only the indoor unit connected to COM2 is individually controlled.

Wired remote controller installation

Group control with your wired remote controller

Group control means that you are using one wired remote controller to control two or more indoor units at the same time.

1. Using one wired remote controller to control three indoor Units

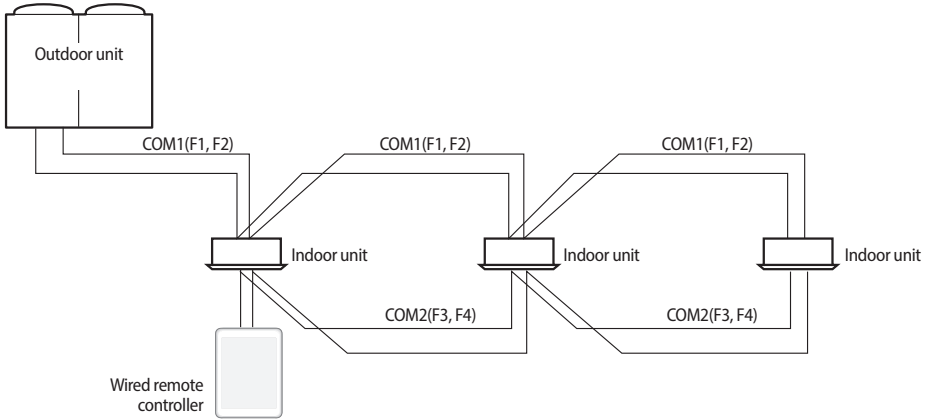

2. Using one wired remote controller to control indoor units connected to different outdoor unit

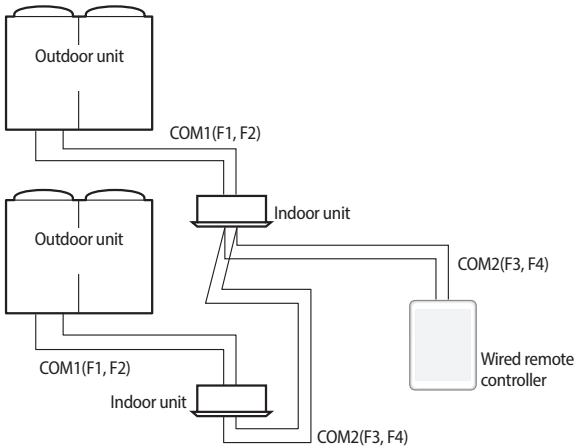

- Regardless of the indoor unit's group address (RMC address), only the indoor units connected to COM2 are controlled in group.
- Regardless of your outdoor units, you can control a maximum of 16 indoor units as a group.
- When controlling group of indoor units connected to different outdoor unit, address of the each outdoor unit must be set differently.

Controlling 2-Remote controller

2-Remote controller is controlling one indoor unit or a group of indoor units with two remote controllers.

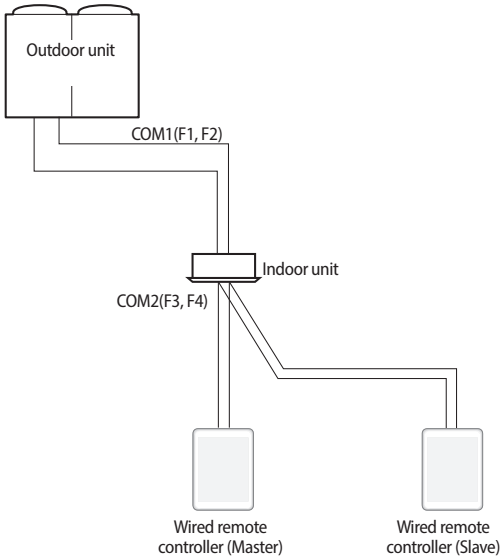

- For the slave wired remote controller settings, please refer to the sections about the additional functions of the wired remote controller. (Refer to 'Additional Functions of your wired remote controller' main menu 1 → sub menu 1, master/slave setting)
- You can only use several functions on the master setting.
 - On-off timer
 - Outing
 - Easy tuning
 - Displays the total number of indoor units
 - Adjust temperature and select mode when relative temperature is displayed



- Wired remote controller without a master/slave setting is properly connected, but If you need to set a specific wired remote controller as a master, you have to set master/slave in the service mode 1-1.

Wired remote controller installation

Initializing your wired remote controller communication

If the number of indoor unit is decreased while you are using your remote control to control one indoor unit or a group of indoor units, then you need to initialize your remote controller communication.

Press the top right corner (hidden button) of the display for more than 7 seconds.

- Your wired remote controller will be initialized, and the device will search for the indoor units connected to your wired remote controller again.

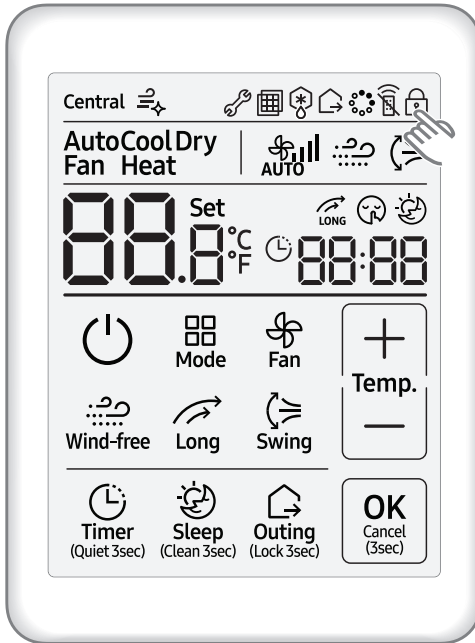

Errors displayed on your wired remote controller

Error codes for the wired remote controller and the indoor units connected to your wired remote controller will be displayed in the LCD display.

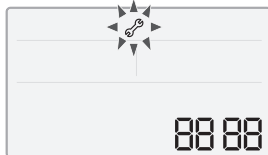

LCD Display

When an error occurs in your indoor/outdoor units (product group display : A)

- The product address for the error will be displayed, followed by the error code.

Example : Error 101 occurs for Indoor Unit no. 10 (decimal digits)

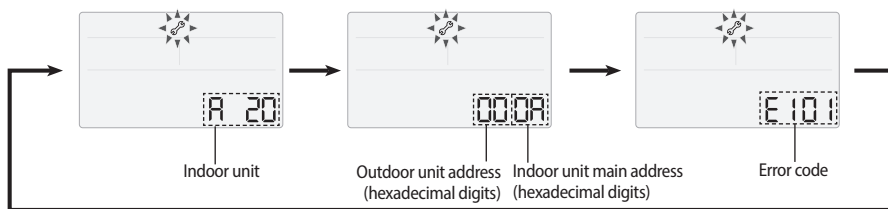

When an error occurs in your wired remote controller

- Only an error code will be displayed. (No address will be displayed.)

Example : Error 601 has occurred at your wired remote controller.

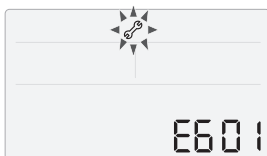

Wired remote controller installation

Wired remote controller error codes

Display	Description
601	Communication error between wired remote controller and indoor units (When communication is lost for over 3 minutes after detecting the indoor unit and the wired remote controller)
602	No communication between Master(Main) and Slave(Sub) wired remote controllers
604	No communication between wired remote controller and indoor units (Including communication error between indoor units and outdoor units)
618	- Exceeded maximum number of indoor unit connection (16 indoor units) - Reset is required after checking the number of indoor units
627	Two or more wired remote controllers set as slave(sub)
653	Temperature sensor open/short error
654	EEPROM error



• For the error codes for your indoor/outdoor units, refer to the installation manual of each device.

Wired remote controller installation/service mode

Additional functions of your wired remote controller

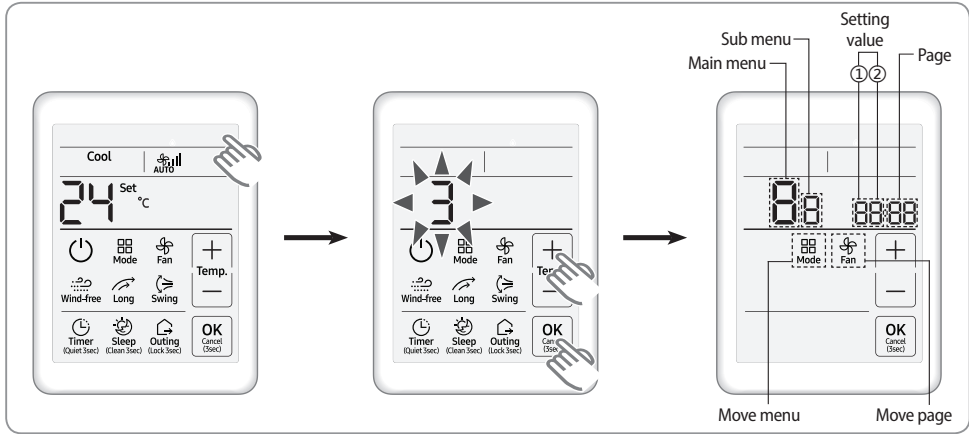

1. If you want to use the various additional functions for your wired remote controller, press the top right corner (hidden button) of the display for more than 3 seconds and drop it. Then you can press [+]/[-] buttons and select No.3 and press [**OK**] button.
 - You will enter the additional function settings, and the main menu will be displayed.
 - If you select the other number and press [**OK**] button, then you can go back to the normal display.
2. Refer to the list of additional functions for your wired remote controller on the next page, and select the desired menu.
 - Using the [+]/[-] buttons, select a main menu number and press the [**Mode**] button to enter the sub-menu setting screen.
 - Using the [+]/[-] buttons, select a sub menu number and press the [**Mode**] button to enter data setting screen.
 - Using the [+]/[-] buttons, select the settings.
 - Press the [**Fan**] button to select page.
 - Press the [**OK**] button to save the current settings. the [**OK**] button is invalid on the main menu or sub menu setting screen.
 - Press the [**Cancel**] button for more than 3 seconds to exit to normal mode without saving settings.

Wired remote controller installation/service mode

Additional functions of your wired remote controller



If communication initialization is needed after the setting, the system will reset automatically and communication will be initialized.

Main menu	Sub menu	Function description		Setting value		Page	Save location
				Value	Factory default		
1	1	Wired remote controller setting/checking (1)	Cooling/Heating selection	0 - Cooling/Heating, 1 - Cooling only	0	01	Wired remote controller
			Use of wireless remote controller for indoor unit	0 - No use, 1 - Use	1	02	Wired remote controller
			Master/Slave wired remote controller	0 - Master, 1 - Slave	0	03	Wired remote controller
			Temperature unit	0 - Celsius(°C), 1 - Fahrenheit(°F)	0	04	Wired remote controller
	2	Wired remote controller setting/checking (2)	Temperature sensor selection	0 - Indoor unit, 1 - Wired remote controller	0	01	Wired remote controller
			Use of average temperature	0 - No use, 1 - Use	0	02	Wired remote controller
			Use of Auto mode	0 - No use, 1 - Use	1	03	Wired remote controller
			Temperature display	0 - Set temperature 1 - Room temperature 2 - Relative temperature 1)*	0	04	Wired remote controller
	5	Room temperature compensation 2)*	Temperature control reference	-9 ~ 40 °C	Current sensor temperature	01	Wired remote controller
			Temperature compensation value	-9.9 ~ 9.9 °C	0	02,03	Wired remote controller
	6	Number of connected units	Number of indoor units	0 ~ 16	0	01	None
	7	Temperature increment/decrement unit (°C only)		0 - 1 °C, 1 - 0.5 °C, 2 - 0.1 °C	0	01	Wired remote controller
	0	Factory option setting		0 - Unchanged, 1 - Factory setting	0	01	None
2	1	Software code		Software code	None	01~03	None
	2	Software version		Software version	None	01~03	None
4	1	Indoor unit address/option setting/checking 3)*	Target address setting	Target address of indoor unit (Example : 20 02 1F)	View master	01~03	None
	2		Main address setting/checking	0~4F (in hexadecimal digits)	Main address of target	01	None
	3		RMC address setting/checking	0x00~0xFE 4)*	RMC address of target	01	None
	4		Basic option setting/checking	Option code	Basic option of target	01~20 5)*	None
	5		Install option setting/checking	Option code	Install option of target	01~20 5)*	None
	6		Install(2) option setting/checking	Option code	Install(2) option of target	01~20 5)*	None
	7		MCU/Port address setting	MCU address (00 to 15) Port address (A to F)	MCU address of target	01~02	None

Main menu	Sub menu	Function description		Setting value		Page	Save location
				Value	Factory default		
5	2	Indoor unit discharge temperature setting/ checking 2)*	Use of discharge temperature control	0 - No use, 1 - Use	0	01	Indoor unit
			Cooling discharge temperature	8~18 °C	15	02	Indoor unit
			Heating discharge temperature	30~43 °C	38	03	Indoor unit
	3	Fresh duct indoor unit discharge temperature setting/ checking 2)*	Cooling discharge temperature	13~25 °C	18	01	Fresh duct indoor unit
			Heating discharge temperature	18~30 °C	25	02	Fresh duct indoor unit
	4	AHU Indoor unit discharge temperature setting/ checking 2)*	Use of discharge temperature control	0 - No use, 1 - Use	0	01	AHU Indoor unit
			Cooling discharge temperature	8~25 °C	15	02	AHU Indoor unit
			Heating discharge temperature	18~43 °C	38	03	AHU Indoor unit
	7	1	View master setting/ checking	Indoor unit view master setting/ checking	Indoor unit view master address (Example : 20 02 1F)	Indoor unit view master	01~03
2		Mode master indoor unit setting/ checking	Mode master indoor unit checking	Indoor unit master address (Example : 20 02 1F)	none	01~03	None
3			Mode master indoor unit setting 6)*	0-No use, 1-Use, 2-Release 7)*	none	01	None
8	1	Status of automatic air volume setting		1	0	01	Indoor unit
	2	Automatic air volume operation		1	0	01	Indoor unit
	3	Automatic air volume voltage setting		1	2	01	Indoor unit
0	1	Reset	Factory setting	1	0		None
	2		Power master reset 8)*	1	0		None
	3		Outdoor units reset	1	0		None

1)* Relative temperature means that the wired remote controller only displays the temperature increase or decrease (± 3) compared to the reference temperature. Reference temperature is determined by other controller's desired temperature setting.

(Example : DMS set 24 °C (75 °F) → 24 °C (75 °F) is reference temperature. Wired remote controller displays it as '0')

2)* Only the celsius temperature unit is allowed when this function setting and checking in the service mode.

For the fahrenheit temperature, you need temperature conversion before this function setting and checking by the celsius temperature unit.

3)* When setting the address/option, you can set the target indoor unit by selecting sub menu 1.

Wired remote controller installation/service mode

4)* RMC(1) : 0~F/RMC(2) : 0~F (hexadecimal digits)

When RMC(1) is set as F, RMC(2) setting is only available up to E. (RMC(1): Group channel, RMC(2): Group address)



Main address of the indoor unit is displayed and entered in hexadecimal digits. Please refer to the following table.

Hexadecimal	Decimal	Hexadecimal	Decimal	Hexadecimal	Decimal	Hexadecimal	Decimal	Hexadecimal	Decimal
00	0	10	16	20	32	30	48	40	64
01	1	11	17	21	33	31	49	41	65
02	2	12	18	22	34	32	50	42	66
03	3	13	19	23	35	33	51	43	67
04	4	14	20	24	36	34	52	44	68
05	5	15	21	25	37	35	53	45	69
06	6	16	22	26	38	36	54	46	70
07	7	17	23	27	39	37	55	47	71
08	8	18	24	28	40	38	56	48	72
09	9	19	25	29	41	39	57	49	73
0A	10	1A	26	2A	42	3A	58	4A	74
0B	11	1B	27	2B	43	3B	59	4B	75
0C	12	1C	28	2C	44	3C	60	4C	76
0D	13	1D	29	2D	45	3D	61	4D	77
0E	14	1E	30	2E	46	3E	62	4E	78
0F	15	1F	31	2F	47	3F	63	4F	79

5)* The total option codes are 24 digits. You can set six digits at a time and it is distinguished by number.

- Press the **[Fan]** button to go to the next page.



- Indoor unit's option setting is from SEG1 to SEG24.
 - SEG1, SEG7, SEG13, SEG19 cannot be set and will not be displayed.
 - SEG2 is a type of option and it cannot be set.
 - Each SEG is displayed in the corresponding page below:
 - .SEG2 ~ SEG6 : Page1 ~ Page5
 - .SEG8 ~ SEG12 : Page6 ~ Page10
 - .SEG14 ~ SEG18 : Page11 ~ Page15
 - .SEG20 ~ SEG24 : Page16 ~ Page20
- Press the **[Fan]** button to go to the next page.

	Page1	Page2	Page3	Page4	Page5		Page6	Page7	Page8	Page9	Page10
SEG1	SEG2	SEG3	SEG4	SEG5	SEG6	SEG7	SEG8	SEG9	SEG10	SEG11	SEG12
0	X	X	X	X	X	1	X	X	X	X	X
	Page11	Page12	Page13	Page14	Page15		Page16	Page17	Page18	Page19	Page20
SEG13	SEG14	SEG15	SEG16	SEG17	SEG18	SEG19	SEG20	SEG21	SEG22	SEG23	SEG24
2	X	X	X	X	X	3	X	X	X	X	X

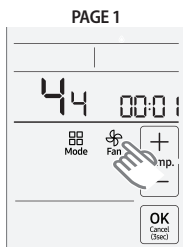

<SEG 2>

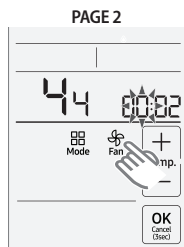

<SEG 3>

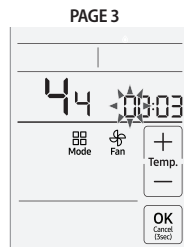

<SEG 4>

6)* Setting is available when there is only 1 indoor unit connection and while the indoor unit operation is not operating.

7)* You can see no.0(no use) and no.1(use) while mode master indoor unit setting.

For the mode master indoor unit setting, select the no.1(use). And you can release the mode master unit setting by selecting the no.2(release).

8)* Power master reset is a setting needed to supply optimized power to wired remote controller when multiple indoor units are connected to wired remote controller in a group.

The example of installation/service mode setting

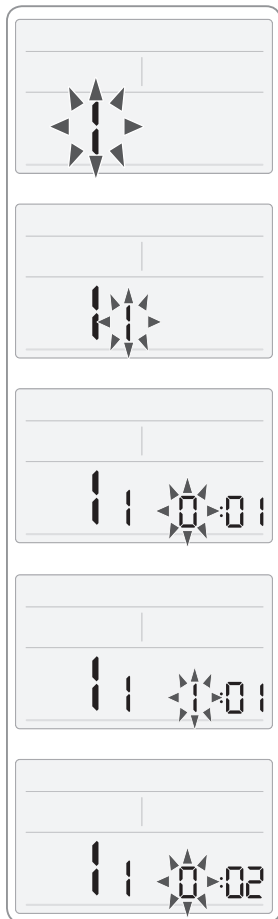

1. Press the top right corner (hidden button) of the display for more than 3 seconds and drop it. Then you can press [+]/[-] buttons and select No.3 and press [**OK**] button.
 - Main menu will be displayed. Press [+]/[-] buttons and select No.1.
2. Press [**Mode**] button to select the number you will set.
 - Press [+]/[-] buttons and select No.1.
3. Press [**Mode**] button to enter the data setting stage.
 - When you enter the setting stage, the current setting value will be displayed.
4. Press [+]/[-] buttons to select No.1
 - The wired remote controller option is set from both cooling and heating to cooling only.
5. Press the [**Fan**] button to select page No.2, then Press [+]/[-] buttons to select No.0
 - The wired remote controller option is set to no use of wireless remote controller.
6. Press the [**OK**] button to save the current settings.
 - Press the [**Cancel**] button for more than three seconds to exit to normal mode without saving settings.

SAMSUNG

