



SYSTEM AIR CONDITIONER

CEILING SERIES

INDOOR UNIT

OUTDOOR UNIT

Model :

AC052MNCDKH
AC071MNCDKH
AC100MNCDKH
AC120MNCDKH
AC140MNCDKH

AC052MXADKH
AC071MXADKH

SERVICE *Manual*

AIR CONDITIONER

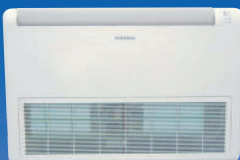

AC052MNCDKH
AC071MNCDKH



AC100MNCDKH
AC120MNCDKH
AC140MNCDKH



AC052MXADKH



AC071MXADKH

CONTENTS

1. Precautions
2. Product Specifications
3. Disassembly and Reassembly
4. Troubleshooting
5. PCB Diagram
6. Wiring Diagram
7. Reference Sheet

Contents

1. Precautions	1-1
1-1 Precautions for the Service.....	1-1
1-2 Precautions related to static electricity and PL.....	1-1
1-3 Precautions related to product safety	1-2
1-4 Other precautions.....	1-2
2. Product Specifications.....	2-1
2-1 The Feature of Product.....	2-1
2-1-1 Features.....	2-1
2-2 Product Specifications	2-2
2-3 Specifications of optional items.....	2-6
3. Disassembly and Reassembly.....	3-1
3-1 Indoor unit	3-2
3-2 Outdoor Unit.....	3-15
4. Troubleshooting	4-1
4-1 Setting Option Setup Method	4-1
4-2 Indoor Display Error and Check Method	4-10
4-3 Troubleshooting for outdoor unit.....	4-13
4-4 Troubleshooting by symptoms.....	4-15
5. PCB Diagram and Parts List.....	5-1
5-1 Indoor Unit.....	5-1
5-2 Outdoor Unit.....	5-4
6. Wiring Diagram	6-1
6-1 Indoor Unit.....	6-1
6-2 Outdoor Unit.....	6-3
7. Reference Sheet	7-1
7-1 Index for Model Name	7-1
7-2 Refrigerating Cycle Diagram	7-2

1. Precautions

1-1 Precautions for the Service

- **Use the standard parts when replacing the electric parts.**
 - Confirm the model name, rated voltage, rated current of the electric parts.
- **When repairing the equipment, connection of the harness parts must be firm and solid.**
 - A loose connection may cause noise or other malfunction.
- **When assembling and disassembling the equipment while it is laid down, lay it on soft cloth.**
 - Otherwise it may scratch the back of the exterior of the product.
- **Remove dust or dirt completely from the housing block, wiring block and service parts during repair.**
 - This helps prevent the danger of fire caused by tracking or short circuit.
- **Fasten the valve caps of service valves and charging valves of outdoor unit as much as possible using adjustable wrenches.**
- **Check the status of the components' assembly after repair service.**
 - The status must be the same as before the repair service.

1-2 Precautions related to static electricity and PL

- **The PCB power supply block is susceptible to static electricity. Therefore, care must be taken during repair or measuring while the power is on.**
 - Wear insulation gloves for PCB repair or measuring.
- **Check whether the installation location is at least two meters away from other electronic products such as TV, video, or audio.**
 - Otherwise, the video quality might be degraded or noise might be generated.
- **Do not let end users repair the products themselves.**
 - Unauthorized disassembly might cause electric shock or fire.

1-3 Precautions related to product safety

- **Do not pull the power cord and do not touch the power plug or aux power switch with wet hands.**
 - It might cause electric shock or fire.
- **A damaged power line or power plug must be replaced to prevent danger.**
- **Do not bend the power cable with excessive force, and do not place a heavy weight on the case as it might damage the cable.**
 - It might cause electric shock or fire.
- **Do not use multiple electric outlets.**
 - This might cause electric shock or fire.
- **Connect the ground terminal when necessary.**
 - You must connect the ground terminal if you determine that there is a danger of electric leakage due to moisture or water.
- **Unplug the power cable or turn off the auxiliary power switch for electric part replacement and repair service.**
 - Otherwise it might cause electric shock.
- **Instruct end users to separate the batteries from the remote controllers and store them separately when the product is not used for long time.**
 - Otherwise leakage from the dry cell may cause problems with the remote controller.

1-4 Other precautions

- **The pipes should have no leaks during installation, and the compressor must be stopped before removing connecting pipes for pump down work. Operating the compressor while the service valve is open and coolant pipe is not properly connected may cause explosion or injury due to abnormal high pressure created inside the coolant cycle as the air can be absorbed through the pipe.**
- **Pump Down work procedure (When uninstalling the product)**
 - Turn on the air conditioner, select cooling operation, and run the compressor for more than three minutes.
 - Release the high pressure and low pressure valve caps.
 - Close the high pressure valve completely using an L-wrench
 - After about two minutes, close the low pressure valve completely.
 - Stop running the air conditioner.
 - Separate the connecting pipe.



2. Product Specifications





2-1 The Feature of Product





2-1-1 Features





- **Auto Changeover**
- **Long Lasting Outdoor Unit**
Anti Corrosion Cabinet & Heat Exchanger are applied.
- **Free Installation**
4 directions piping installation are possible.
- **Various useful functions**
Long piping : Max.30m
- **Eco-friendly Product (Lead-Free, RoHS, WEEE)**

2-2 Product Specifications









ITEM			AC052MNCDKH AC052MXADKH	AC071MNCDKH AC071MXADKH
IMAGE	Indoor Unit			
	Outdoor Unit			
	Remote Controller			
Power	Product		1Φ, 220~240V, 50Hz	1Φ, 220~240V, 50Hz
Indoor	L x H x D	mm(Net)	1000*650*200	1000*650*200
Outdoor	L x H x D	mm(Net)	880*310*638	880*310*798
Indoor	Product		kg(Net)	20.2
Outdoor	Product		kg(Net)	44.5
Capacity	Cooling(STD)		W	5,000
	Heating(STD)		W	6,000
Power Consumption	Cooling(STD)		W	1,640
	Heating(STD)		W	1,780
Operation current	Cooling(STD)		A	7.4
	Heating(STD)		A	7.9
Noise (Cooling/ Heating)	Indoor unit	In case of strongest air blow	dBA	49/49
	Outdoor unit	In case of strongest air blow	dBA	58/58
Refrigerant (R-410A)		g	1,300	1,500
Connecting Pipe	Liquid		mm	6.35
	Gas		mm	12.7
Additional Refrigerant (R-410A)		g/m	10	20
Standard		m	5	5
Extension length(Total)		m	30	50
Extension length(Elevation)		m	20	30
Option Code		Product Option	013077-1950F5-27343C-370020	013077-195591-274750-370020
		Installation Option	020000-100000-200000-300000	020000-100000-200000-300000

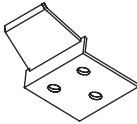

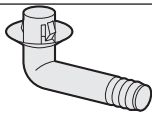

ITEM			AC100MNCDKH AC100MXADKH	AC100MNCDKH AC100MXADNH
IMAGE	Indoor Unit			
	Outdoor Unit		-	-
	Remote Controller			
Power	Product		1Ø, 220~240V, 50Hz	3Ø, 380~415V, 50Hz
Indoor	L x H x D	mm(Net)	1650*675*235	1650*675*235
Outdoor	L x H x D	mm(Net)	940*330*998	940*330*998
Indoor	Product		kg(Net)	42.8
Outdoor	Product		kg(Net)	72
Capacity	Cooling(STD)		W	10,000
	Heating(STD)		W	11,200
Power Consumption	Cooling(STD)		W	3,400
	Heating(STD)		W	3,200
Operation current	Cooling(STD)		A	14.6
	Heating(STD)		A	4.9
Noise (Cooling/ Heating)	Indoor unit	In case of strongest air blow	dBA	50/50
	Outdoor unit	In case of strongest air blow	dBA	58/60
Refrigerant (R-410A)		g	3,000	3,000
Connecting Pipe	Liquid		mm	9.52
	Gas		mm	15.88
Additional Refrigerant (R-410A)		g/m	50	50
Standard		m	5	5
Extension length(Total)		m	50	50
Extension length(Elevation)		m	30	30
Option Code	Product Option		01D07C-1C5439-276470-370040	01D07C-1C5439-276470-370040
	Installation Option		020000-100000-200000-300000	020000-100000-200000-300000

ITEM			AC120MNCDKH AC120MXADKH	AC120MNCDKH AC120MXADNH
IMAGE	Indoor Unit			
	Outdoor Unit		-	-
	Remote Controller			
Power	Product		1Φ, 220~240V, 50Hz	3Φ, 380~415V, 50Hz
Indoor	L x H x D	mm(Net)	1650*675*235	1650*675*235
Outdoor	L x H x D	mm(Net)	940*330*998	940*330*998
Indoor	Product		kg(Net)	42.8
Outdoor	Product		kg(Net)	80
Capacity	Cooling(STD)		W	12,000
	Heating(STD)		W	13,000
Power Consumption	Cooling(STD)		W	4,600
	Heating(STD)		W	3,800
Operation current	Cooling(STD)		A	20.4
	Heating(STD)		A	17.1
Noise (Cooling/ Heating)	Indoor unit	In case of strongest air blow	dB(A)	50/50
	Outdoor unit	In case of strongest air blow	dB(A)	60/64
Refrigerant (R-410A)		g	3,000	3,000
Connecting Pipe	Liquid		mm	9.52
	Gas		mm	15.88
Additional Refrigerant (R-410A)		g/m	50	50
Standard		m	5	5
Extension length(Total)		m	50	50
Extension length(Elevation)		m	30	30
Option Code		Product Option	01D07C-1C247A-277882-370040	01D07C-1C247A-277882-370040
		Installation Option	020000-100000-200000-300000	020000-100000-200000-300000

ITEM			AC140MNCDKH AC140MXADKH	AC140MNCDKH AC140MXADNH
IMAGE	Indoor Unit			
	Outdoor Unit		-	-
	Remote Controller			
Power	Product		1Φ, 220~240V, 50Hz	3Φ, 380~415V, 50Hz
Indoor	L x H x D	mm(Net)	1650*675*235	1650*675*235
Outdoor	L x H x D	mm(Net)	940*330*1210	940*330*1210
Indoor	Product	kg(Net)	42.8	42.8
Outdoor	Product	kg(Net)	85	85
Capacity	Cooling(STD)		W	13,400
	Heating(STD)		W	15,500
Power Consumption	Cooling(STD)		W	4,450
	Heating(STD)		W	4,540
Operation current	Cooling(STD)		A	20
	Heating(STD)		A	19.5
Noise (Cooling/ Heating)	Indoor unit	In case of strongest air blow	dBA	51/51
	Outdoor unit	In case of strongest air blow	dBA	60/62
Refrigerant (R-410A)		g	3,400	3,400
Connecting Pipe	Liquid		mm	9.52
	Gas		mm	15.88
Additional Refrigerant (R-410A)		g/m	50	50
Standard		m	5	5
Extension length(Total)		m	75	75
Extension length(Elevation)		m	30	30
Option Code		Product Option	01D07C-1C54BE-278CA0-370045	01D07C-1C54BE-278CA0-370045
		Installation Option	020000-100000-200000-300000	020000-100000-200000-300000

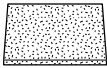
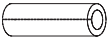
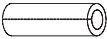
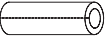
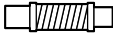
2-3 Accessory

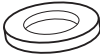
Item	Descriptions	Code-No.	Q'TY	Remark
	USER MANUAL INSTALLATION MANUAL	DB68-06497A DB68-06498A	1	Indoor Unit (AC052/071MNCDKH)
	PLATE WALL	DB61-01351A	2	
	Remote Control	DB93-15882F	1	
	Remote Control Holder	DB61-06087A	1	
	Batteries for Remote Control	4301-000121	2	
	M4 x 16 Tapped Screws	6002-000234	2	
	CARD WARRNATY	DB68-02596B	1	
	RUBBER LEG	DB73-20134A	4	Outdoor unit
	DRAIN PLUG	DB67-20011A	1	
	INSTALLATION MANUAL	DB98-34367A	1	

Item	Descriptions	Code-No.	Q'TY	Remark
	USER MANUAL INSTALLATION MANUAL	DB68-06497A DB68-06498A	1	Indoor Unit (AC100/120/140MNC DKH)
	Insulation	DB62-04318S	1	
	Insu DRAIN HOSE	DB62-11028A	1	
	INSU HOSE D	DB62-11028E	1	
	INSU TUBE OUT	DB62-11028F	1	
	ASSY DRAIN HOSE JOINT	DB67-01191A	1	
	Ass'y Drain Hose Joint	DB90-06701A	1	
	GROMMET-HANGER	DB63-00237A	8	
	CARD WARRNATY	DB68-02596B	1	



3. Disassembly and Reassembly



■ Necessary Tools

Item	Remarks
+SCREW DRIVER	
Adjustable Wrench (8mm, 10mm, 13mm)	
M6, M8 Hex Wrench	

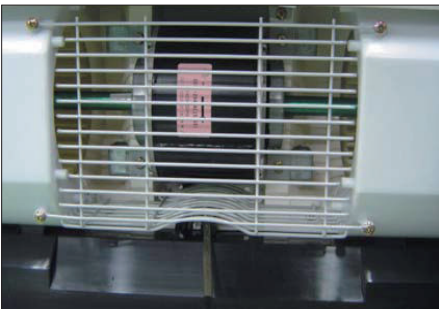

3-1 Indoor Unit

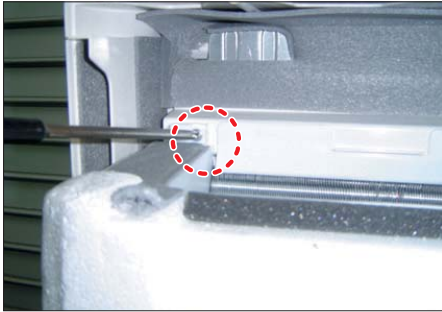
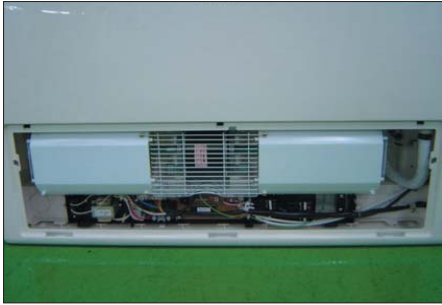

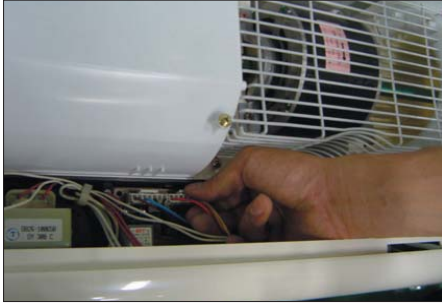
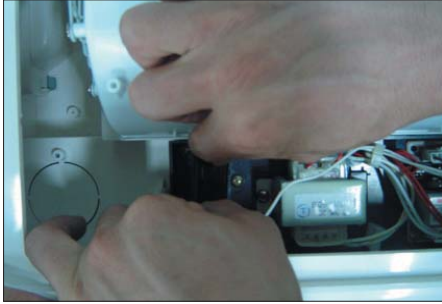

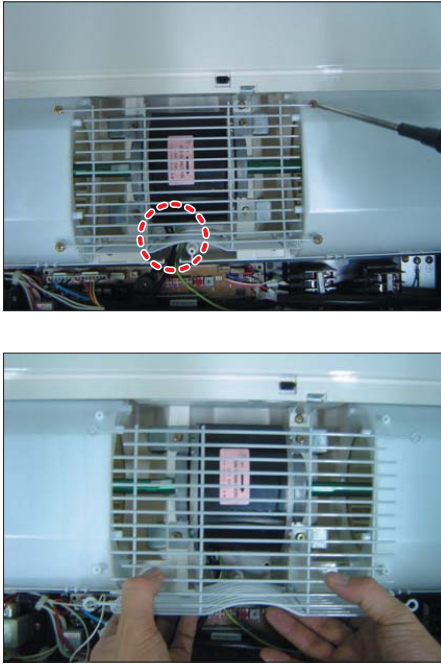
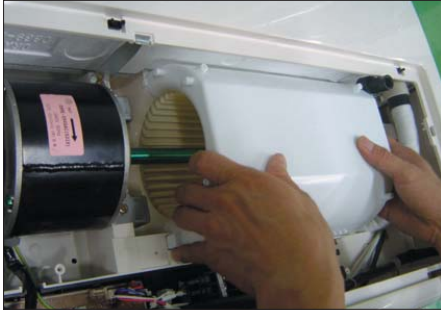
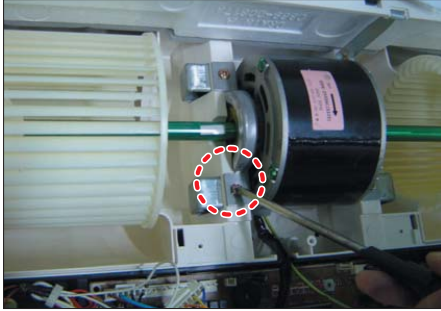
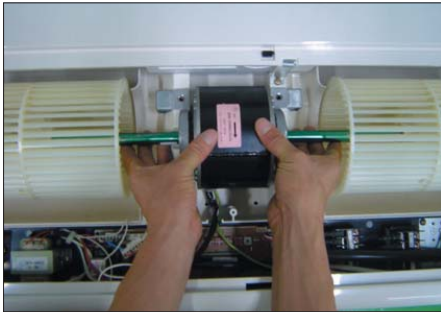
■ AC052MNCDKH/AC071MNCDKH

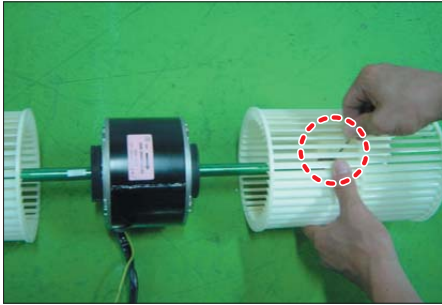
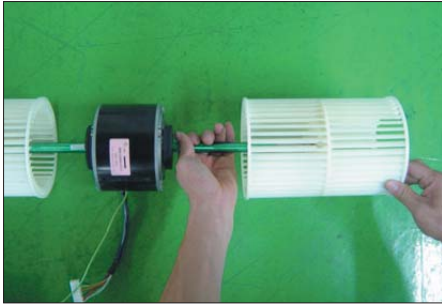
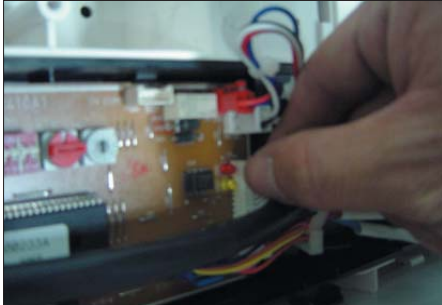

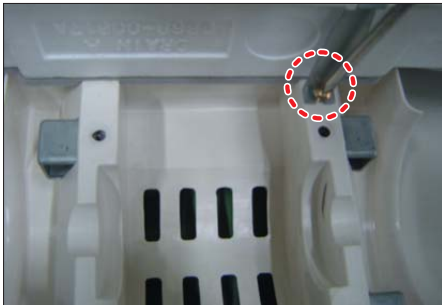
No	Parts	Procedure	Remark
1	Electrical Part	<p>1) Open the Grille by pressing 3 position. (center and both side)</p> <p>2) Detach the Air Inlet Grille.</p> <p>3) Open the Cover of Component Electrical Box by removing 3 screws. (center and both side)</p>	   



No	Parts	Procedure	Remark
			 
2	Fan & Motor	<p>1) Detach the screw and untie earth wire of Motor.</p> <p>2) Disconnect of housing of Motor Wire.</p> <p>3) Disconnect the Capacitor Wire.</p>	  

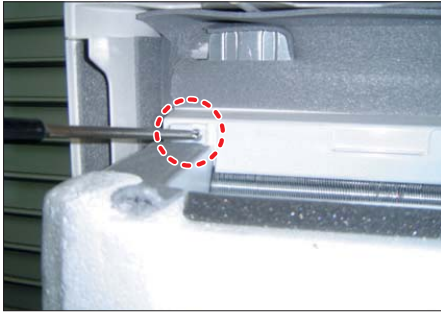

No	Parts	Procedure	Remark
		<p>4) Loosen the Guard Safety by removing 6 screws.</p>	
		<p>5) Detach the Upper Case of Fan. (2EA)</p>	
		<p>6) Loosen the 4 screws what is fix the Motor.</p>	
		<p>7) Detach the Fan and Motor assembly.</p>	

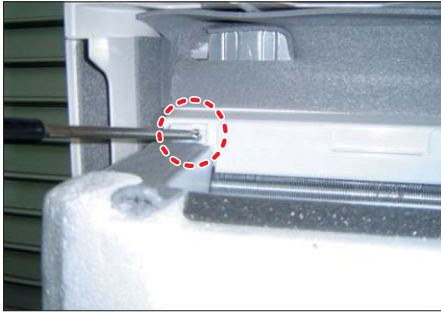
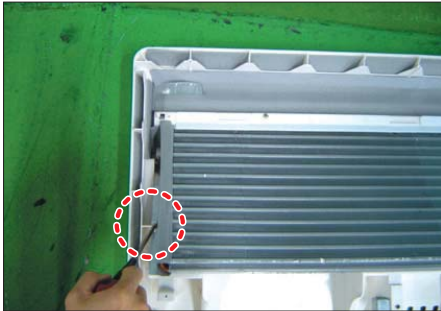
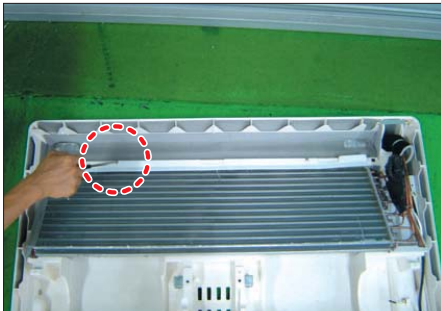
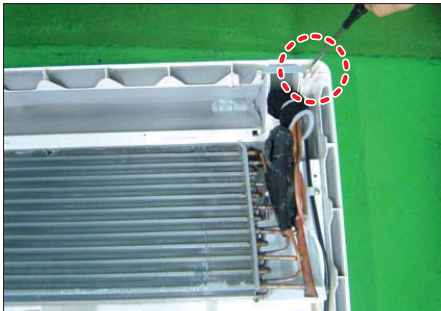

No	Parts	Procedure	Remark
		<p>8) Loosen the set fixing bolts. (with a M3 wrench)</p> <p>9) Detach the Fan.</p>	 
3	Drain Pan	<p>1) Disconnect the Display PCB Wire as shown in picture. (white housing)</p> <p>2) Disconnect the Step Motor Wire as shown in picture. (blue housing)</p> <p>3) Disassemble the Hanger Bracket by removing the 1 screw.</p>	  

No	Parts	Procedure	Remark
		4) Loosen the 3 screws of Front Side.	
		5) Disassemble the assembly Front Cover Part.	
		6) Disconnect the Step Motor Wire as shown in picture.	
		7) Detach the Wire Clamp fixed in Base Part.	
		8) Detach the Front Cover assembly completely.	

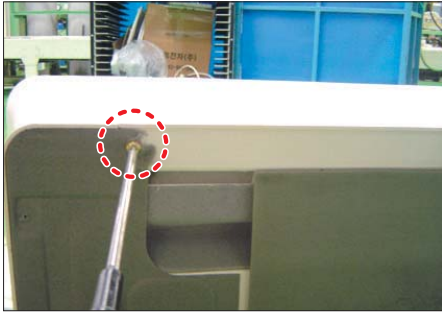
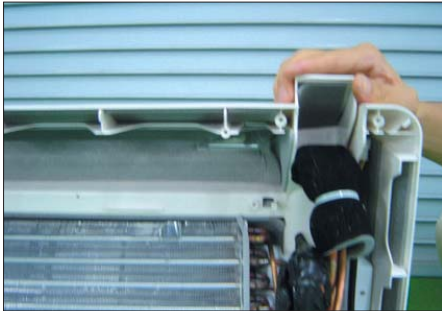
No	Parts	Procedure	Remark
		<p>9) Loosen the screw what is fix with Base Part and Drain Pan. (Upper Side:2EA)</p>	
		<p>10) Loosen the screw what is fix with Base Part and Drain Pan.(Lower Side:2EA)</p>	
		<p>11) Detach the Drain Pan completely.</p>	



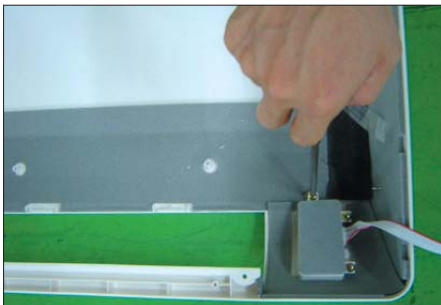
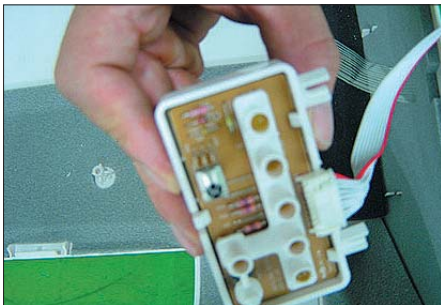

No	Parts	Procedure	Remark
4	Evaporator	<p>1) Disconnect the Thermistor Wire as shown in picture. (white housing)</p> <p>2) Loosen the 2 screws shown in picture.</p> <p>3) Loosen the 2 screws shown in picture and remove Plastic Part. (white)</p> <p>4) Loosen the 2 screws shown in picture and remove Steel Bracket.</p> <p>5) Disassemble the 4 screws Steel Plate in rear side of the unit.</p>	    

No	Parts	Procedure	Remark
		<p>6) Loosen the 2 screws as shown in picture.</p> <p>7) Detach the Plastic Cover as shown in picture.</p> <p>8) Detach the Evaporator assembly.</p>	  

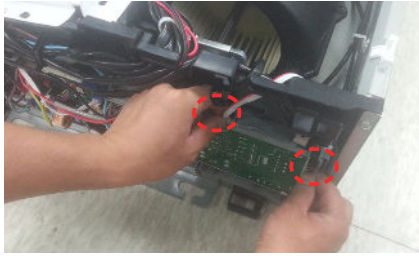
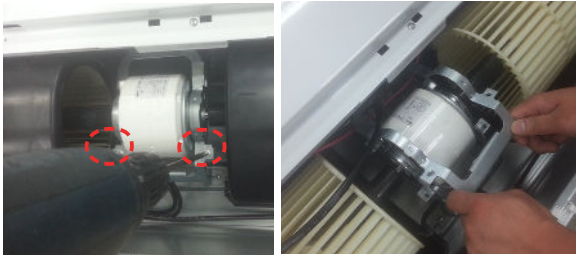

No	Parts	Procedure	Remark
5	Stepping Motor	<p>1) Loosen the 4 screws in rear side of Front Cover assembly as shown in picture.</p> <p>2) Loosen the 2 screws as shown in picture.</p> <p>3) Disassemble the Blade and Stepping Motor assembly and remove the 2 Screws Stepping Motor.</p>	  
6	Display PCB	<p>1) Loosen the 3 screws in rear side of Front Cover assembly as shown in picture.</p> <p>2) Disassemble Display PCB assembly and Disconnect Wire.</p> <p>3) Disassemble the Display PCB.</p>	 

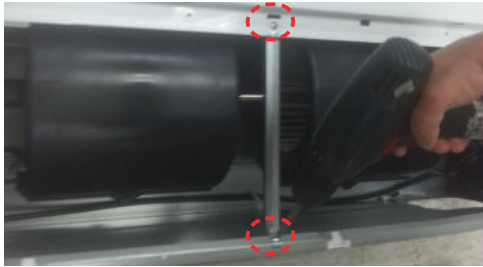
■ AC100MNC DKH/AC120MNC DKH/AC140MNC DKH

No	Parts	Procedure	Remark
1	Electrial Part	<p>⚠ You must turn off the Power before disassembly.</p> <p>1) Open the Grille by sliding 4 position and removing 4 screws.</p> <p>2) Detach the Air Inlet Grille.</p> <p>3) Detach the Cover side by removing 1 screw and sliding Cover.</p> <p>4) Open the cover of Component Electrical Box by removing 2 screws.</p> <p>5) Open the cover of Terminal block Box by removing 2 screws</p>	

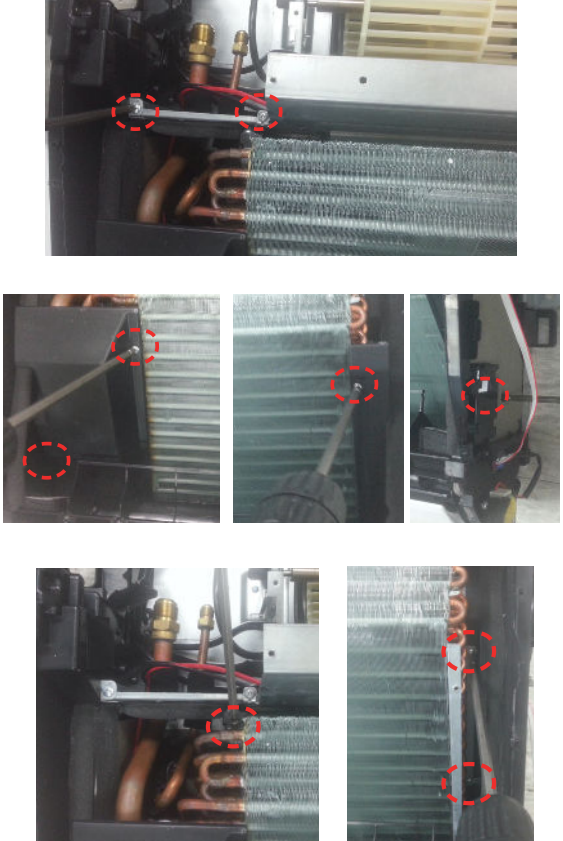
No	Parts	Procedure	Remark
2	Fan & Motor	<p>1) Disconnect 2 wires of Motor.</p> <p>2) Detach Holder Motor by removing 2 screws.</p> <p>3) Detach the Upper case of Fan. (4EA)</p> <p>4) Detach Bracket Grille by removing 2 Screws.</p>	    

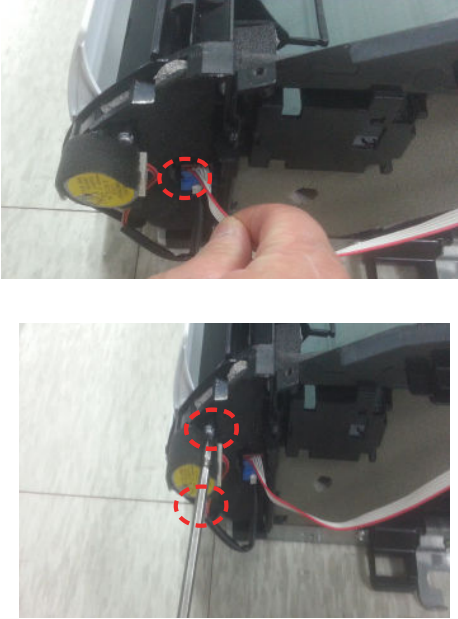

No	Parts	Procedure	Remark
3	Drain Pan	<p>1) Detach the Cabinet Front by removing 7 screws.</p> <p>2) Remove 1 screw in the middle of drain pan.</p> <p>3) Detach the Drian pan. Be careful that there might be some water left in the drain pan when you remove the drain pan.</p>	
4	Evaporator	<p>1) Detache the Cover Pipe by removing 2 screws.</p> <p>2) Detache the Cover Evap LF/RH by removing 4 screws.</p> <p>3) Detach the Evaporator assembly by removing 3 screws.</p>	



No	Parts	Procedure	Remark
5	Stepping Motor	1) Detach the Connector. 2) Detache the Stepping Motor by emoving 2 screws.	
6	Holder Blade	1) Remove 4 screws at both side of the Holder blade.	



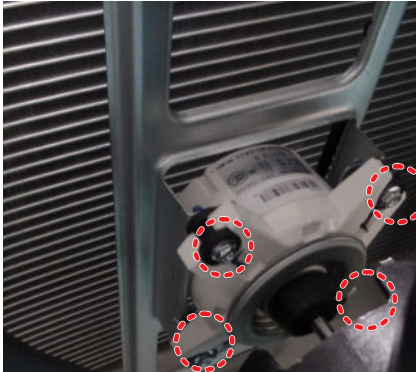

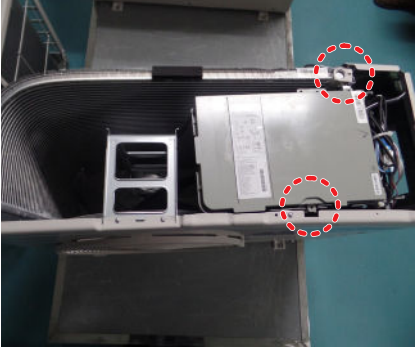
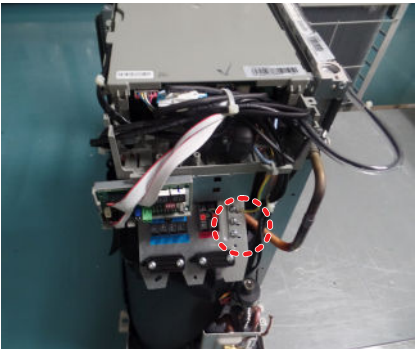
3-2 Outdoor unit

■ AC052MXADKH

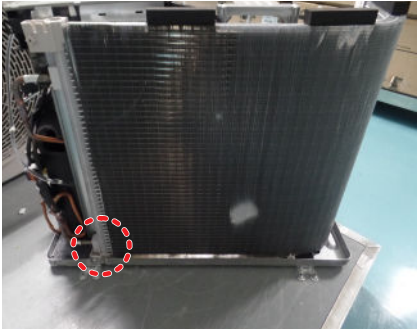
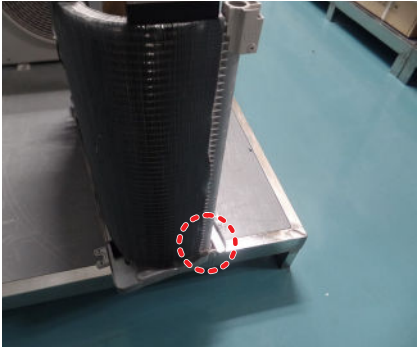

No	Parts	Procedure	Remark
1	common work	<p> You must turn off the Power before disassembly.</p> <p>1) Loosen 1 pcs screw of cover control</p> <p>2) Loosen 8 pcs screw of the cabi top cover.</p> <p>3) Loosen 4 pcs screw of the bar steel.</p> <p>4) Loosen 10 pcs screw of the cabi side front.</p>	   

No	Parts	Procedure	Remark
2		<p data-bbox="485 320 783 349">3) Loosen 4 pcs motor screw.</p> <p data-bbox="485 696 890 725">4) Loosen 2 pcs screw of bracket motor.</p>	 
3	Assy control out	<p data-bbox="485 1084 903 1144">1) Loosen the screws that connected partition and case control then get the control out.</p> <p data-bbox="485 1503 871 1532">2) Loosen the screw of the cover terminal</p>	 

No	Parts	Procedure	Remark
3		<p data-bbox="483 320 906 383">3) Loosen 2 screws , disassemble the Coil Harmonic.</p> <p data-bbox="483 730 911 763">4) Loosen the screw of the cover terminal.</p>	 

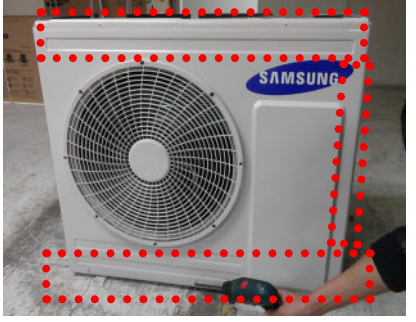
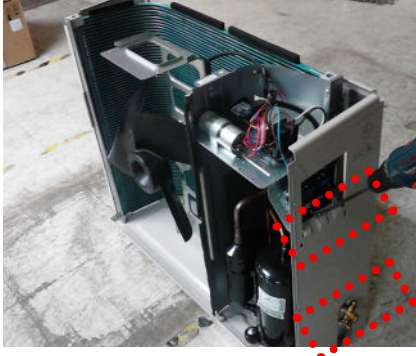

No	Parts	Procedure	Remark
4	Heat exchanger	<p>1) Release the refrigerant at first 2) Loosen fixing screw on both side.. 3) Disassemble the pipes in both inlet and outlet with welding torch. 4) Detach the heat exchanger.</p> <p> When removing the compressor, Heat Exchanger, and Pipe, purge the Coolant inside the Compressor completely and remove the pipe with a welding flame.</p>	  
5	Compressor	1)Loosen the 3 bolts at the bottom of compressor.	

■ AC071MXADKH

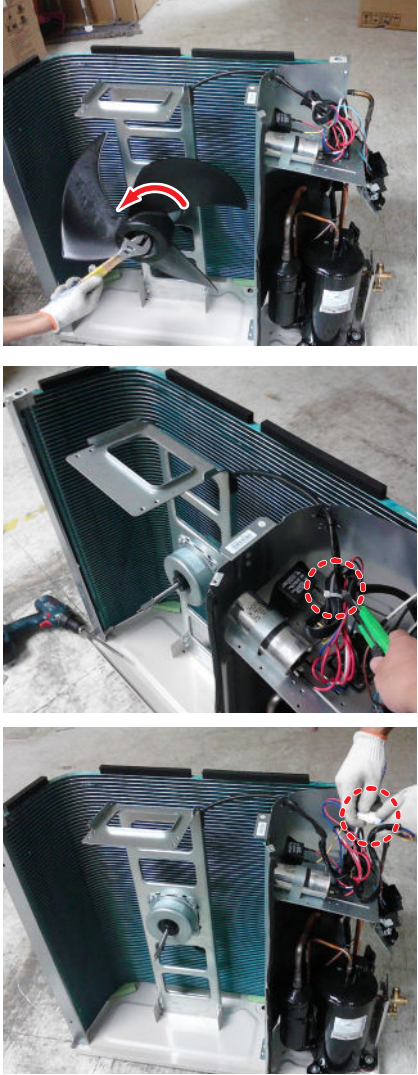
No	Parts	Procedure	Remark
1	common work	<p>1) loosen 1 pcs screw of cover control</p> <p>2) loosen 8 pcs screw of the cabi top cover.</p> <p>3) loosen 12 pcs screw of the cabi front</p> <p>4) loosen 7 pcs screw of the cabi side right.</p>	   

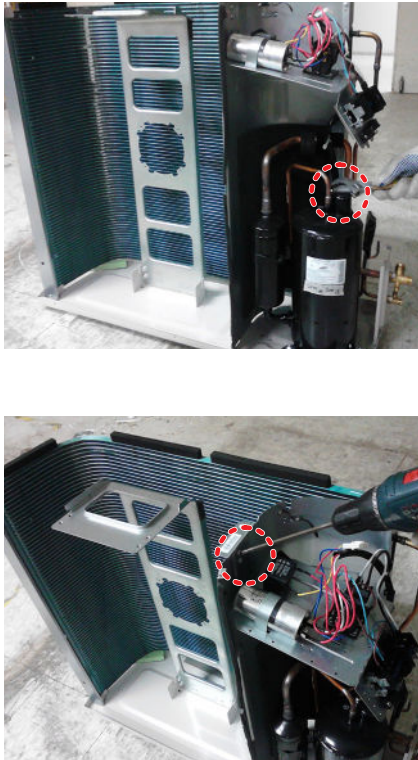
No	Parts	Procedure	Remark
		5)loosen 3pcs screw of the cabi side left.	
2	Fan & Motor	<p>1) loosen the fan screw according the indication and detach the fab propeller</p> <p>2)Cut the cable-tie</p> <p>3)disconnect the wire between assy control out and motor.</p>	

No	Parts	Procedure	Remark
		<p>4) loosen 4 pcs motor screw.</p> <p>5) loosen 4 pcs screw of bracket motor</p>	
3	assy control out	<p>1) loosen the screw of the cover terminal</p> <p>2) loosen the screws that connected partition and case control then pull up the control out.</p>	

No	Parts	Procedure	Remark
4	Heat exchanger	1) Release the refrigerant at first 2) Looosen fixing screw on both side. 3) disassembly the pipes in both inlet and outlet with welding torch. 4) detach the heat exchanger.	
5	Compressor	1)loosen the 3 bolts at the bottom of compressor.	

4. Troubleshooting

4-1 Setting Option Setup Method

You cannot set both of the indoor unit addresses and the installation options in a batch: set both of them respectively.

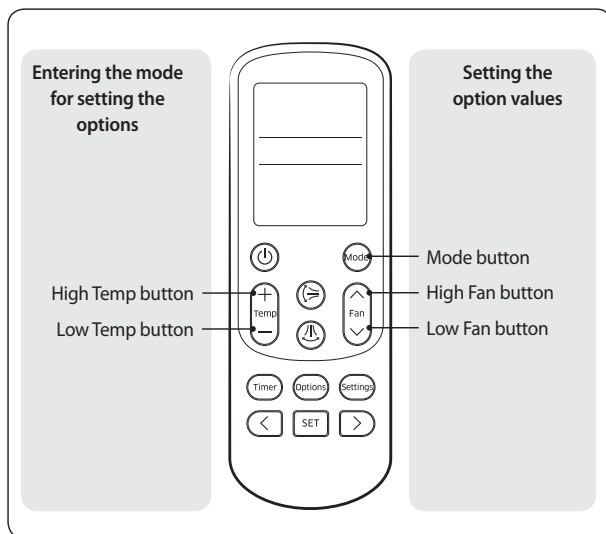

4-1-1 Common steps for setting the addresses and options

MR-EC00 and MR-EH00 remote controls



NOTE

- The remote control display and buttons may vary depending on the model.

- Enter the mode for setting the options:
 - Remove the batteries from the remote control, and then insert them again.
 - While holding down the  (High Temp) and  (Low Temp) buttons simultaneously, insert the batteries into the remote control.
 - Make sure that you are entered to the mode for setting the options:

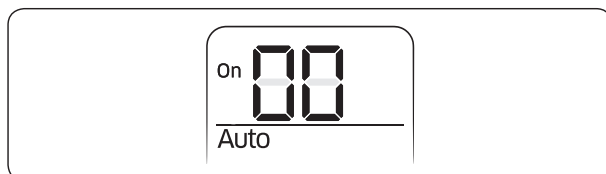



- Set the option values.





















CAUTION

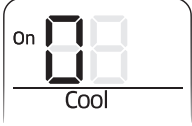
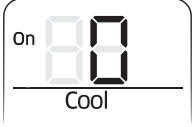







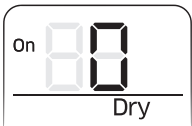

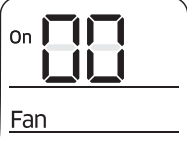

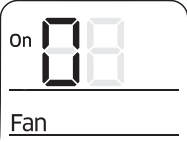
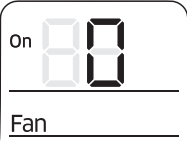

- The total number of available options are 24: SEG1 to SEG24.
- Because SEG1, SEG7, SEG13, and SEG19 are the page options used by the previous remote control models, the modes to set values for these options are skipped automatically.
- Set a 2-digit value for each option pair in the following order: SEG2 and SEG3 \boxtimes SEG4 and SEG5 \boxtimes SEG6 and SEG8 \boxtimes SEG9 and SEG10 \boxtimes SEG11 and SEG12 \boxtimes SEG14 and SEG15 \boxtimes SEG16 and SEG17 \boxtimes SEG18 and SEG20 \boxtimes SEG21 and SEG22 \boxtimes SEG23 and SEG24

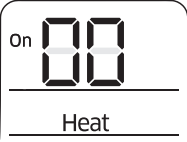



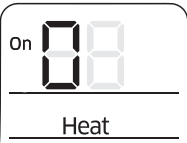
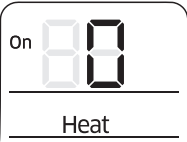



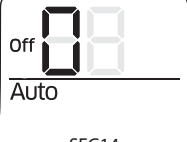





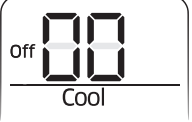

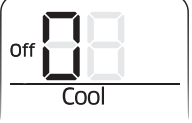
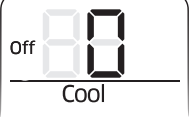

SEG1	SEG2	SEG3	SEG4	SEG5	SEG6
0	X	X	X	X	X
SEG7	SEG8	SEG9	SEG10	SEG11	SEG12
1	X	X	X	X	X
SEG13	SEG14	SEG15	SEG16	SEG17	SEG18
2	X	X	X	X	X
SEG19	SEG20	SEG21	SEG22	SEG23	SEG24
3	X	X	X	X	X







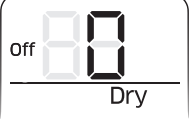

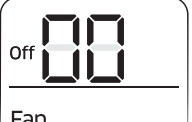

On (SEG1 to SEG12)	Off (SEG13 to SEG24)
	

Take the steps presented in the following table:

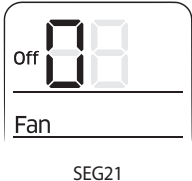
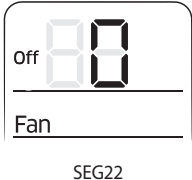
Steps	Remote control display
<p>1 Set the SEG2 and SEG3 values:</p> <p>a Set the SEG2 value by pressing the  (Low Fan) button repeatedly until the value you want to set appears on the remote control display.</p> <p>b Set the SEG3 value by pressing the  (High Fan) button repeatedly until the value you want to set appears on the remote control display.</p> <p>When you press the  (Low Fan) or  (High Fan) button, values appear in the following order: 0 → 1 → ... E → F</p>	 <p style="text-align: center;">SEG2</p>  <p style="text-align: center;">SEG3</p>
<p>2 Press the  (Mode) button. Cool and On appear on the remote control display.</p>	
<p>3 Set the SEG4 and SEG5 values:</p> <p>a Set the SEG4 value by pressing the  (Low Fan) button repeatedly until the value you want to set appears on the remote control display.</p> <p>b Set the SEG5 value by pressing the  (High Fan) button repeatedly until the value you want to set appears on the remote control display.</p> <p>When you press the  (Low Fan) or  (High Fan) button, values appear in the following order: 0 → 1 → ... E → F</p>	 <p style="text-align: center;">SEG4</p>  <p style="text-align: center;">SEG5</p>
<p>4 Press the  (Mode) button. Dry and On appear on the remote control display.</p>	
<p>5 Set the SEG6 and SEG8 values:</p> <p>a Set the SEG6 value by pressing the  (Low Fan) button repeatedly until the value you want to set appears on the remote control display.</p> <p>b Set the SEG8 value by pressing the  (High Fan) button repeatedly until the value you want to set appears on the remote control display.</p> <p>When you press the  (Low Fan) or  (High Fan) button, values appear in the following order: 0 → 1 → ... E → F</p>	 <p style="text-align: center;">SEG6</p>  <p style="text-align: center;">SEG8</p>

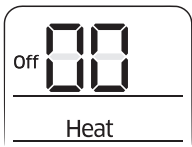
Steps	Remote control display
<p>6 Press the  (Mode) button. Fan and On appear on the remote control display.</p>	
<p>7 Set the SEG9 and SEG10 values:</p> <p>a Set the SEG9 value by pressing the  (Low Fan) button repeatedly until the value you want to set appears on the remote control display.</p> <p>b Set the SEG10 value by pressing the  (High Fan) button repeatedly until the value you want to set appears on the remote control display.</p> <p>When you press the  (Low Fan) or  (High Fan) button, values appear in the following order: 0 → 1 → ... E → F</p>	 <p style="text-align: center;">SEG9</p>  <p style="text-align: center;">SEG10</p>
<p>8 Press the  (Mode) button. Heat and On appear on the remote control display.</p>	
<p>9 Set the SEG11 and SEG12 values:</p> <p>a Set the SEG11 value by pressing the  (Low Fan) button repeatedly until the value you want to set appears on the remote control display.</p> <p>b Set the SEG12 value by pressing the  (High Fan) button repeatedly until the value you want to set appears on the remote control display.</p> <p>When you press the  (Low Fan) or  (High Fan) button, values appear in the following order: 0 → 1 → ... E → F</p>	 <p style="text-align: center;">SEG11</p>  <p style="text-align: center;">SEG12</p>
<p>10 Press the  (Mode) button. Auto and Off appear on the remote control display.</p>	
<p>11 Set the SEG14 and SEG15 values:</p> <p>a Set the SEG14 value by pressing the  (Low Fan) button repeatedly until the value you want to set appears on the remote control display.</p>	 <p style="text-align: center;">SEG14</p>

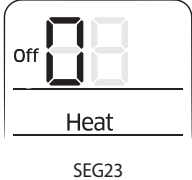
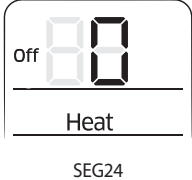

Steps	Remote control display
<p>b Set the SEG15 value by pressing the  (High Fan) button repeatedly until the value you want to set appears on the remote control display.</p> <p>When you press the  (Low Fan) or  (High Fan) button, values appear in the following order: 0 → 1 → ... E → F</p>	 <p style="text-align: center;">SEG15</p>
<p>1 Press the  (Mode) button. Cool and Off appear on the remote control display.</p>	
<p>2 Set the SEG16 and SEG17 values:</p> <p>a Set the SEG16 value by pressing the  (Low Fan) button repeatedly until the value you want to set appears on the remote control display.</p> <p>b Set the SEG17 value by pressing the  (High Fan) button repeatedly until the value you want to set appears on the remote control display.</p> <p>When you press the  (Low Fan) or  (High Fan) button, values appear in the following order: 0 → 1 → ... E → F</p>	 <p style="text-align: center;">SEG16</p>  <p style="text-align: center;">SEG17</p>
<p>3 Press the  (Mode) button. Dry and Off appear on the remote control display.</p>	
<p>4 Set the SEG18 and SEG20 values:</p> <p>a Set the SEG18 value by pressing the  (Low Fan) button repeatedly until the value you want to set appears on the remote control display.</p> <p>b Set the SEG20 value by pressing the  (High Fan) button repeatedly until the value you want to set appears on the remote control display.</p> <p>When you press the  (Low Fan) or  (High Fan) button, values appear in the following order: 0 → 1 → ... E → F</p>	 <p style="text-align: center;">SEG18</p>  <p style="text-align: center;">SEG20</p>
<p>5 Press the  (Mode) button. Fan and Off appear on the remote control display.</p>	

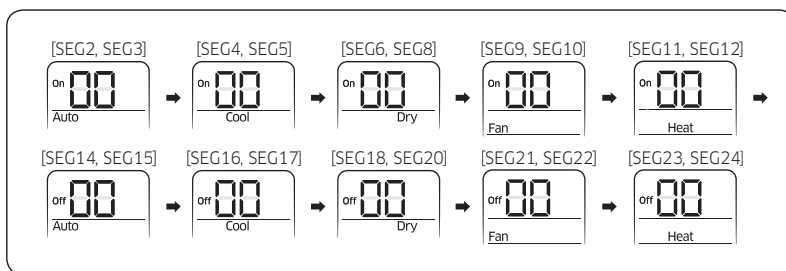

Steps	Remote control display
<p>6 Set the SEG21 and SEG22 values:</p> <p>a Set the SEG21 value by pressing the  (Low Fan) button repeatedly until the value you want to set appears on the remote control display.</p> <p>b Set the SEG22 value by pressing the  (High Fan) button repeatedly until the value you want to set appears on the remote control display.</p> <p>When you press the  (Low Fan) or  (High Fan) button, values appear in the following order: 0 → 1 → ... E → F</p>	 
<p>7 Press the  (Mode) button. Heat and Off appear on the remote control display.</p>	
<p>8 Set the SEG23 and SEG24 values:</p> <p>a Set the SEG23 value by pressing the  (Low Fan) button repeatedly until the value you want to set appears on the remote control display.</p> <p>b Set the SEG24 value by pressing the  (High Fan) button repeatedly until the value you want to set appears on the remote control display.</p> <p>When you press the  (Low Fan) or  (High Fan) button, values appear in the following order: 0 → 1 → ... E → F</p>	 

3 Check whether the option values that you have set are correct by pressing the  (Mode) button repeatedly



4 Save the option values into the indoor unit:

Point the remote control to the remote control sensor on the indoor unit and then press the  (Power) button on the remote control twice. Make sure that this command is received by the indoor unit. When it is successfully received, you can hear a short sound from the indoor unit. If the command is not received, press the  (Power) button again.

- 1 Check whether the air conditioner operates in accordance with the option values you have set:
 - a Reset the indoor or outdoor unit.
 - Indoor unit : Press the  (Set) and  (Low Fan) buttons on the remote control simultaneously for 4 seconds.
 - Outdoor unit : Press the K3 button.
 - b Remove the batteries from the remote control, insert them again, and then press the  (Power) button on the remote control.

4-1-2 Setting the indoor unit addresses

Option No. for an indoor unit address: 0AXXXX-1XXXXX-2XXXXX-3XXXXX

Before installing an indoor unit, be sure to set an address for the indoor unit by taking the following steps:

- 1 Make sure that the power is supplied to the indoor unit. If the indoor unit is not plugged in, it must include a power supply.

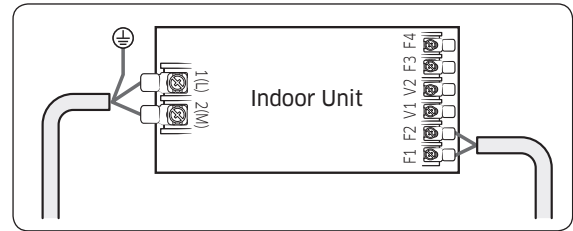

- 2 Set an address for each indoor unit using the remote control, according to your air conditioning system plan, by referring to the following table and by following the steps in **Common steps for setting the addresses and options** on page <?>.
 - The indoor unit addresses (main and RMC addresses) are set to 0A0000-100000-200000-300000 by default.
 - If indoor units and outdoor units match 1:1, you don't need to set the main address because it is automatically set by the outdoor unit.
 - If you are using on or off controller, set RMC address.

Option	SEG1		SEG2		SEG3		SEG4	SEG5		SEG6	
Function	Page		Mode		Setting main address		Reserved	Reserved		Indoor unit number	
Indication and details	Indication	Details	Indication	Details	Indication	Details				Indication	Details
	0		A		0	No main address				0 to 9	Units digit
					1	Main address setting mode					
Option	SEG7		SEG8		SEG9		SEG10	SEG11		SEG12	
Function	Page		Reserved		Setting RMC address		Reserved	Group channel (x16)		Group address	
Indication and details	Indication	Details			Indication	Details		Indication	Details	Indication	Details
	1				0	No RMC address		RMC1	0 to 2	RMC2	0 to F
			1	RMC address setting mode							

CAUTION

- The main address must be set to a value in the range 0 to 14. If you set other values, communication error will occur.
- If any of SEG5 and SEG6 is set to a value in the range A to F, the main address of the indoor unit does not change.
- If SEG3 is set to 0, the indoor unit maintains the existing main address even if SEG6 is set to a new value.
- If SEG9 is set 0, the indoor unit maintains the existing RMC address even if SEG11 and SET12 are set to new values.

4-1-3 Setting the installation options in a batch

Option No. for an indoor unit address: 02XXXX-1XXXXX-2XXXXX-3XXXXX

- 1 Make sure that the power is supplied to the indoor unit. If the indoor unit is not plugged in, it must include a power supply.

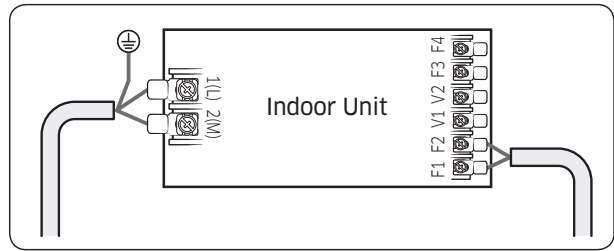

- 2 Set the installation options of indoor units, by referring to the following table and by following the steps in **Common steps for setting the addresses and options** on page <?>.
 - The installation options of indoor units are set to 020000-100000-200000-300000 by default.
 - The SEG20 option, Individual control with remote control, allows you to control multiple indoor units individually by using the remote control.

Option	SEG1		SEG2		SEG3	SEG4		SEG5		SEG6	
Function	Page		Mode		Reserved	Use of external temperature sensor		Use of central control		Compensation of the fan RPM	
Indication and details	Indication	Details	Indication	Details		Indication	Details	Indication	Details	Indication	Details
	0			2			0	Disuse	0	Disuse	0
										1	High-ceiling mode (recessed installation)
						1	Use	1	Use	4	Disuse (exposed installation)
										5	High-ceiling mode (exposed installation)

Option	SEG7		SEG8		SEG9		SEG10		SEG11		SEG12	
Function	Page		Use of drain pump									
Indication and details	Indication	Details	Indication	Details	Reserved		Reserved		Reserved		Reserved	
	1		0	Disuse								
			1	Use								
2	Use with 3 minute delay											
Option	SEG13		SEG14		SEG15		SEG16		SEG17		SEG18	
Function	Page		Use of external control		Setting the output of external control		S-Plasma ion		Buzzer control		Maximum filter usage time	
Indication and details	Indication	Details	Indication	Details	Indication	Details	Indication	Details	Indication	Details	Indication	Details
	2		0	Disuse	0	Thermo on	0	Disuse	0	Use of buzzer	2	1000 hours
			1	On/Off control								
			2	Off control								
			3	Window on/off control								
	2		4	Disuse	1	Operation on	1	Use	1	Disuse of buzzer	6	2000 hours
			5	On/Off control								
			6	Off control								
7			Window on/off control									
Option	SEG19		SEG20		SEG21		SEG22		SEG23		SEG24	
Function	Page		Individual control with remote control		Heating setting compensation						Cycle time of Swing	
Indication and details	Indication	Details	Indication	Details	Indication	Details	Reserved		Reserved		Indication	Details
	3		0 or 1	Indoor 1	0	Default					0	34 seconds (default)
			2	Indoor 2	1	2°C					1	30 seconds
			3	Indoor 3	2	5°C					2	38 seconds
4			Indoor 4									

- Even if you set the Use of drain pump (SEG8) option to 0, it is automatically set to 2 (the drain pump is used with 3 minute delay).
- If you set the Maximum filter usage time (SEG18) option to a value other than 2 and 6, it is automatically set to 2 (1000 hours).
- If you set the Individual control with remote control (SEG20) option to a value other than 0 to 4, it is automatically set to 0 (Indoor 1).
- Default value of Heating setting compensation (SEG21) is 5°C for 360 cassette model.

* Level control: The centralized controller can limit the functions and inputs of connected products with this function enabled. (Example: Operation mode limit (Cooling only/Heating only/No limitation), Heating temperature upper limit, Cooling temperature lower limit)
 To enable 'Level control' when applying the DPM with the centralized controller, appoint the master (Set 'Use of external control [SEG14] option to 4 or higher).

Example: When installing DPM (1 Outdoor unit with 4 indoor units)

Condition		SEG14 Setting				Result
External control	Level control	Indoor 1	Indoor 2	Indoor 3	Indoor 4	
Default		Not set (0)				Slave (All)
Disuse	Use	4	Not set (0)	Not set (0)	Not set (0)	Master (Indoor 1), Slave (Indoor 2,3,4)
Use (Indoor 3)	Disuse	Not set (0)	Not set (0)	1~3	Not set (0)	Slave (All)
Use (Indoor 4)	Use	Not set (0)	Not set (0)	Not set (0)	5~7	Master (Indoor 4), Slave (Indoor 1,2,3)

4-1-4 Changing the addresses and options individually

When you want to change the value of a specific option, refer to the following table and follow the steps in **Common steps for setting the addresses and options** on page <?>.

Option	SEG1		SEG2		SEG3		SEG4		SEG5		SEG6	
Function	Page		Mode		Option mode to change		Tens position of the option number		Units position of the option number		New value	
Indication and details	Indication	Details	Indication	Details	Indication	Details	Indication	Details	Indication	Details	Indication	Details
		0		D		Option type	0 to F	Tens position value	0 to 9	Units position value	0 to 9	New value

Example: Changing the Buzzer control (SEG17) option of the installation options to 1 disuse.





Option	SEG1	SEG2	SEG3	SEG4	SEG5	SEG6
Function	Page	Mode	Option mode to change	Tens position of the option number	Units position of the option number	New value
Indication	0	D	2	1	7	1

4-2 Indoor Display Error and Check Method

- If an error occurs during the operation, one or more LED flickers and the operation is stopped except the LED.
- If you re-operate the air conditioner, it operates normally at first, then detect an error again.

LED Display on the indoor unit

AC052/071MNCDKH

Abnormal conditions	Indicators					Remarks
						
Power reset	●	X	X	X	X	
Error of temperature sensor in indoor unit (OPEN/SHORT)	X	X	●	X	X	Displayed on appropriate indoor unit which is operating
Error of the indoor unit pipe sensor	●	X	●	X	X	Displayed on appropriate indoor unit which is operating
Error of the outdoor unit pipe sensor	●	X	X	●	X	Displayed on appropriate indoor unit which is operating Displayed on outdoor unit
Communication error (Transmitter, wired remote control)	X	X	●	●	X	Error of indoor unit: Displayed on the indoor unit regardless of operation
Communication error between indoor units	●	X	X	X	●	Error of outdoor unit: Displayed on the indoor unit which is operating
Error of peripherals option set-up	X	X	●	X	●	
EEPROM error	●	X	●	●	X	
EEPROM option error	●	●	●	●	●	
High pressure blockage error (Refrigerant completely Leakage error)	●	X	X	●	●	
Error of outdoor Unit/Self-Diagnosis(Check error code in outdoor unit or solution display or thermal fuse on Indoor's POWER T/B(open))	X	X	●	●	●	

● : On, ● : Blinking, X : Off

- If you turn off the air conditioner when the LED is flickering, the LED is also turned off.
- If you re-operate the air conditioner, it operates normally at first, then detects an error again.

AC100/120/140MNC DKH

Abnormal conditions	Indicators				Remarks
	Blue	Green	Orange	Red	
Power reset	●	X	X	X	0.5[S]=On, 0.5[S]=Off
Operation on	●	X	X	X	
Operation off	X	X	X	X	
Reservation	X	●	X	X	
Filter sign	X	X	●	X	
Defrosting	●	X	X	X	1[S]=On, 9[S]=Off
Smart install Error	X	X	X	●	
Communication error between indoor units	X	●	X	X	
EEPROM error /EEPROM option error	●	X	X	●	
Error of temperature sensor in indoor unit (open/short)	X	X	X	●	
Error of outdoor Unit/Self-Diagnosis	X	X	●	X	
Error of the indoor unit pipe sensor	X	●	X	●	
High pressure blockage error	X	X	●	X	
Indoor fan error	●	●	X	X	
Thermal fuse open error	●	X	●	X	
Indoor unit float S/W 2nd detection	X	●	●	X	

● : On, ● : Blinking, X : Off

- If you turn off the air conditioner when the LED is flickering, the LED is also turned off.
- If you re-operate the air conditioner, it operates normally at first, then detects an error again.
- If the LED displays only one color, it is turned on for a second and turned off for a second.
- If the LED displays more than two colors, each color is shown for a second alternately.

Wired remote control

- If an error occurs,  is displayed on the wired remote control.
- If you would like to see an error code, press the Test button.

Display	Explanation
E108	Error due to repeated communication address
E121	Error on room temperature sensor of indoor unit (Short or Open)
E122	Error on EVA IN sensor of indoor unit (Short or Open)
E123	Error on EVA OUT sensor of indoor unit (Short or Open)
E153	Error on float switch (2nd detection)
E154	Indoor fan error
E198	Error on thermal fuse of indoor unit (Open)
E201	Communication error between indoor unit and outdoor unit (Pre tracking failure or when actual number of indoor units are different from the indoor unit quantity setting on the outdoor unit) Error due to communication tracking failure after initial power is supplied.
E202	Communication error between indoor unit and outdoor unit (When there is no response from indoor units after tracking is completed)
E203	Communication error between outdoor unit inv - main micom (For PF #4~#6 controller, error will be determined from the time when compressor is turned on)
E221	Error on outdoor temperature sensor (Short or Open)
E231	Error on outdoor COND OUT sensor (Short or Open)
E251	Error on discharge temperature sensor of compressor 1 (Short or Open)
E320	Error on OLP sensor (Short or Open)
E403	Compressor down due to freeze protection control
E404	System stop due to overload protection control
E416	System stop due to discharge temperature
E422	Blockage detected on high pressure pipe
E425	Reverse phase or open phase
E440	Heating operation restricted at outdoor temperature over Theat_high value (default: 30 °C)
E441	Cooling operation restricted at outdoor temperature below Tcool_low value (default: 0 °C)
E458	Fan speed error

4-3 Troubleshooting for outdoor unit

The table below list the self-diagnostic routines. For some of error codes, you must contact an authorized service centre. If an error occurs during the operation, it is displayed on the outdoor unit PCB LED, both MAIN PCB and INVERTER PCB.

No.	Error Code	Meaning	Remarks
1	E108	Error due to duplicated communication address	Check on repeated indoor unit main address
2	E121	Error on room temperature sensor of indoor unit (Short or Open)	Indoor unit Room Thermistor Open/Short
3	E122	Error on EVA IN sensor of indoor unit (Short or Open)	Indoor unit EVA_IN Thermistor Open/Short
4	E123	Error on EVA OUT sensor of indoor unit (Short or Open)	Indoor unit EVA_OUT Thermistor Open/Short
5	E153	Error on float switch (2nd detection)	Indoor unit Float Switch Open/Short Drain Pump operation Check
6	E154	Indoor fan error	Check on indoor unit indoor Fan operation
7	E198	Error on thermal fuse of indoor unit (Open)	Thermal Fuse Open Check of indoor unit Terminal Block
8	E201	Communication error between the indoor unit and outdoor unit (Pre-tracking failure or when the actual number of indoor units are different from the indoor unit quantity setting on the outdoor unit) Error due to communication tracking failure after initial power is supplied (The error occurs regardless of the number of units.)	Check indoor quantity setting in outdoor
9	E202	Communication error between indoor unit and outdoor unit (When there is no response from indoor units after tracking is completed)	Check electrical connection and setting between indoor unit and outdoor unit
10	E203	Communication error between the outdoor unit and main micom (For PF #4 to #6 controllers, error will be determined from the time when the compressor is turned on.)	Check electrical connection and setting between indoor unit MAIN PBA - INVERTER PBA
11	E221	Error on outdoor temperature sensor (Short or Open)	Check Outdoor sensor Open / Short
12	E231	Error on outdoor COND OUT sensor (Short or Open)	Check Cond-Out sensor Open / Short
13	E251	Error on discharge temperature sensor of compressor 1 (Short or Open)	Check Discharge sensor Open / Short
14	E320	Error on OLP sensor (Short or Open)	Check OLP sensor Open / Short
15	E403	Compressor down due to freeze protection control	Check Outdoor Cond.
16	E404	System stop due to overload protection control	Check Comp. when it starts
17	E416	System stop due to discharge temperature	-
18	E422	Blockage detected on high pressure pipe	1. Check if the service valve is open 2. Check for refrigerant leakage (pipe connections, heat exchanger) and charge refrigerant if necessary 3. Check if there's any blockage on the refrigerant cycle (indoor unit/outdoor unit) 4. Check if additional refrigerant has been added after pipe extension
19	E425	Reverse phase or open phase	Check whether 3 phase is reversed or opened.
20	E440	Heating operation restricted at outdoor temperature over Theat_high value	HEATING
21	E441	Cooling operation restricted at outdoor temperature below Tcool_low value	COOLING
22	E458	Fan speed error	FAN1 ERROR

No.	Error Code	Meaning	Remarks
23	E461	Error due to operation failure of inverter compressor	-
24	E462	System stop due to full current control	-
25	E463	Over current trip / PFC over current error	Check OLP sensor
26	E464	IPM Over Current(O.C)	IPM
27	E465	Comp. Over load error	-
28	E466	DC-Link voltage under/over error	Check AC Power and DC Link Voltage
29	E467	Error due to abnormal rotation of the compressor or unconnected wire of compressor	Check Comp wire
30	E468	Error on current sensor (Short or Open)	Check Outdoor Inverter PBA.
31	E469	Error on DC-Link voltage sensor (Short or Open)	-
32	E470	Outdoor unit EEPROM Read/Write error (Option)	Check Outdoor EEPROM Data
33	E471	Outdoor unit EEPROM Read/Write error (H/W)	Check Outdoor EEPROM PBA
34	E472	AC Line Zero Cross Signal out	-
35	E473	Comp Lock error	-
36	E474	Error on IPM Heat Sink sensor of inverter 1 (Short or Open)	Check Outdoor Inverter PBA.
37	E475	Error on inverter fan 2	FAN2 ERROR
38	E484	PFC Overload (Over current) Error	Check Outdoor Inverter PBA.
39	E485	Error on input current sensor of inverter 1 (Short or Open)	Check Outdoor EEPROM PBA
40	E500	IPM over heat error on inverter 1	Check Outdoor Inverter PBA.
41	E508	Smart install is not installed	-
42	E554	Gas leak detected	Check the refrigerant
43	E556	Error due to mismatching capacity of indoor and outdoor unit	Check the indoor and outdoor unit capacity
45	E590	Inverter EEPROM Checksum error	-
46	E660	Inverter Boot Code error	-

4-4 Troubleshooting by symptoms

4-4-1 Indoor temperature sensor (open/short)

Wire remote controller display	E121
Symptom	Error of Room sensor in the indoor unit(Open/Short)
Failure	Short or leakage of the Room sensor

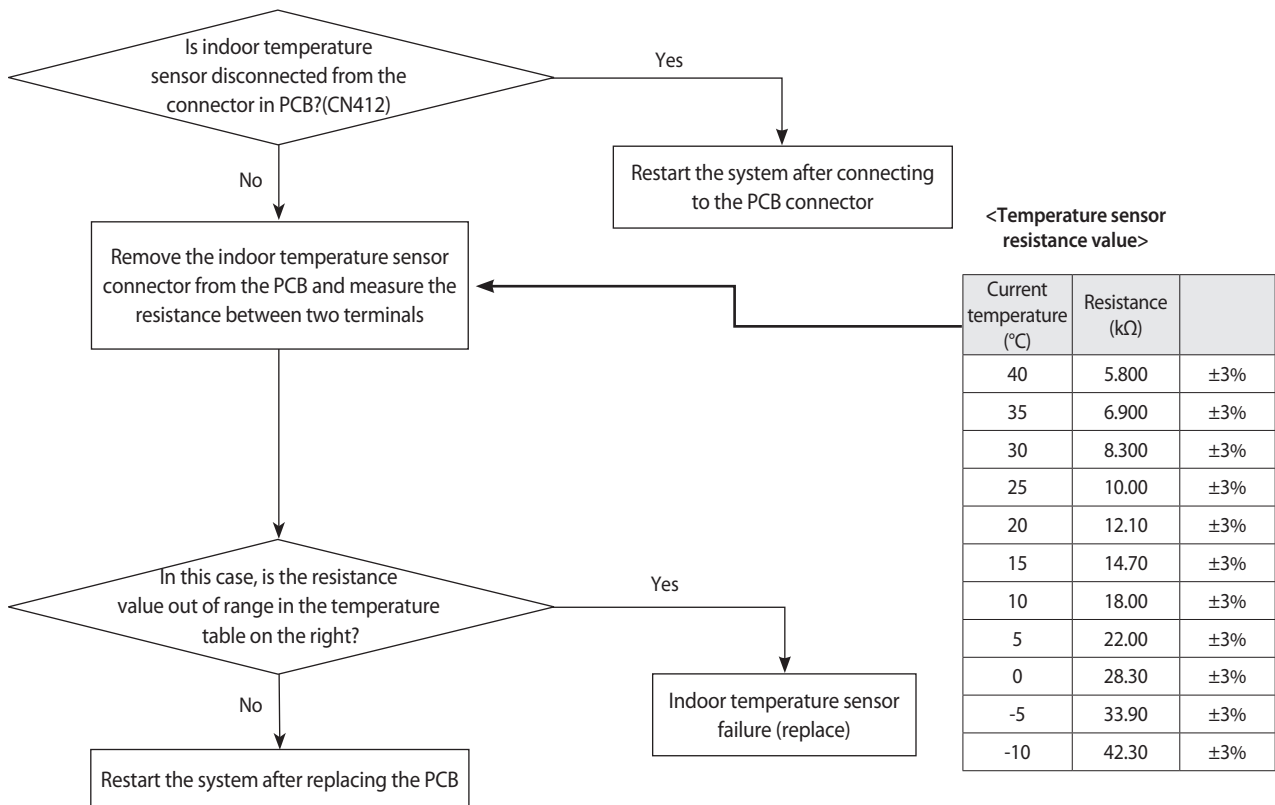

4-4-2 Eva in and out sensor (open/short)

Wire remote controller display	E122, E123
Symptom	Error of EVA-IN, EVA-OUT sensor in the indoor unit (Open/Short)
Failure	Short or leakage of the EVA sensor

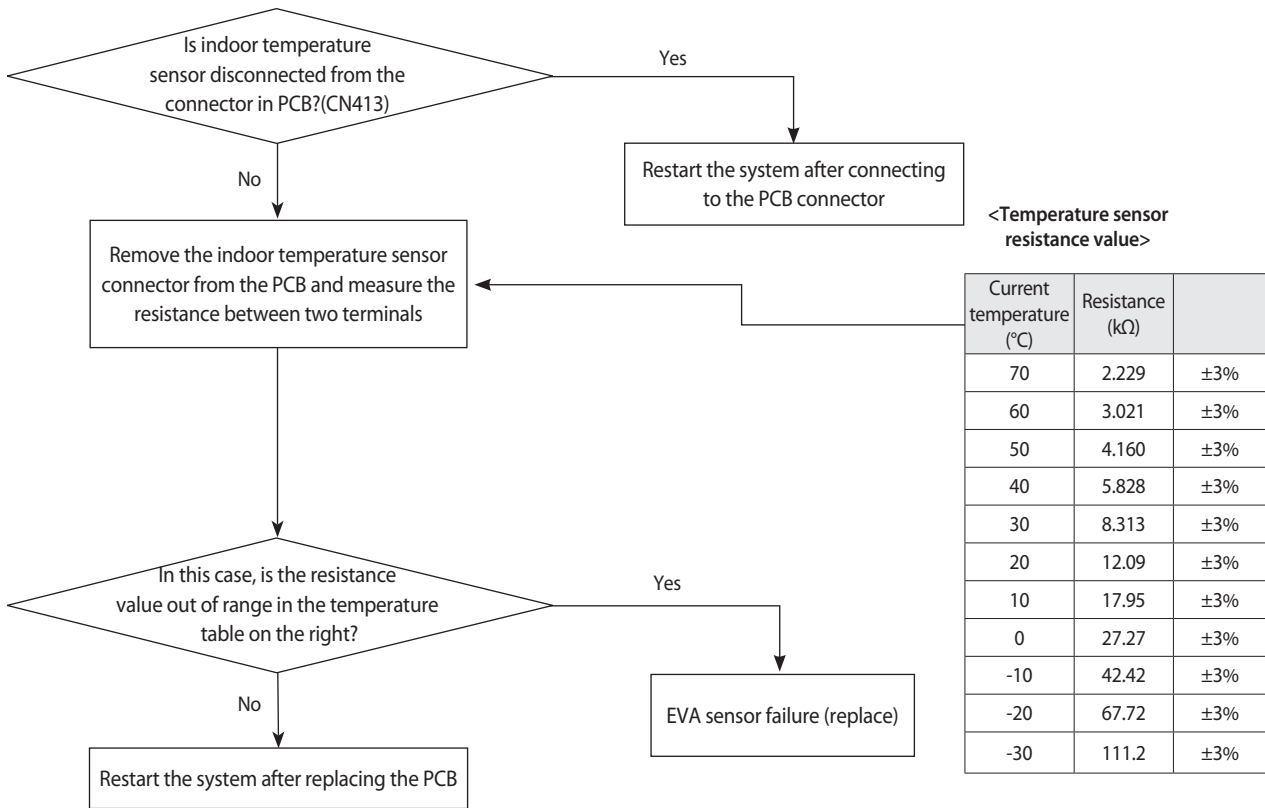

4-4-3 Float switch(Open)

Wire remote controller display	E153
Symptom	2nd Detection of the float switch
Failure	Float switch open

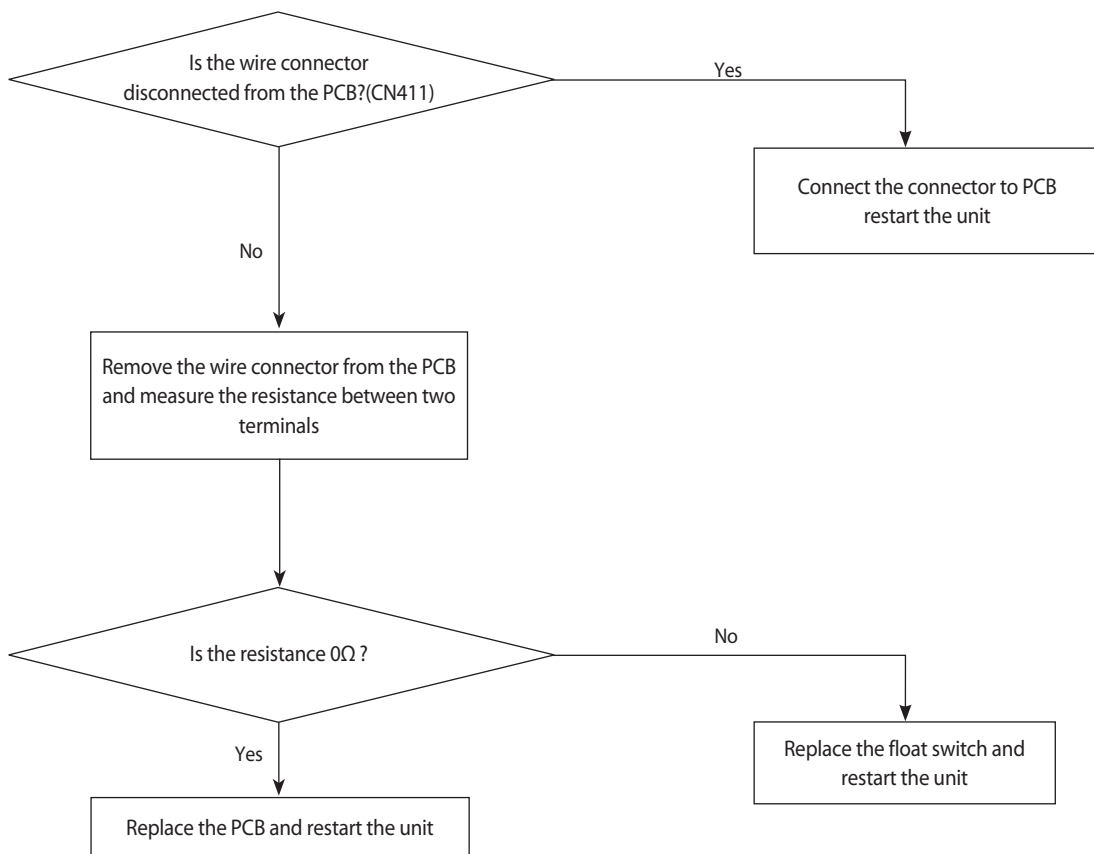

4-4-4 Fan error

Wire remote controller display	E154
Symptom	Error of Fan motor in the indoor unit
Failure	Fan error

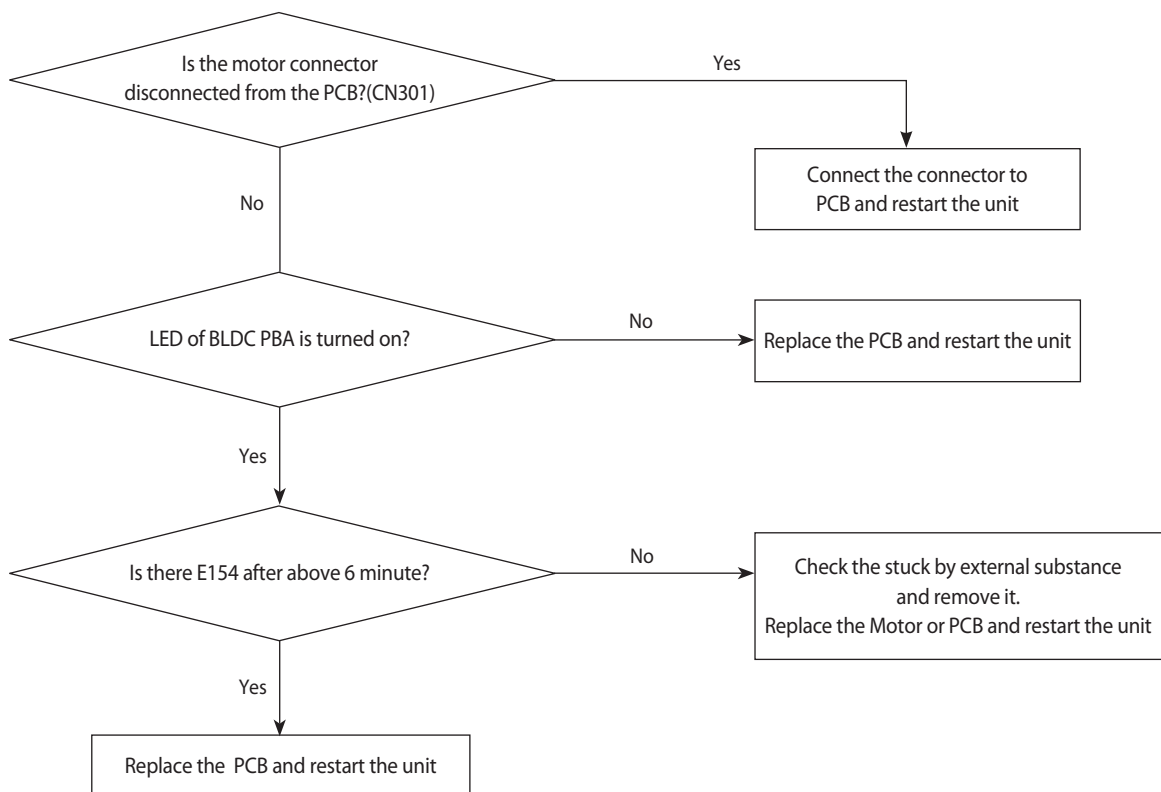

4-4-5 EEPROM error

Wire remote controller display	E162
Symptom	EEPROM PCB disconnected from the MAIN PCB
Failure	Option error

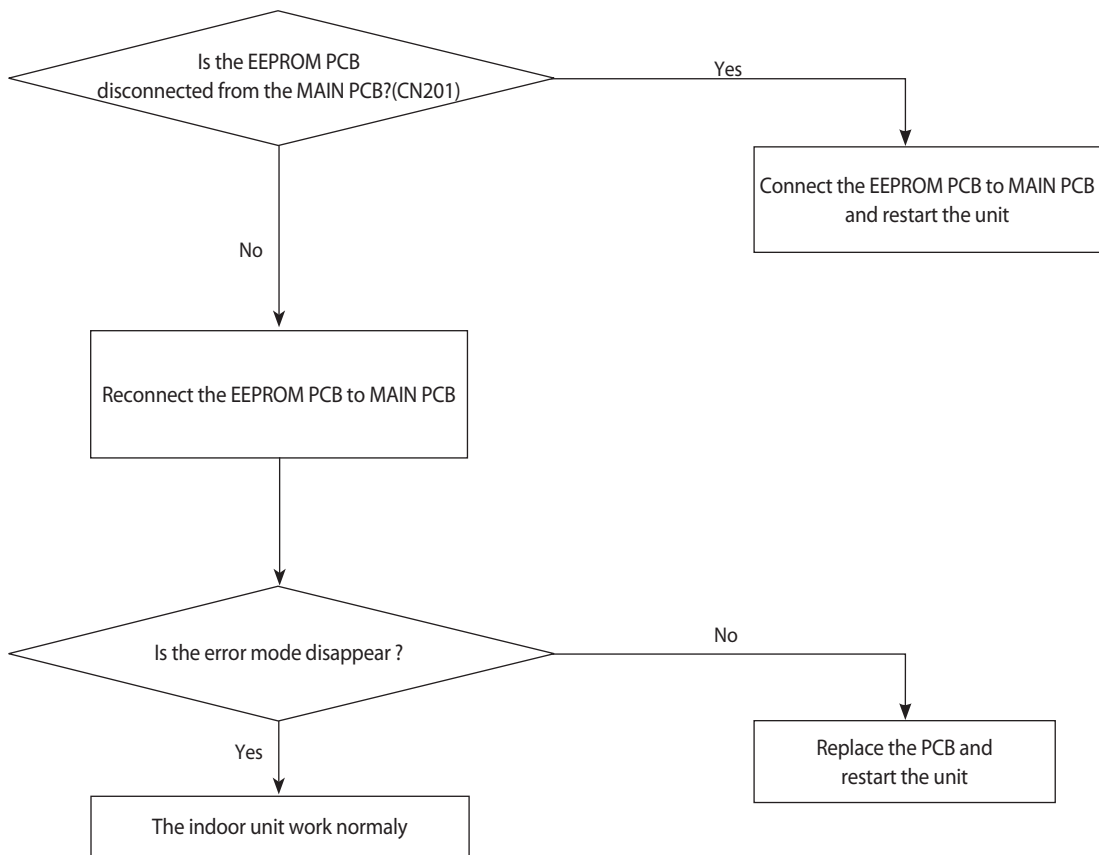

4-4-6 Option error

Wire remote controller display	E163
Symptom	EEPROM option setting error
Failure	Option error

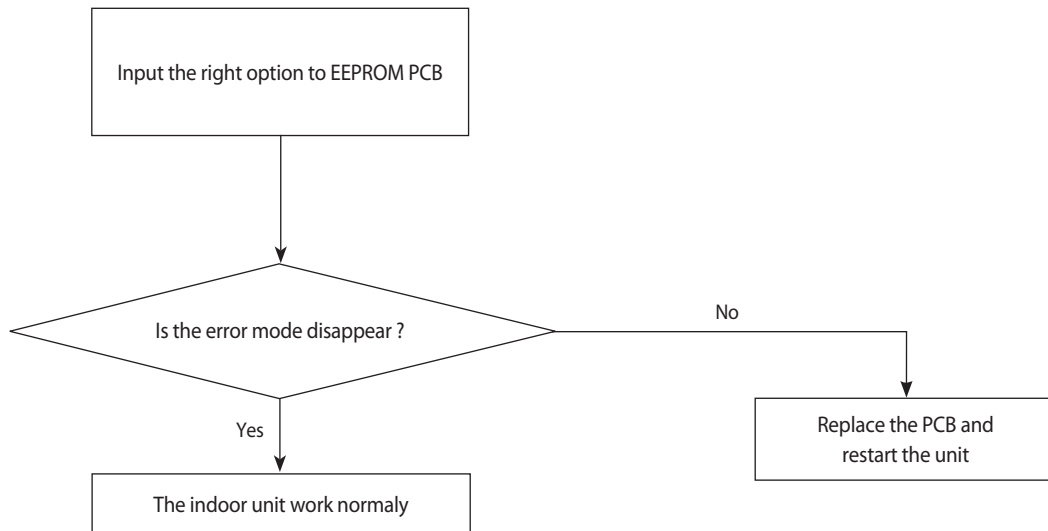

4-4-7 Terminal Block's Terminal Fuse(Open)

Wire remote controller display	E198
Symptom	Error of Terminal Block's Terminal Fuse(Open)
Failure	Fuse open

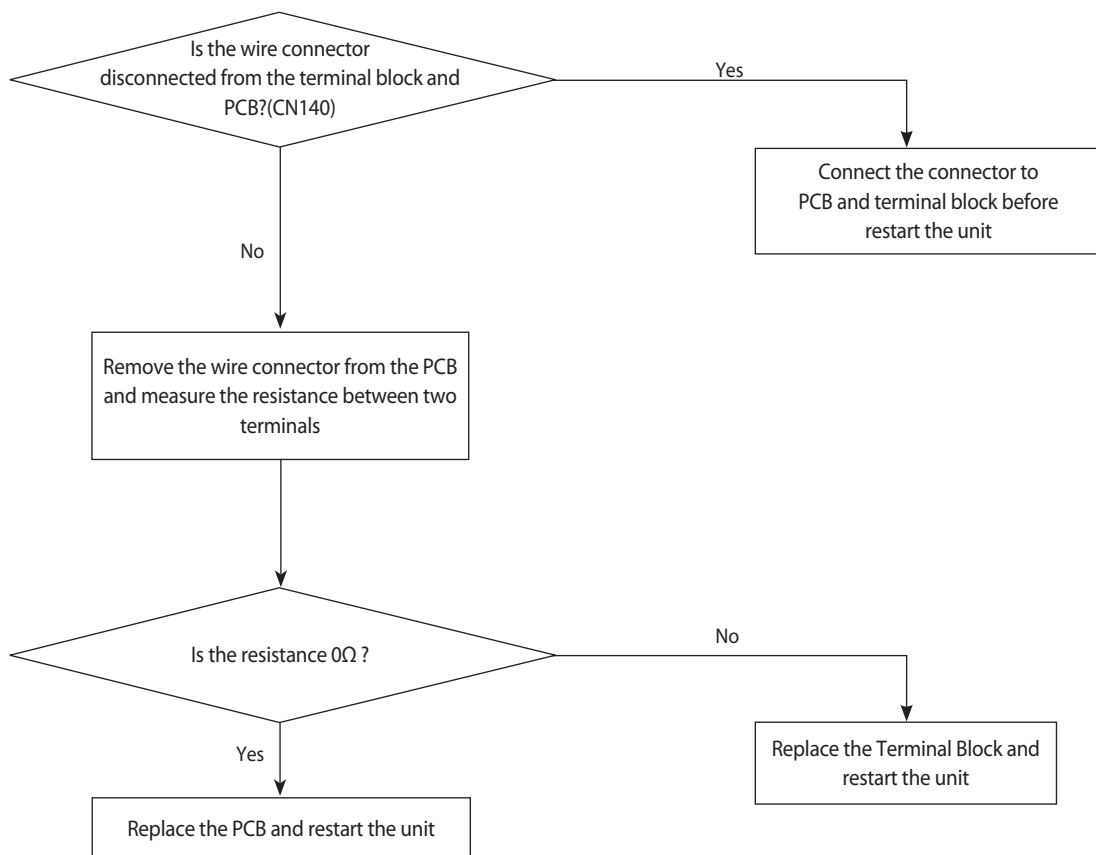

4-4-8 Communication error after finishing tracking (E202)

1. Check items
 - 1) Is the communication cable short/open?
 - 2) Is there a response from the indoor unit PCB?

2. Check procedure

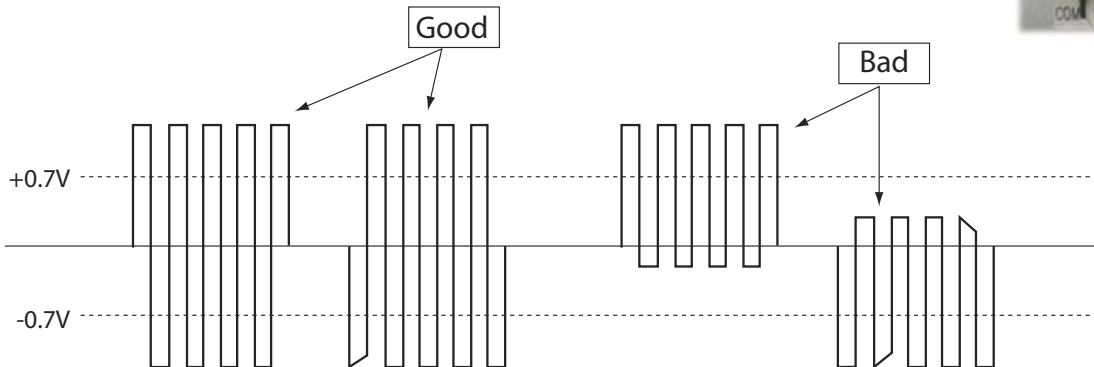
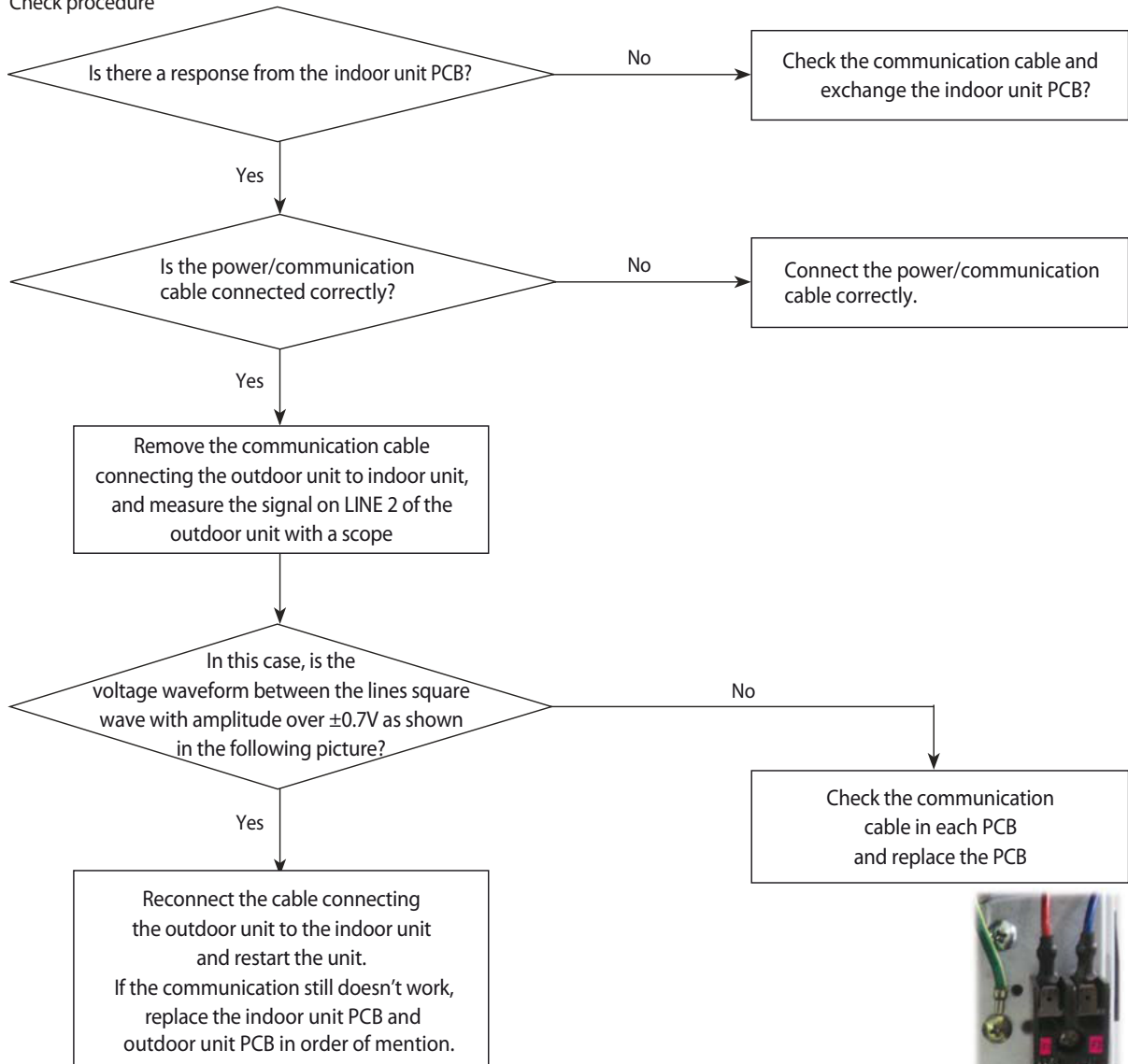

cf.) If there is no oscillo scope, it can be replaced multimeter instead of osillo scope.
 If measured voltage is floating value from 0.1V to 4.5V, then it means that the PCB is normal.

4-4-9 Outdoor's service valve(Clog)

Wire remote controller display	E422
Symptom	Clogging of outdoor's service valve
Failure	Valve clog

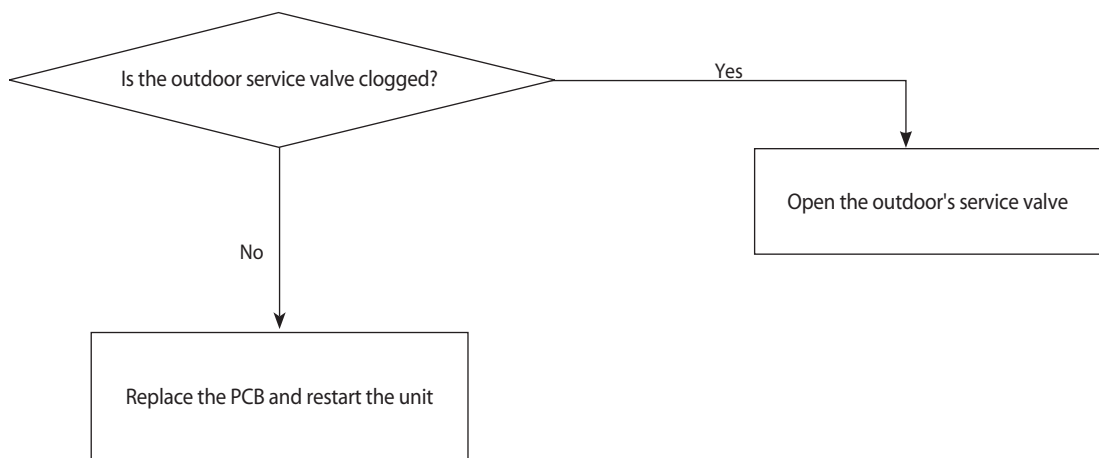

4-4-10 No Power(completely dead) - Initial diagnosis

Outdoor unit is not powered on – Initial diagnosis (1phase)

1. Check items
 - 1) Is the power supply voltage 220V?
 - 2) Is the AC power connected correctly?
 - 3) Are the LEDs in the main PCB and inverter PCB of the outdoor unit ON?
 - 4) Is the input power voltage of the indoor unit 220V?
 - 5) Is the wired remote controller connected correctly?
2. Check procedure

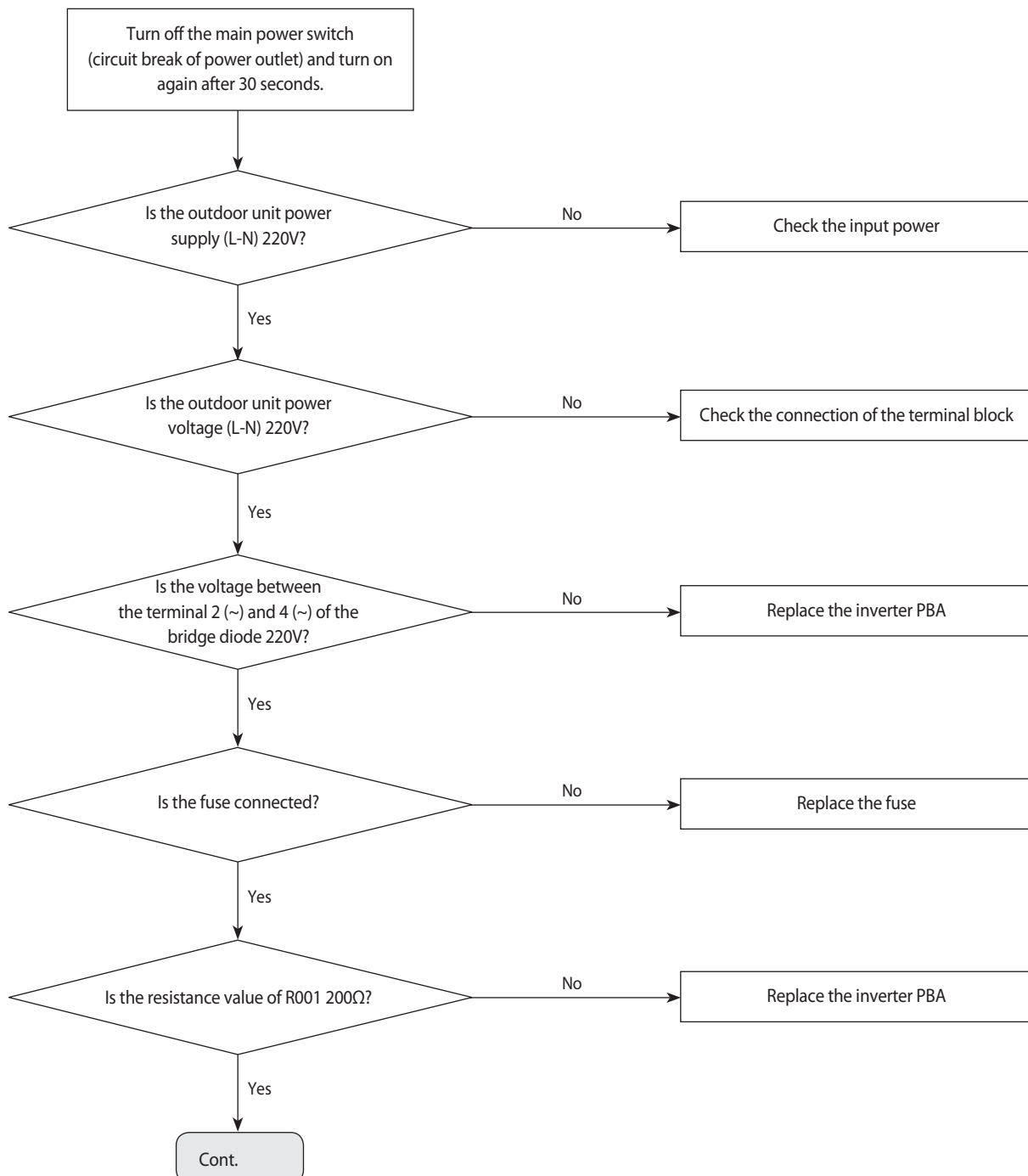

Outdoor unit is not powered on – Initial diagnosis (1phase) (cont.)

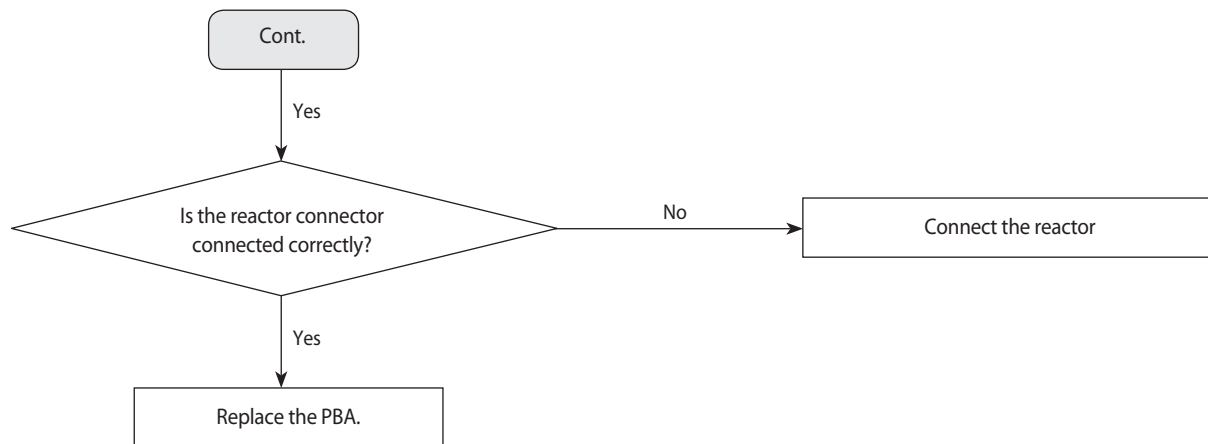

Outdoor unit is not powered on – Initial diagnosis (3phase)

1. Check items:
 - 1) Is the power supply voltage 380V?
 - 2) Is the AC power connected correctly?
 - 3) Are the LEDs in the main PCB and inverter PCB of the outdoor unit ON?
 - 4) Is the input power voltage of the indoor unit 220V?
 - 5) Is the wired remote controller connected correctly?

2. Troubleshooting procedure

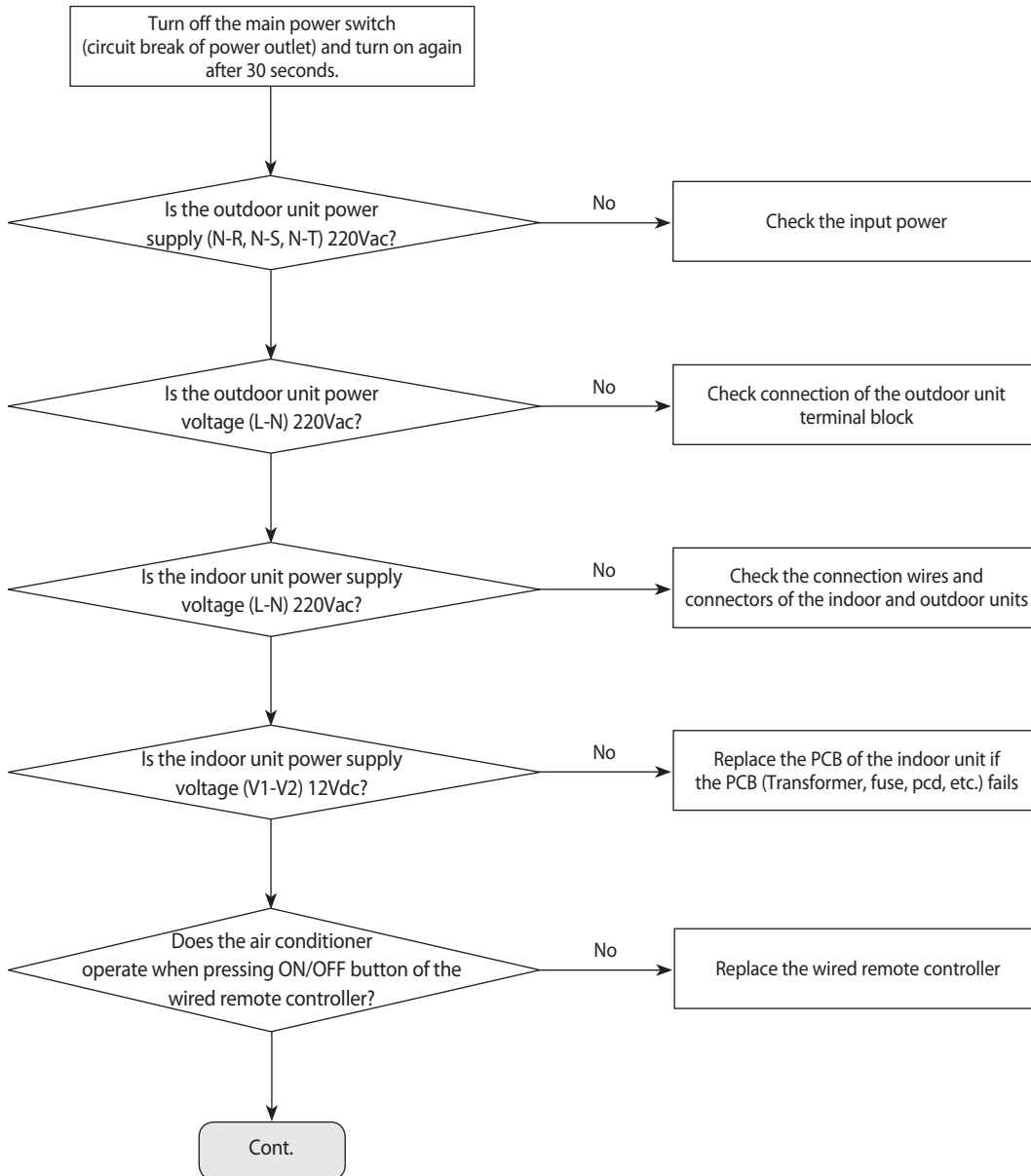

Outdoor unit is not powered on – Initial diagnosis (3phase) (cont.)

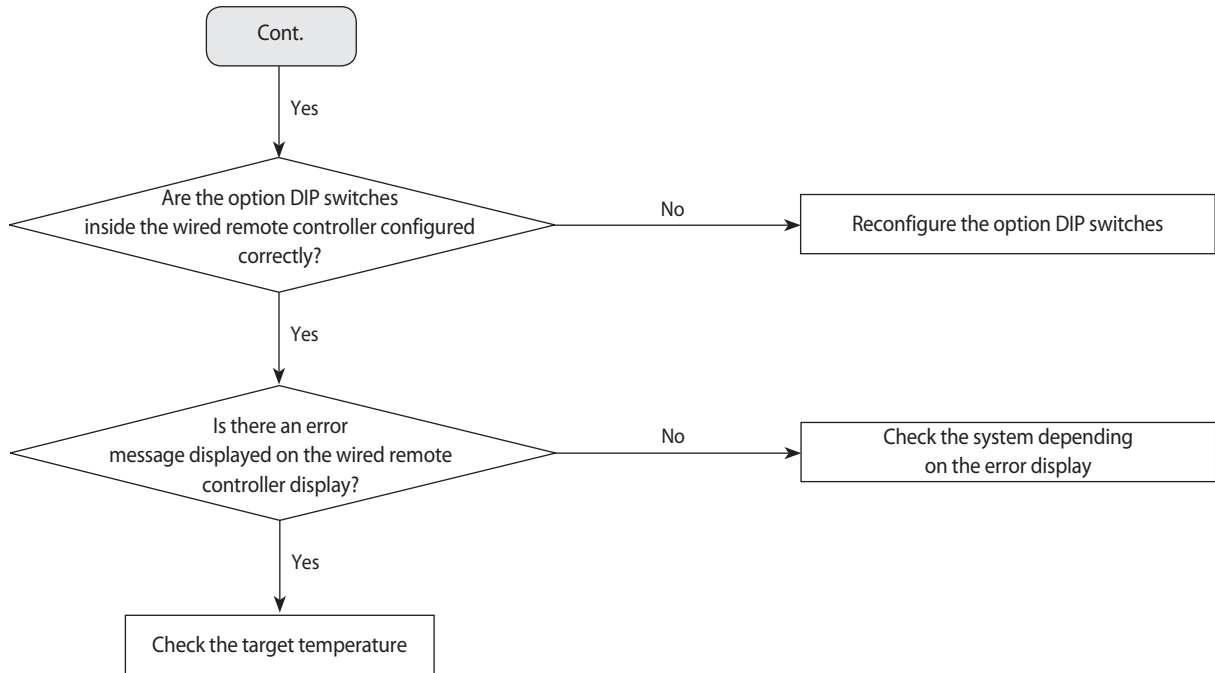

4-4-11 E102 : Communication error between indoor and outdoor unit
E201 : Unit quantity miss matching between Indoor and Outdoor
E202 : Abnormal state, no communication between Indoor and Outdoor Main PCB
E203 : 1min Time out of communication error(Main ↔ Inverter)

1. Checklist :

- 1) Is the communication cable between the indoor unit and outdoor unit connected correctly?
- 2) Isn't the power cable and communication cable wiring error?

2. Troubleshooting procedure

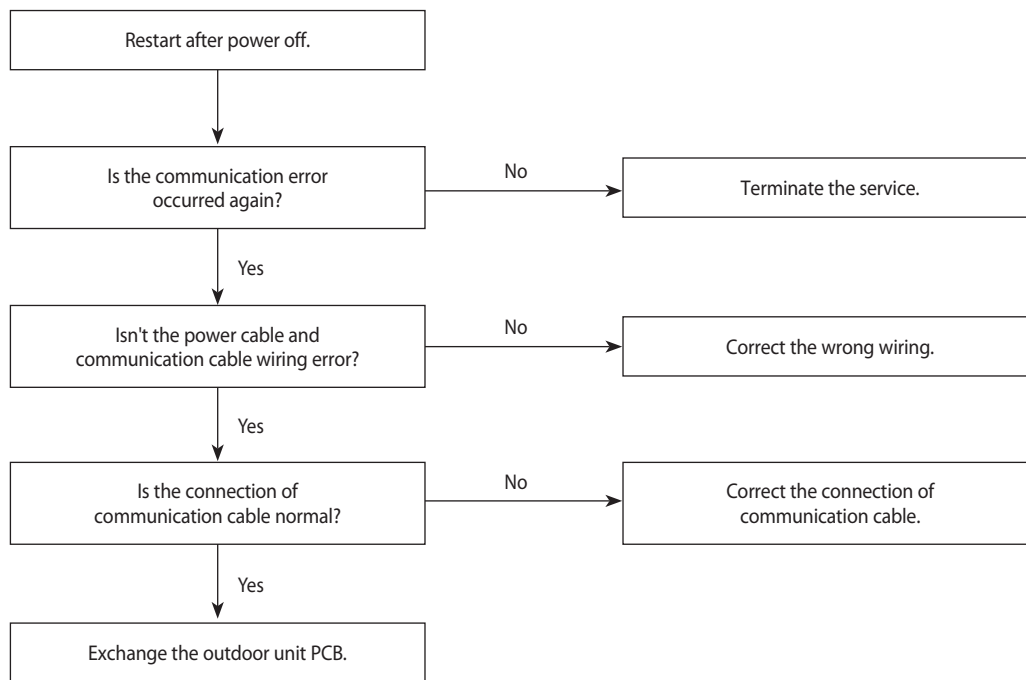

4-4-12 External Sensor Error (Error Code: E221, E231, E251, E320)

1. Test Item

- 1) Check the connection of the temperature sensor connector.
- 2) Check the resistance value of the temperature sensor.

Error Code	Description
E221	Error of the temperature sensor of the outdoor unit
E231	Error of the COND. sensor of the outdoor unit
E251	Error of the discharge sensor of the outdoor unit
E320	Error of the OLP sensor of the outdoor unit

2. Check procedure

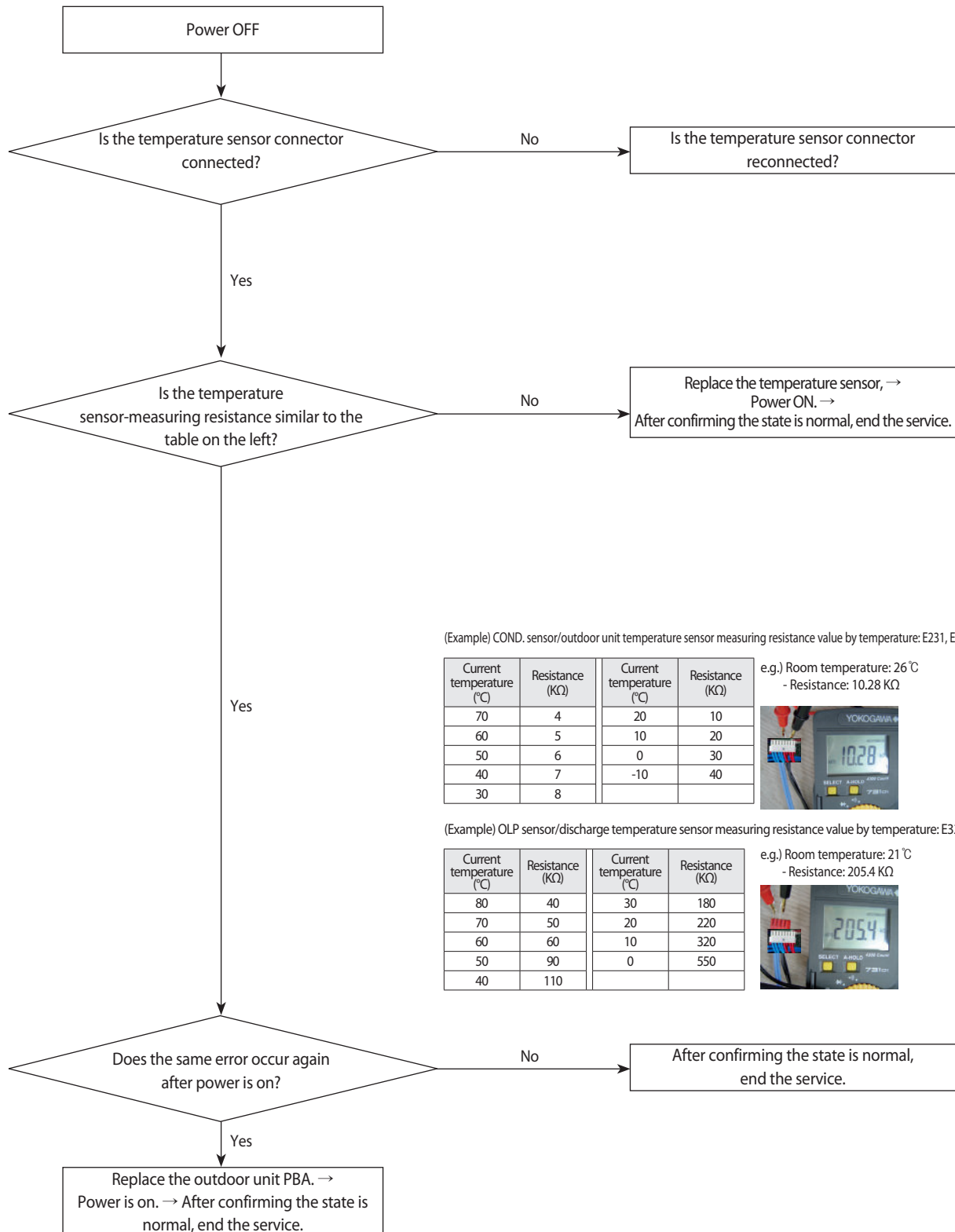

(Example) COND. sensor/outdoor unit temperature sensor measuring resistance value by temperature: E231, E221

Current temperature (°C)	Resistance (KΩ)	Current temperature (°C)	Resistance (KΩ)
70	4	20	10
60	5	10	20
50	6	0	30
40	7	-10	40
30	8		

e.g.) Room temperature: 26 °C
- Resistance: 10.28 KΩ



(Example) OLP sensor/discharge temperature sensor measuring resistance value by temperature: E320, E251.

Current temperature (°C)	Resistance (KΩ)	Current temperature (°C)	Resistance (KΩ)
80	40	30	180
70	50	20	220
60	60	10	320
50	90	0	550
40	110		

e.g.) Room temperature: 21 °C
- Resistance: 205.4 KΩ



4-4-13 E403 : Freezing control causes comp. down

Outdoor unit display	E403
Criteria	•All the operating indoor machines do not reach -4°C for more than five minutes
Cause of problem	•Check if the indoor FAN/MOTOR operates normally. •Check if the indoor EEV operates normally. •Check the indoor heat exchanger's IN/OUT sensor. •Check for clogging in the suction area of the indoor machine.

1. How to check

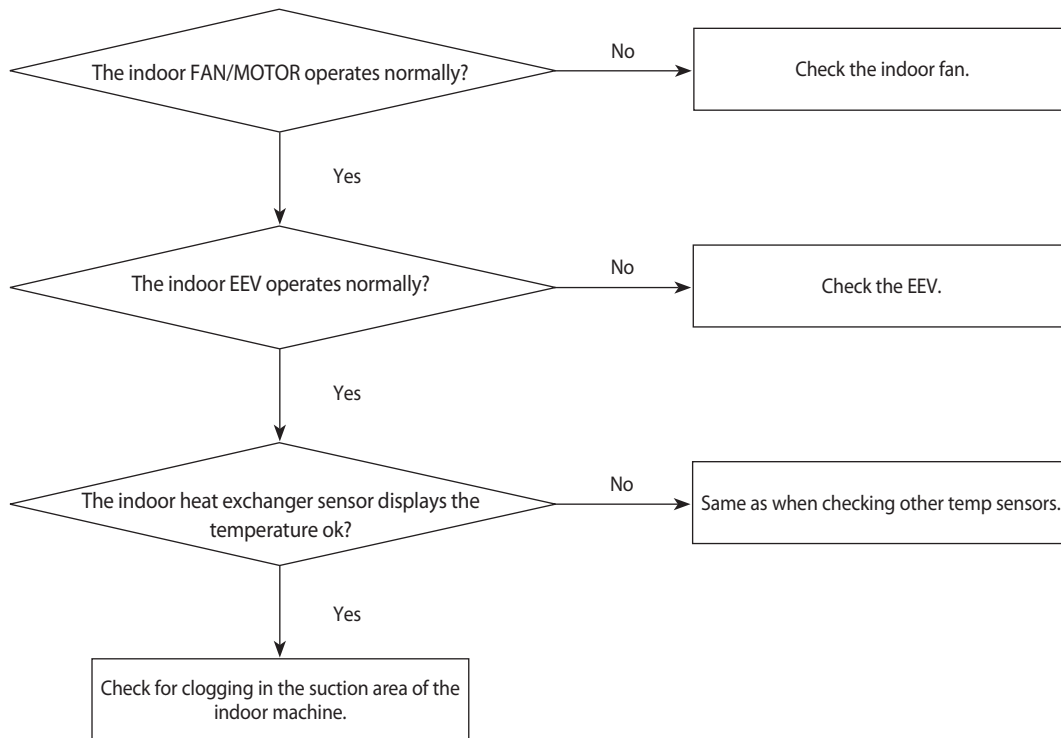

4-4-14 E416 : Discharge temperature sensor error

Outdoor unit display	E416
Criteria	•The compressor temperature above 110°C.
Cause of problem	<ul style="list-style-type: none"> •Insufficient coolant. •Clogging in the outdoor machine's solenoid valve. •Clogging in the sub valve. •Malfunctioning exhaust gas temp sensor. •Clogging in the pipeline and the filter. •Liquid EEV damaged.

1. How to check

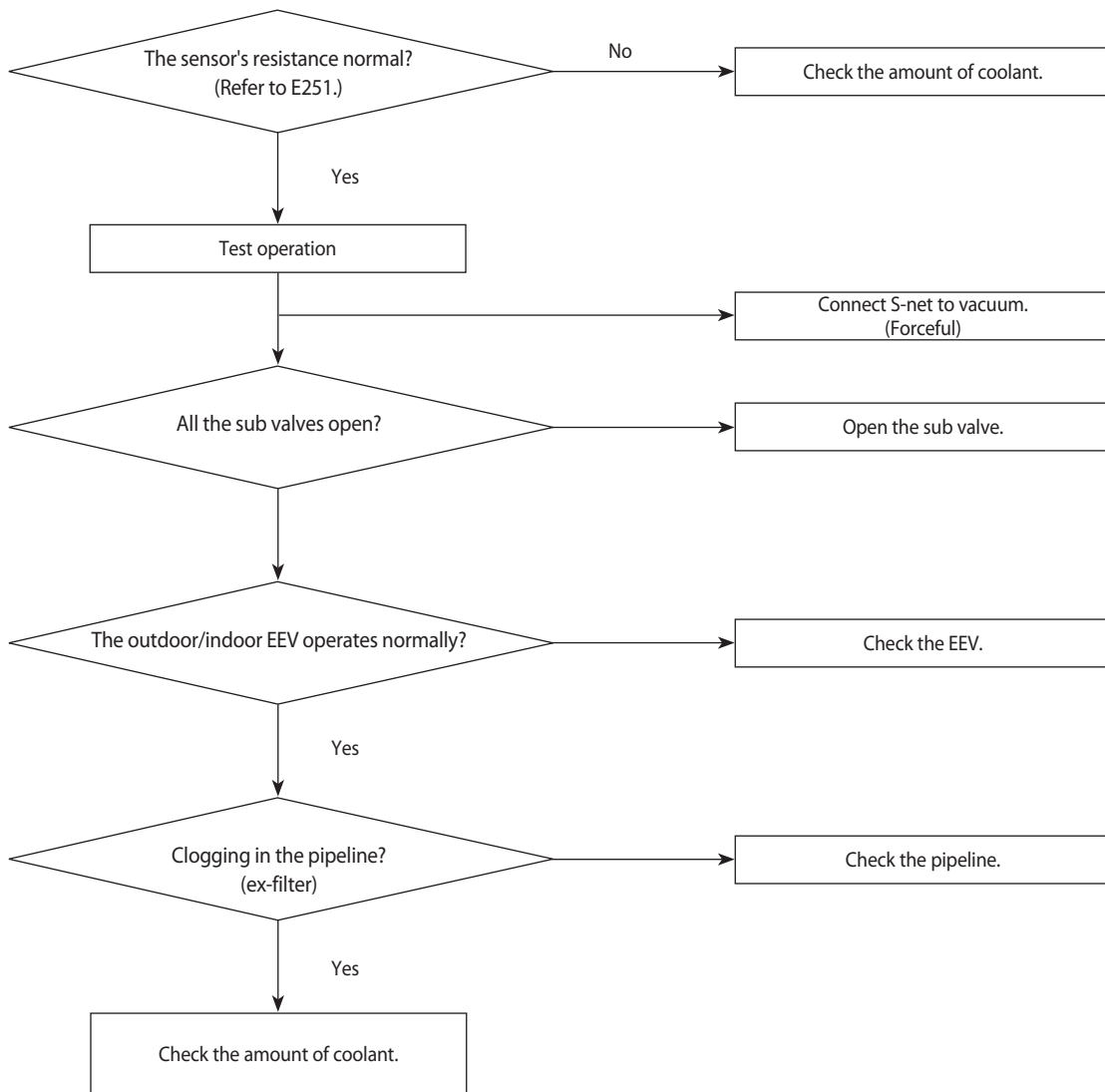

4-4-15 E440, E441 : Abnormal outside temperature halts operation of the compressor

Outdoor unit display	E440 (No heater operation with the outside temperature above 30°C.) E441 No AC operation with the outside temperature below -10°C.)
Criteria	•The compressor temperature above 110°C.
Cause of problem	E440: If the outside temperature is above 30°C, operation of the indoor heater with a remote control causes this error. E441: The indoor machine remote control ON signal. If the outside temperature is below -10°C before the AC runs, this error occurs.
Cause of problem	•OLP SENSOR temp above Trip_Dis.

1. How to check

The above malfunction codes do not indicate a malfunction of the product. All you have to do is change the temperature suitably for the limits shown in the manual. When the product malfunctions, if the actual situation does not match the above diagnosis, measure the temperature of incoming air with S-net to see if the measurement is the same as the actual outdoor temperature. If not, replace the temperature sensor.

4-4-16 Outdoor unit BLDC Fan1 or Fan2 error (E458 : Fan1 error, E475 : Fan2 error)

1. Checklist :

- 1) Isn't the fan locked?
- 2) Is the sensor placed correctly?
- 3) Does the both terminal of sensor satisfy the resistance value in accordance with temperature?
- 4) Is the resistance value of sensor connection pull_up correct?

2. Troubleshooting procedure

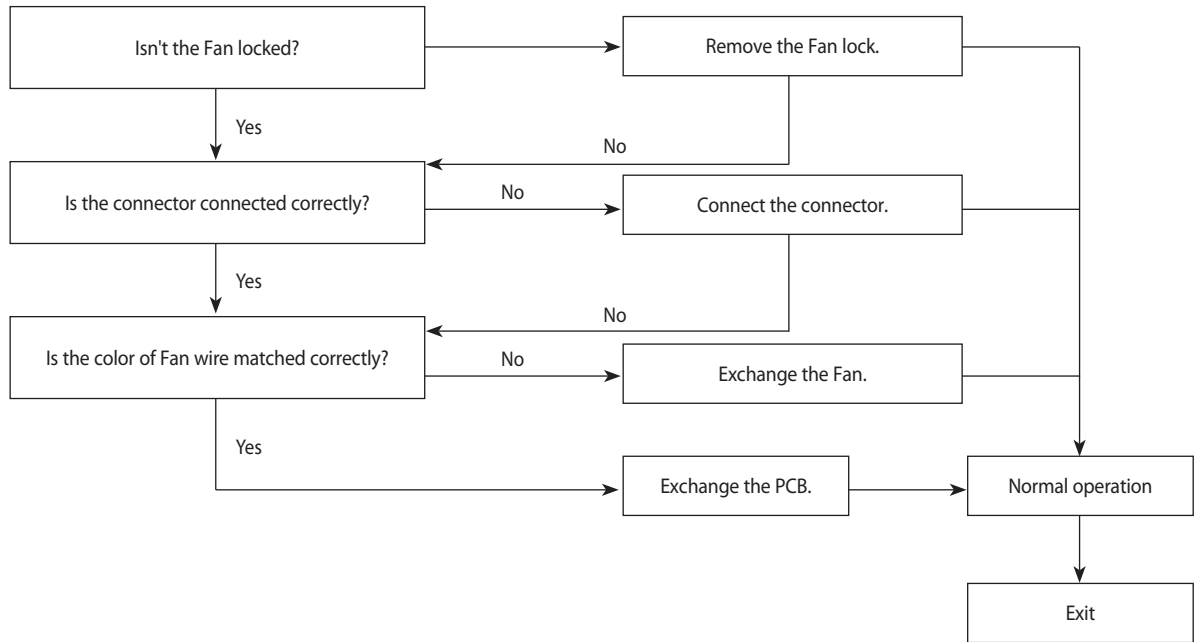

4-4-17 E461: Compressor start error E467: Compressor wire missing error

1. Checklist :
 - 1) Is the connection of cable for the compressor and power?
 - 2) Is the interphase resistance of compressor normal?
2. Troubleshooting procedure

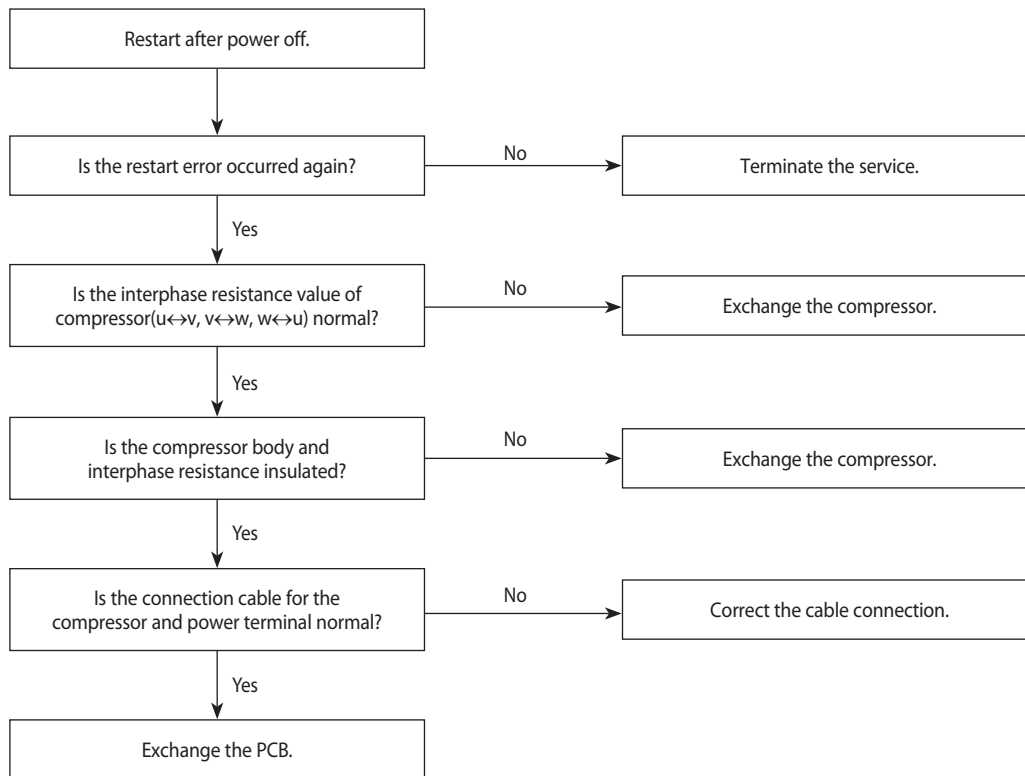

**4-4-18 E462 : Current protection control causes comp. down
E484 : PFC overload error**

Outdoor unit display	E462,E484
Criteria	• The outdoor machine input current above I_Trip.
Cause of problem	•Check the compressor input voltage. (error for low voltage.) •Check the overcurrent option setting.

1. How to check

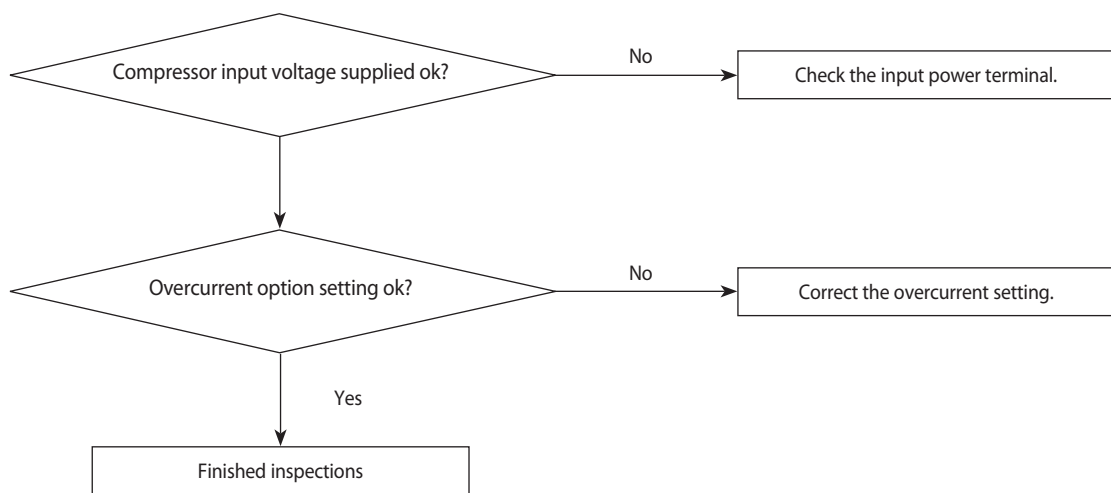

4-4-19 E463 : OLP protection control caused comp. down

Outdoor unit display	E463
Criteria	• OLP SENSOR temp above Trip_Dis.
Cause of problem	• See if the sub valve is open. • Check the amount of coolant. • Check the OLP sensor.

1. How to check

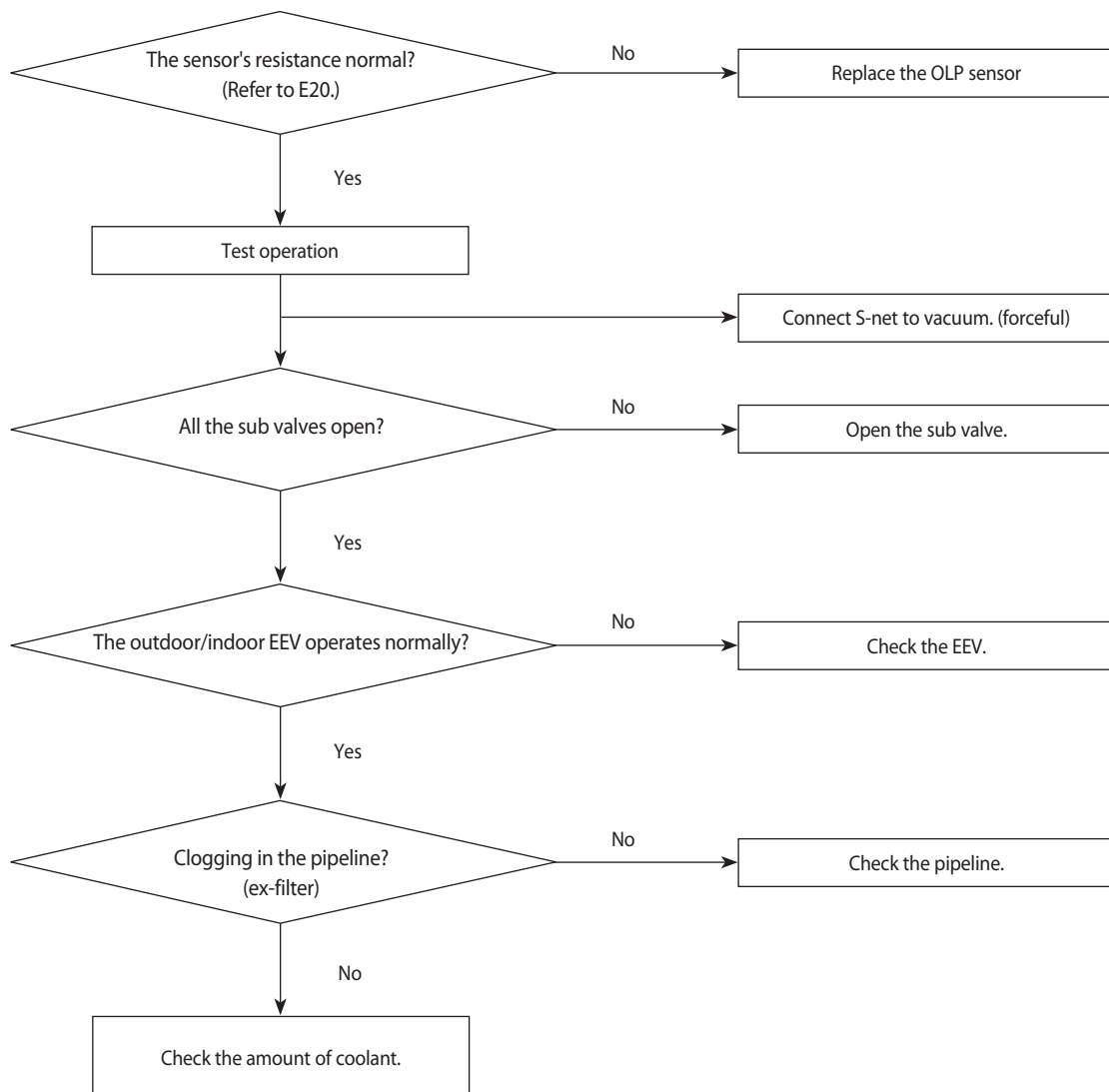

4-4-20 E464 : O.C. (Over Current) error

1. Checklist :

- 1) Is the refrigerant charged properly?
- 2) Does the compressor rotate normally?(Reverse rotation, Locking etc.)
- 3) Is connection of compressor wire normal?
- 4) Is compressor motor normal?(Insulation, Coil resistance etc.)
- 5) Does a temporary cycle overload condition happened?

2. Troubleshooting procedure

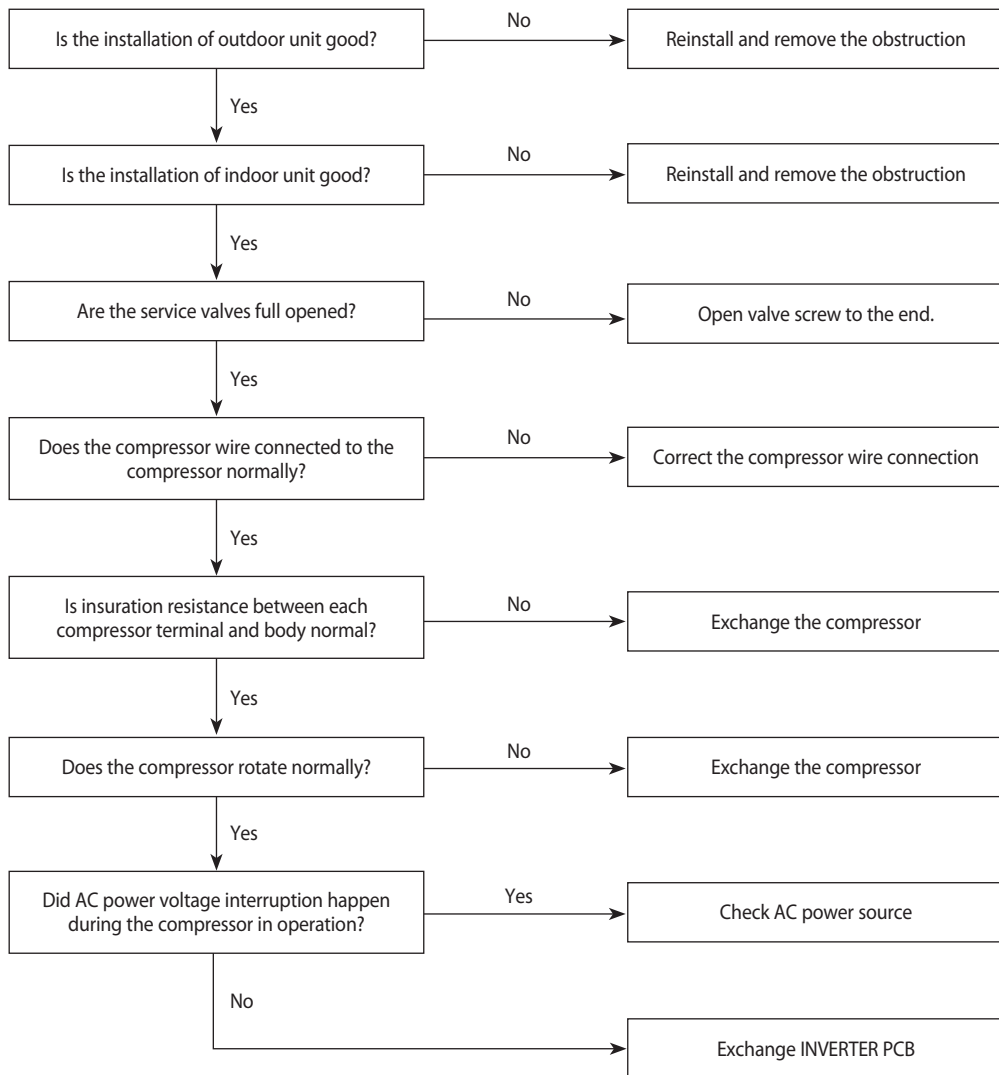

4-4-21 E466: DC Link Over voltage/ Low voltage error

1. Checklist :

- 1) Is the power voltage normal?(Lightning, Power interruption etc.)
- 2) Is AC Power cable connection normal?(Detaching the wire)

2. Troubleshooting procedure

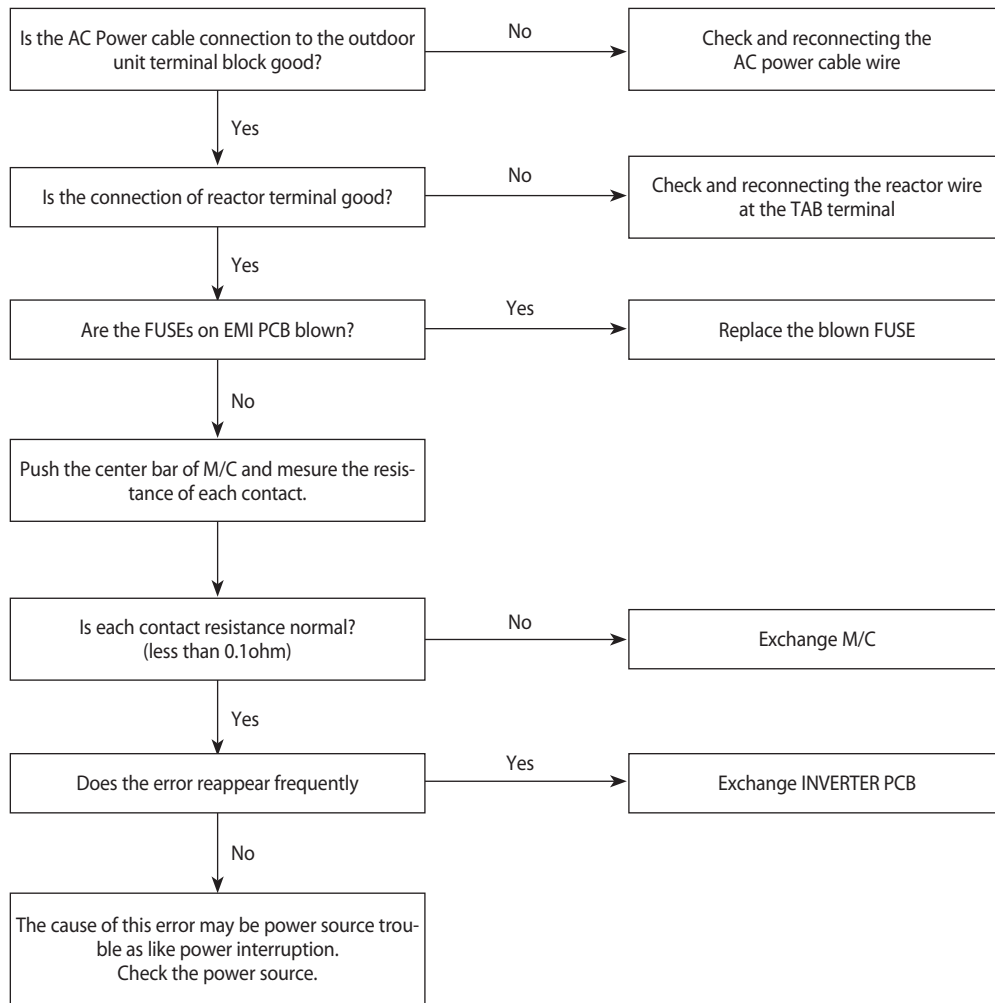

4-4-22 Pipe Blocking Error (Error Code: E422)

1. Test Item

- 1) Check the open state of the outdoor unit service valve.
- 2) Check the connection of the pipe.
- 3) Check the operation of the EEV.
- 4) Check the refrigerant leakage.
- 5) Check the connection of the indoor unit PBA EVA sensor.
- 6) Check the fault in the indoor unit EVA sensor.

2. Check procedure

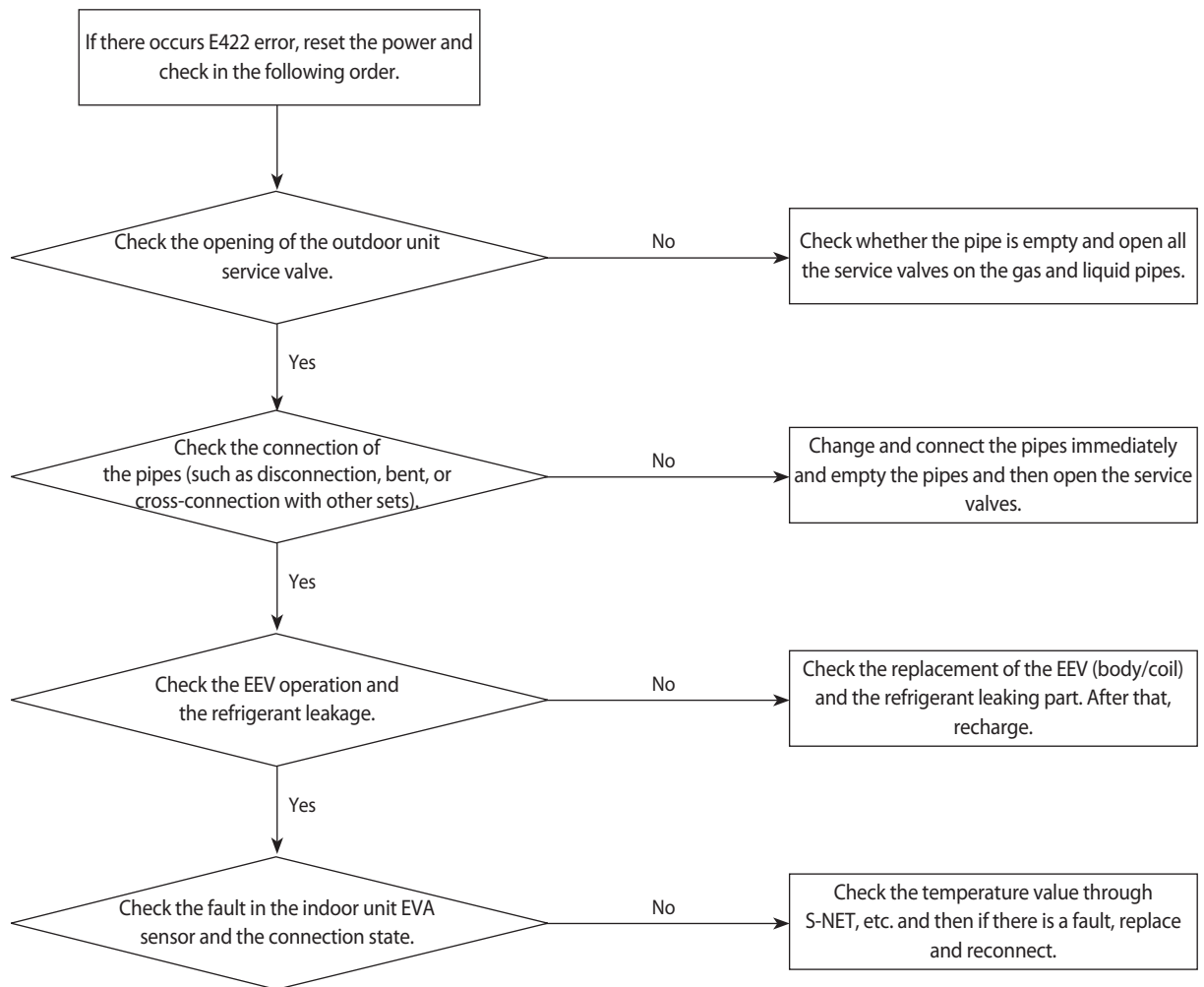

4-4-23 The others

1. E465 : Compressor over load error

- If a compressor works improperly, change the compressor and check if it works properly.
- If a compressor is normal, check the assembly between Heatsink-Inverter PBA. If it is fine, change Inverter PBA.

2. E468 : Current sensor error

- Check EEPROM data.
- Check PCB operates properly.

3. E471 : Outdoor EEPROM error

- Upload EEPROM on Outdoor unit Main PBA.

4. E474 : IPM(IGBT Module) or PFCM Temperature sensor Error

- E500 : IPM is over heated
- Check IPM is well assembled to heatsink
- Check whether inlet port is clogged.
- Change IPM if it is defective one

5. E554 : Gas leak error

- Check refrigerant charge
- Check Indoor EVA sensor
- Check Service valve is open.
- Check the pipes and wires correctly connected.

6. E556 : Capacity miss match between indoor and outdoor

- Check the model name of indoor and outdoor unit and set option code on indoor unit again.

7. Outdoor overload protection control (at the stop of the compressor.): E404

- Check whether the fan and the motor operate normally.
- Check the operation of EEV.
- Check the temperature sensor of the indoor unit heat exchanger.
- Check the indoor unit inlet blocking.

5. PCB Diagram and Parts List

5-1 Indoor Unit

MAIN PCB

■ AC052MNC DKH / AC071MNC DKH

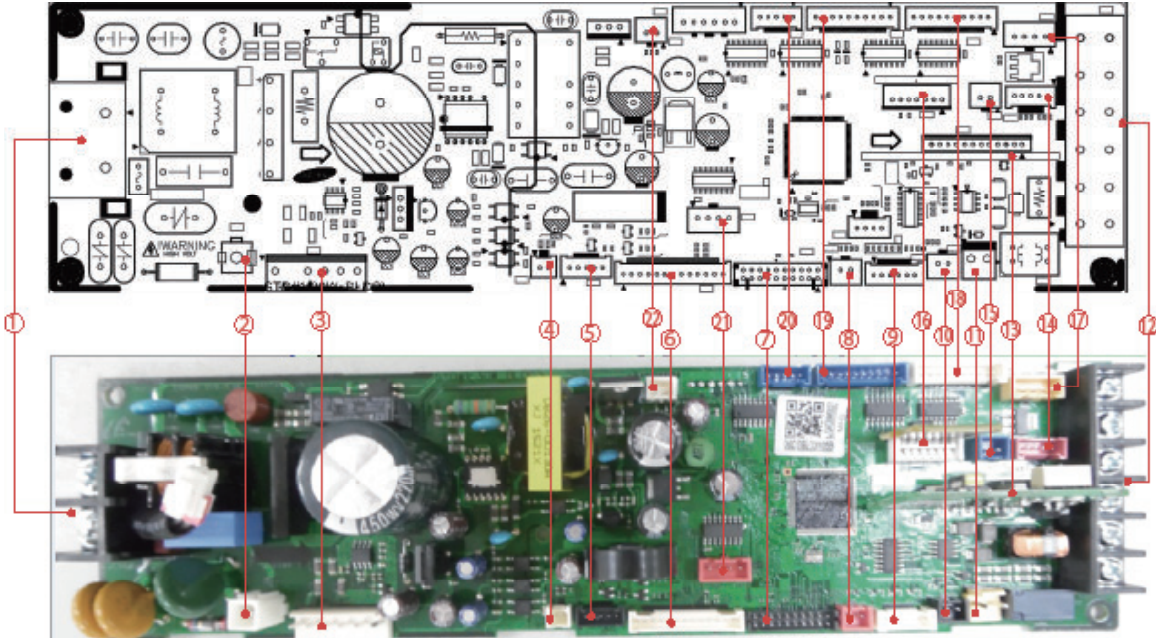

1	TB101	INPUT POWER	
2	CN101	GVD	YDW236-01(WHT)
3	CN701	BLDC FAN MOTOR	YW396-06V(WHT)
4	CN140	FUSE CHECK	SMW200-02(WHT)
5	CN809	AUTO GRILLE	SMW200-05(BLK)
6	CN501	DISPLAY	SMY200-13(WHT)
7	CN301	DOWNLOAD	YDW200-20(BLK)
8	CN83	EXTERNAL SIGNAL	SMW250-02(RED)
9	CN413	EVEA IN/OUT/DIS	SMW200-06(NTR)
10	CN411	FL-SW	SME250-02(BLK)
11	CN103	DRAIN PUMP	YW396-02V(YEL)
12	TE04	COM1 12V COM2	DAPC-2009-6P
13	CN311	2WIRE OPTION	BMW200-12(wht)
14	CN401	HUMAN SENSOR	SMW200-05(RED)
15	CN804	VENTILATOR	SMW250-02(BLU)
16	CN201	EEPROM PBA CONNECTOR	B7P-MQ(WHT)
17	CN801	SPI MODULE	SMW250-04(YEL)
18	CN805	LOUVER 1/2	SMW200-10(NTR)
19	CN806	LOUVER 3/4	SMW200-10P(BLU)
20	CN807	LOUVER 5	SMW200-05(BLU)
21	CN81	EXT_CTRL	SMW250-04(RED)
22	CN412	ROOM SENSOR	SMW250-02(WHT)

MAIN PCB

■ AC100MNC DKH / AC120MNC DKH / AC140MNC DKH

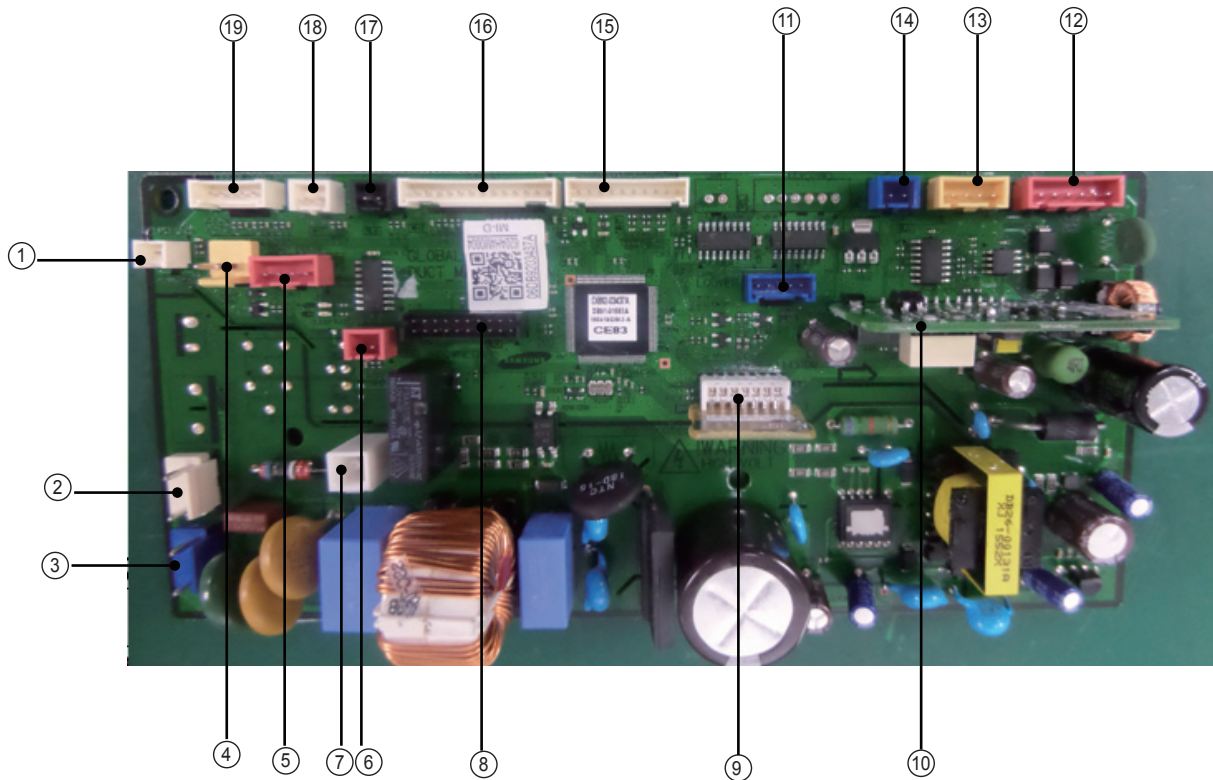

No	Part Code	Local	Function	Description
1	3711-003942	CN140	SMW200-02(WHT)	FUSE BLOCK
2	3711-000203	CN906	YM396-03AV(WHT)	BLDC PBA POWER
3	3711-003404	CN101	YW396-03AV(BLU)	POWER INPUT
4	3711-000179	CN701	YW396-02V(YEL)	DRAIN PUMP
5	3711-000939	CN81	SMW250-04(RED)	ERROR CHECK/COMP CHECK
6	3711-000796	CN83	SMW250-02(RED)	ON/OFF EXTERNAL SIGNAL
7	3711-000744	CN1	TDW236-01(WHT)	GND
8	3711-002001	CN301	YDW200-20(BLK)	DOWNLOAD
9	3711-007817	CN201	B7P-MQ(WHT)	EEPROM PBA
10	3711-004773	CN311	BMW200-12(WHT)	2WIRE OPTION
11	3711-005097	CN601	SMW200-05(BLU)	LOUVER
12	3711-001037	CN302	SMW250-06(RED)	COM1 12V COM2
13	3711-000941	CN801	SMW250-04(YEL)	SPI MODULE

No	Part Code	Local	Function	Description
14	3711-000795	CN804	SMW250-02(BLU)	VENTILATOR
15	3711-004182	CN905	SMW200-10(WHT)	FAN MOTOR COMM
16	3711-003895	CN501	SMW200-13(WHT)	DISPLAY
17	3711-000794	CN411	SMW250-02(BLK)	FLOAT-S/W
18	3711-000015	CN412	SMW250-02(WHT)	ROOM-TEMP
19	3711-004236	CN413	SMW200-06(NTR)	EVA DIS/OUT SENSOR

5-2 Outdoor Unit

5-2-1 MAIN PBA

■ AC052MXADKH / AC071MXADKH

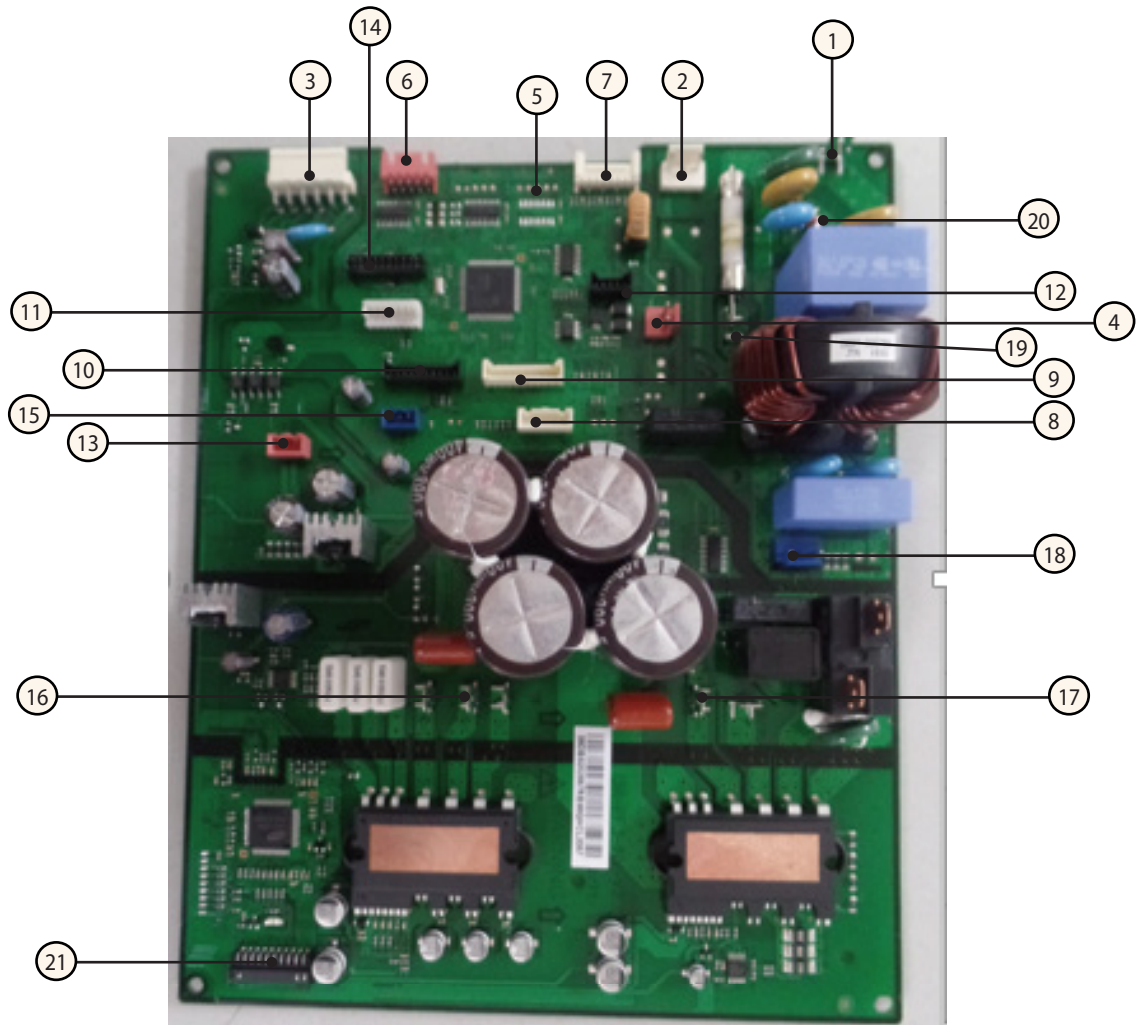

No.	Function	No.	Function
1	MAIN POWER (N)	12	Sub display PCB connection (DC5V,12V,com1,com2)
2	4Way Valve	13	SMPS PCB connection (DC15V)
3	FAN MOTOR connection	14	Download Main
4	Indoor communication connection	15	SMPS PCB connection (DC5V,12V)
5	N/A	16	Compressor connection (U,V,W)
6	EEV control	17	Reactor
7	Out/Discharge/Cond./OLP temp. sensor	18	SMPS PCB connection (AC220V)
8	DRED PBA connection (* DRED : Demand Response Enabling Device)	19	MAIN POWER (L)
9	Sub display PCB connection (Key, 7-segment signal)	20	EARTH
10	Sub display PCB connection (Key, solution communication signal)	21	Download INV
11	EEPROM connection		

5-2-2 Display PBA

■ AC052MXADKH / AC071MXADKH

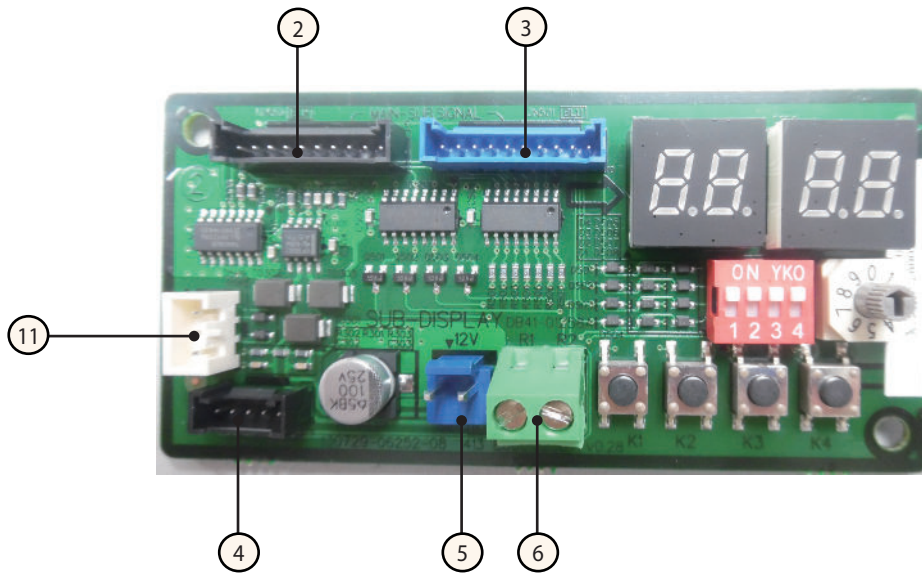

No.	Function
1	MODE SELECTOR
2	MAIN PCB connection (Key, Switch signal)
3	MAIN PCB connection (Key, 7-segment signal)
4	MAIN PCB connection (DC 5V, 12V)
5	DC 12V
6	Solution communication

6. Wiring Diagram

6-1 Indoor Unit

■ AC052MNCDKH / AC071MNCDKH

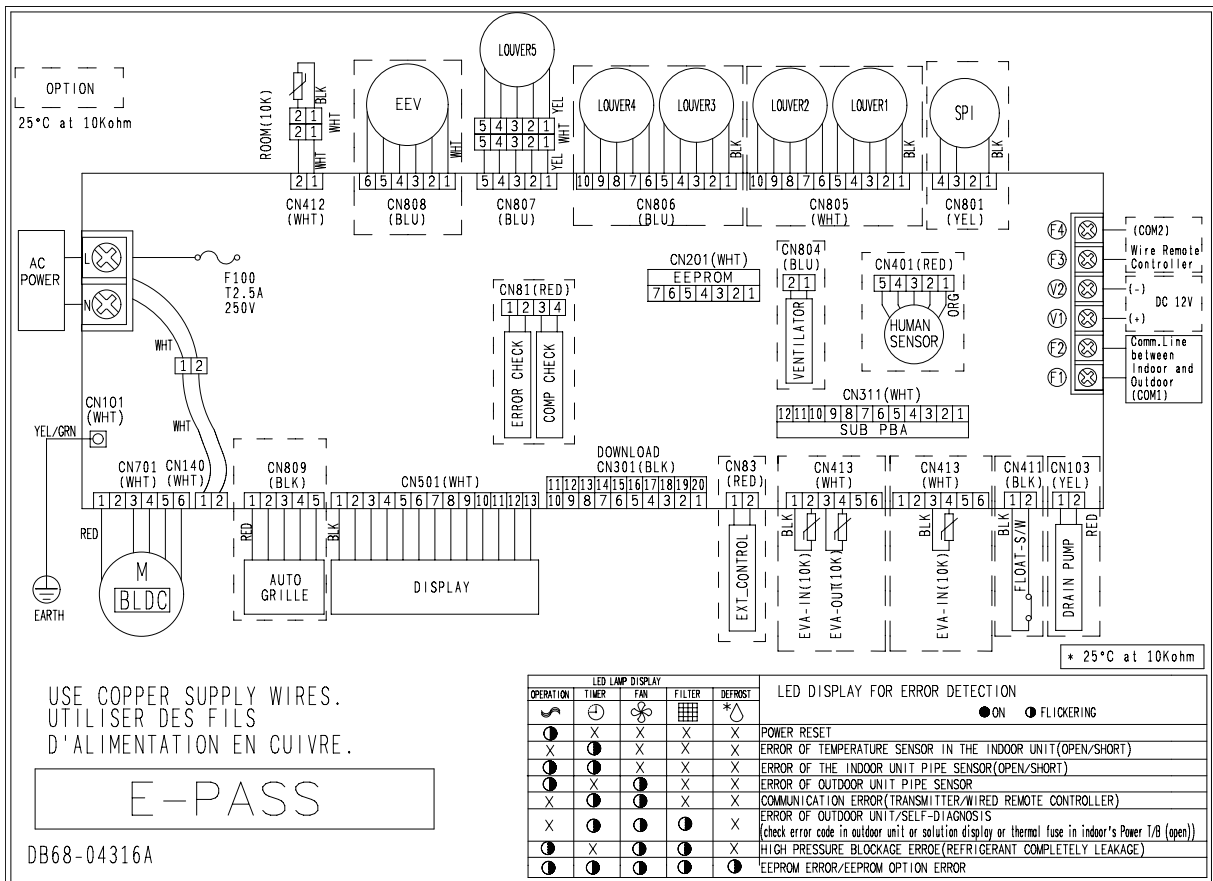

This Document can not be used without Samsung's authorization.

■ AC100MNC DKH / AC120MNC DKH / AC140MNC DKH

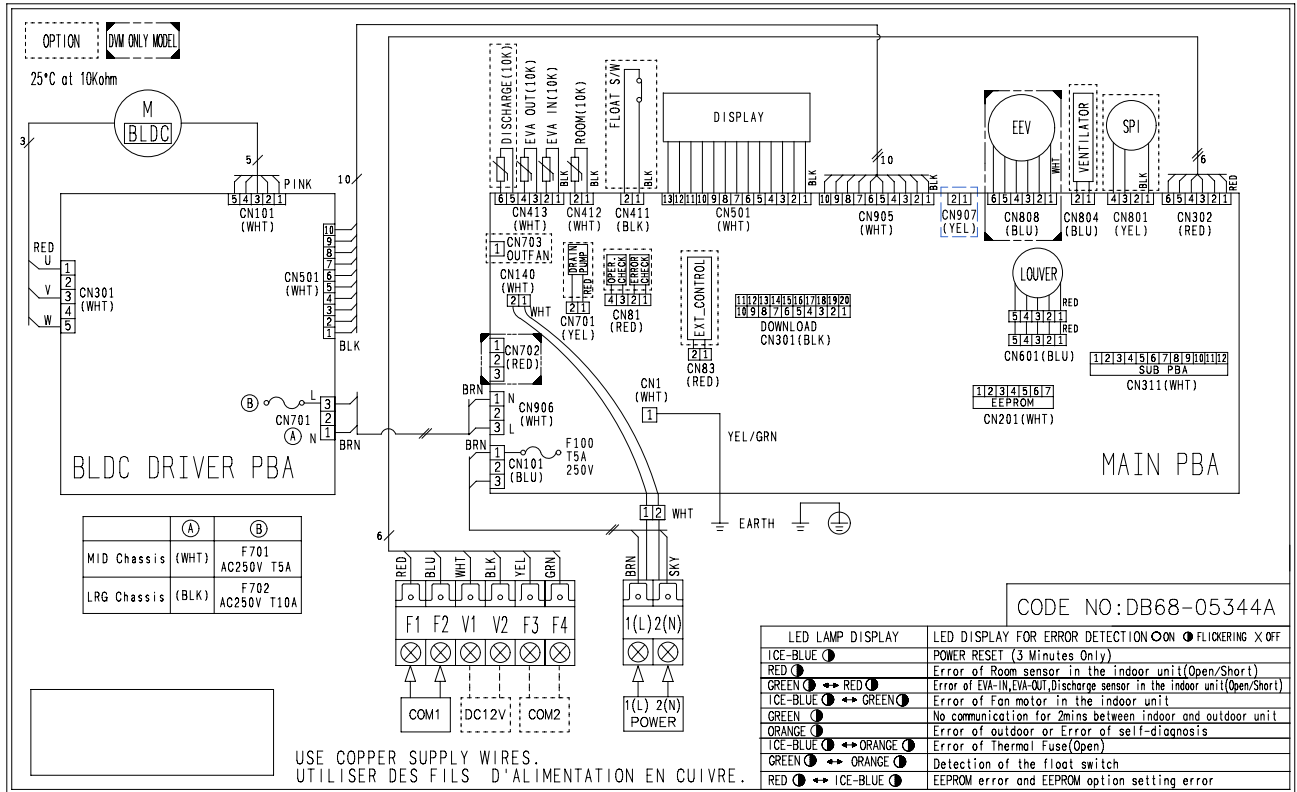

This Document can not be used without Samsung's authorization.

6-2 Outdoor unit

■ AC052MXADKH / AC071MXADKH

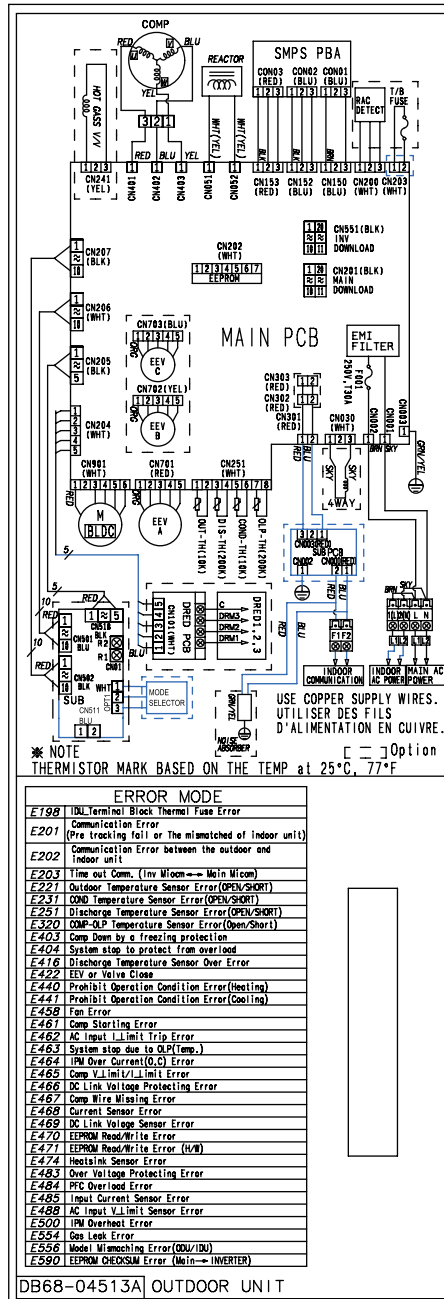

This Document can not be used without Samsung's authorization.

7. Reference Sheet

7-1 Index for Model Name

Model Code

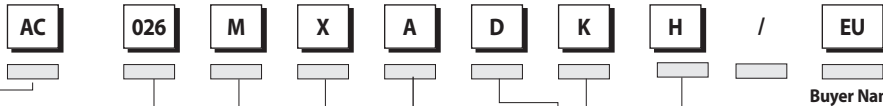

Buyer Name

Capacity (3 DIGIT)
KW / BTU / Liter

Product Type	
Code	Type
AM	DVM
AJ	PMA
AC	CAC (USD) / ASD
AE	EHS
AN	VTL
AK	PAK (Packaged System)
AG	CHR

Product Type	
Code	Type
E	2012
F	2013
H	2014
J	2015
K	2016
M	2017

Rating Voltage	
Code	Type
A	A(115V, 60Hz, 1Φ)
B	B(220V, 60Hz, 1Φ)
C	C(208~230V, 60Hz)
D	D(200~220V, 50Hz)
E	E(220~240V, 50Hz)
F	F(208~230V, 60Hz, 3Φ)
G	G(380~415V, 50Hz, 3Φ)
H	H(380V, 60Hz, 3Φ)
J	J(460V, 60Hz, 3Φ)
K	K(220~240V, 50/60Hz, 1Φ)
M	M(127V, 50Hz)
N	N(380~415V, 50/60Hz, 3Φ)

Refrigerant		
Code	Type	Refrigerant
C	COOLING ONLY	R410a
H	HEAT PUMP	
R	HEAT RECOVERY	R22
D	COOLING ONLY	
E	HEAT PUMP	R134
A	Cooling only	
B	Heat Pump	
N	N/A	

Product Type (Indoor)		Product Type (Outdoor)	
Code	Type	Code	Type
1	1 Way CST	A	Inv+Side+General Temp
2	2 Way CST	S	Inv+Side+Low Temp
N	Mini 4 Way CST	Q	Inv+Side+Tropical Temp
4	4 Way CST	F	Inv+Top+Tropical Temp
H	HSP Duct	B	Non Inv+Side+General Temp
M	MSP Duct	N	Non Inv+Side+Low Temp
L	LSP Duct	R	Non Inv+Side+Tropical Temp
E	Fresh Air Intake Duct	Z	Non Inv+Top+Tropical Temp
G	Ceiling Concealed Duct	U	UNITED STATUS DUCT
C	Ceiling	K	DVM PLUS4
J	Console	V	DVM Inverter
F	Floor Mounting	L	DVM SLIM
P	FAC	G	DVM GHP
V	RAC-Jungfrau	M	DVM MINI
Q	RAC-Neo Forte(EEV)	W	DVM WATER
T	RAC-Neo Forte	C	DVM GEO(GEOTHERMAL)
D	RAC-Domestic	D	DVM PLUS3
R	RAC-Maldive	X	DVM PLUS2
A	RAC-New Model (Slim)	J	FREE JOINT MULTI
7	RAC-Vivace	P	PACK MULTI
U	AIR HANDLING UNIT	H	DVM HOME
Z	AIR HANDLING UNIT	E	SINGLE
Y	HYDRO UNIT	T	MULTI
B	HYDRO UNIT	Y	MONO
X	HYDRO UNIT		
W	WATER TANK		
K	FLAT		
S	STAND		

Product Type (Indoor)		Product Type (Outdoor)	
Code	Type	Code	Type
F	FLAGSHIP	F	FLAGSHIP
P	PREMIUM	P	PREMIUM
D	DELUXE	D	DELUXE <- Basic
S	STANDARD	S	STANDARD
F	CASCADE	L	FLAGSHIP + TROPICAL
G	CASCADE (EEV)	R	PREMIUM + TROPICAL
E	MULTI (/ SOLAR TANK)	T	DELUXE + TROPICAL<- Basic
D	STANDRAD (/ STANDARD TANK)	N	STANDARD + TROPICAL

Product Type	
Code	Type
S	Set (NASA)
N	Indoor (NASA)
X	Outdoor(NASA)
A	Set (NASA)
B	Indoor (No NASA)
C	Outdoor (No NASA)

※ "/" can be removed from the buyer card if there are not enough digits.

7-2 Refrigerating Cycle Diagram

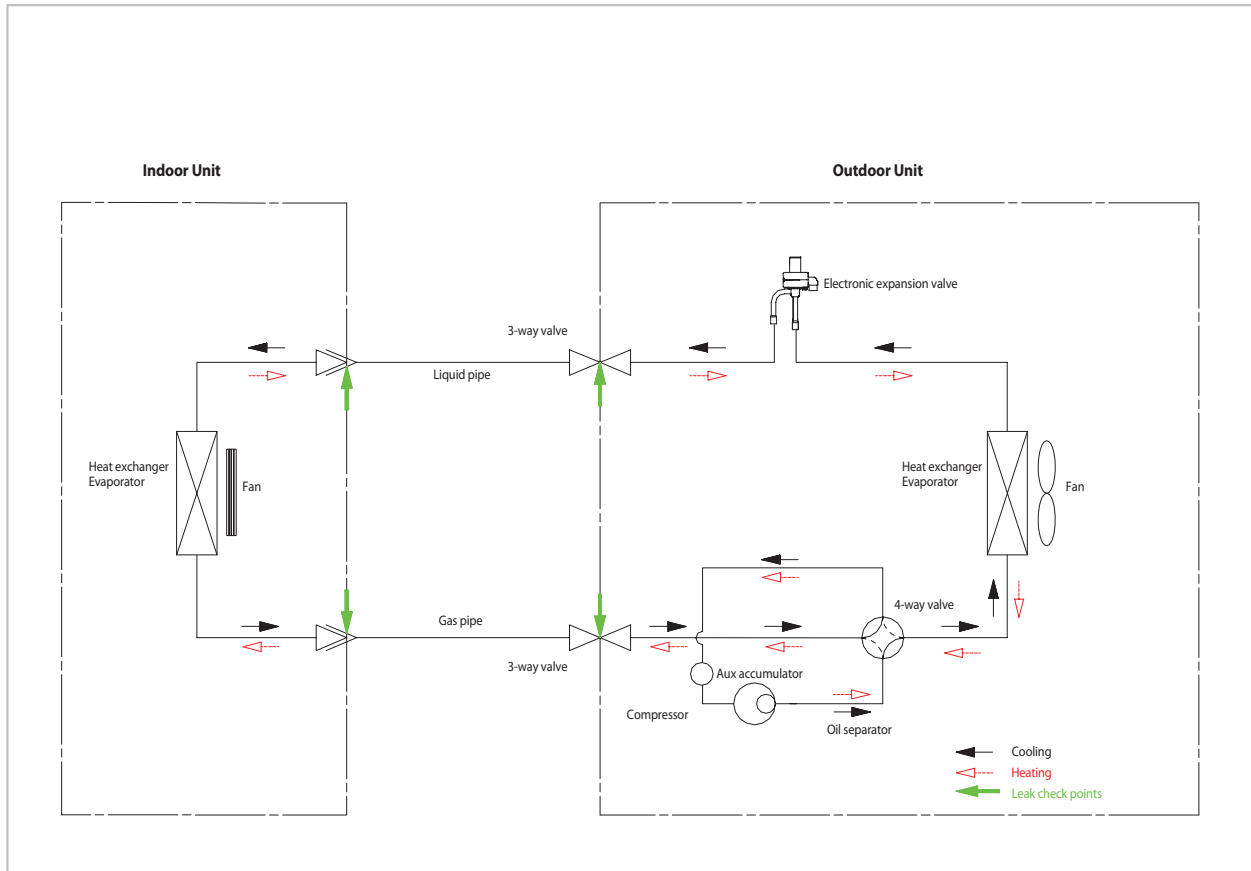

■ CONDENSER

High temperature and high pressure gas state coolant discharged from the compressor is converted to a liquid state as it is cooled down by the heat emission in the outdoor condenser unit, and sent to the evaporator.

■ COMPRESSOR

Low temperature and low pressure coolant is compressed and sent to the cycling system

■ EVAPORATOR

Liquid coolant sucked in through the capillary tubes cools down the room by absorbing the surrounding heat as it evaporates (converting from liquid to gas). (Absorbing heat required for evaporation)

■ SERVICE VALVE

You can open the valve by turning the need valve counterclockwise using hex wrench, and it is used for vacuum, gas purging, coolant injection, coolant purging, and indoor-outdoor unit connection.

■ ACCUMULATOR

Accumulator prevents the flow of liquid-state coolant into the compressor. (Liquid-state coolant flowing into the compressor will overload the compressor.)



This Service Manual is a property of Samsung Electronics Co., Ltd.
Any unauthorized use of Manual can be punished under applicable
International and/or domestic law.

© Samsung Electronics Co., Ltd. Jun. 2016.
Printed in China.